

**CEMO**

for safe storage



Innovative solutions  
for Local authorities | Agriculture |  
Construction industry | Industry

# Products 2022 | 2023

valid from 1/8/2022



Filling stations and tank systems | Pumps | Storage of hazardous substances  
Transportation and storage containers | Winter service | Spreaders | Heating oil storage

[www.cemo-group.com](http://www.cemo-group.com)

# Challenge

## Accepting challenges, seizing opportunities, shaping the future.

Humanity has been faced with great challenges from the very beginning: Everything from the invention of the wheel in prehistoric times to the advent of the printing press in the mid-15<sup>th</sup> century, the first car 150 years ago, the aeroplane, the lunar landing in 1969 and the launch of the World Wide Web in 1989 has changed our world and our way of life. We seized opportunities and shaped the future. New ideas, boldness, willpower and the tenacity brought to bear by individuals helped us to advance.

So it is with CEMO too. We have been providing innovative solutions to our customers for over 60 years, and now count amongst the leading specialists for safe storage, transport and dispensing.

Our challenge is to keep offering you, our customer, new and enhanced products and services while considering the future, sustainability and the environment as well. This is the maxim behind our motto "Your job – our challenge": CEMO simplifies your work, saves time, uses energy efficiently and protects the environment.



### Would you like to refuel your vehicles and devices without being tied to cables?

Now you can with the CAS battery system for our mobile tanks and trolleys! This is because CAS (Cordless Alliance System) means cordless freedom and sustainable solutions for you. Our mobile tanks, trolleys and other product groups with high-performance Li-ion battery packs enable you to work flexibly and safely without cords. What's more, you save money by using the same batteries in multiple applications.

### All components at optimum working height – tank systems from the specialist for professionals!

The new, compact CEMO CUBE 980 L diesel tank system is easy to use. Whether Indoor Basic, Outdoor Premium or Mobil – you benefit from all the advantages: The compact design and optimal working height simplify handling for you, as do the automatic nozzle with dispensing nozzle holder and the forklift pockets for transport. The bunded tank, the visual leak indicator, the filling connection with tanker coupling and over-fill sensor, the bleeding cap and the contents gauge maximise safety.





### How can you improve safety in your company?

The battery fire prevention box with UN certification and non-combustible interior lining stores lithium batteries safely. The boxes are stackable and interconnectable. They may also be transported on public roads, enabling fire-protected storage on the go as well, e.g. on construction sites. Fire prevention is an important consideration when charging lithium batteries. CEMO now offers a safe solution: the new battery storage and charging cabinets. The design incorporating non-combustible, fire-resistant components and special fire protection seals prevents escaping flames.



### Rapid refuelling with the Outdoor diesel tanks:

The new, banded CEMO CUBE 5000 L with high-performance submersible pump. The ideal tank system for shorter refuelling stops. You can choose from two models: Outdoor Basic and Outdoor Premium. They differ in that the Outdoor Premium additionally features a K33 flow meter with water separator and a hose reel (8 m). Both models are banded and feature a visual leak indicator, a filling connection with tanker coupling and overflow sensor, a mechanical contents gauge, and an automatic nozzle with commercial vehicle flow rate in addition to many other benefits.



### The fast way to lush green

Transfer Trolley Aqua: practical solution for watering plants in administrative buildings, hotels and hospitals. For transporting water and for independent watering of plants, totally mobile and wireless. Easy handling thanks to integrated handles and castors.

BWS 130-PE: the irrigation system for universal demands with electrical pump. From 600 to 3,000 litres. Easy to attach and transport. Wide range of accessories.

**NEW**

**CEMO**

for safe storage

## NEW PRODUCTS 2022

### CEMO DT MOBIL EASY

Mobile tank system



**CAS** CORDLESS ALLIANCE SYSTEM

37

### CEMO CUBE 980 L

Stationary tank system for diesel

### CEMO CUBE MOBIL 980 L

Mobile tank system for diesel



23  
45

61

### CEMO transfer trolley

Oil

Blue for AdBlue®

Chem for liquid chemicals

Aqua for irrigation



**CAS** CORDLESS ALLIANCE SYSTEM

83  
105

235

### CEMO KS MOBIL Easy 330 L

Mobile tank systems for petrol



71

### CEMO battery storage and charging cabinet 8/10



198  
199

### CEMO CUBE Slimline 2000 L



24  
79

### CEMO battery storage cabinet FMplus

197



### CEMO workshop trolley

172



### CEMO submersible pump CENTRI SP80

21  
42

119





## FILLING STATIONS / TANK SYSTEMS



	page
Stationary diesel tank systems and fuel dispensing areas, tank monitoring	10 - 30
Mobile diesel tank systems	31 - 61
Mobile diesel and heating oil tanks for heaters and generators	59 - 61
Petrol tank systems, stationary and mobile	62 - 71
Tank systems for lubricants, stationary and mobile	72 - 83
Mobile tank system for screenwash and radiator antifreeze	83
Tank systems for AdBlue® (DEF) stationary and mobile	84 - 105

## PUMPS



Tank data management systems	109 - 110
Diesel dispensing pumps, CUBE pumps, diesel pumps and hose reels	111 - 122
Filters for diesel and petrol	118
Submersible pump for diesel, AdBlue® and water	119 - 120
Hand pumps for diesel, lubricants and petrol	122
Petrol pumps and motorised pumps with petrol engine	123 - 124
Lubricant pumps, electric and pneumatic	125 - 127
Chemical pumps	128 - 131

AdBlue® is a registered trademark of the German Automotive Industry Association

## ENVIRONMENTAL PROTECTION



Spill pallets and spill trays and filling stations made of GRP, PE and steel	135 - 154
IBC bunds and ground protection systems	156 - 161
Drum and hazardous material racks, environmental cabinets and safety containers	162 - 188
Secure cabinets fireproof F-SAFE, fireproof containers F-SAFE	189 - 193
Storage and charging of lithium batteries, battery secure cabinet F90	194 - 201
Transport of lithium batteries	202 - 203
Collection stations, drum depots, suction units, safety storage containers	204 - 211
Go-box for absorbents, portable drum bund, dispensing nozzle holder for drums	212
Filling funnels, bunds, Cemsorb absorbends	213 - 215

## TRANSPORT AND STORAGE CONTAINERS



Tanks, GRP and PE, PE beverage tanks	218 - 229
Mobile irrigation systems, mobile cleaning systems	230 - 237
Water storage tanks PE	238 - 239
Rectangular containers	240 - 245
Transport containers CEMbox	246 - 249
Vehicle storage box, general purpose box GRP and steel, logistics box, Go-box	250 - 252
Boot cleaner, GRP rinsing trays	253

## WINTER SERVICE / SPREADERS



GRP grit container, grit container loading frame	256 - 261
GRP snow shovel, Snow plough, corrosion-resistant PP shovels	262 - 263
Rotary spreaders with PE hopper and composite frame	264
Rotary spreaders with PE hopper, drop spreader with PE hopper	265
Towable spreaders, Spray Caddy	266 - 267
Mounted spreaders with steel and PE hopper	268

**Product group (PG):** Please note the different resale terms for the individual product groups. The relevant product group is indicated on every catalogue page.



# TANK SYSTEMS FOR DIESEL





# Stationary tank systems for diesel (p. 10-30)

## DIESEL TANK GUIDE

Tank series	CUBE				UNI tanks	Steel tanks
Capacity (L)	980	1,000 - 2,500	2,000	5,000	400 - 1,500	4,000 - 30,000
Outdoor	yes	yes	yes	yes	-	yes
Lockable	yes	yes	-	yes	-	-
Certification – stationary use	yes	yes	yes	yes	yes	yes
Transport certification according to ADR	optional	-	-	-	-	-
Forkliftable	yes	-	-	-	yes	-
Ergonomics						
working hight (cm)	120	140	180	145	117 / 142 / 185	-
hose reel	optional	optional	-	optional	-	-
pump capacity (L/min)	56	up to 72	50	up to 80	up to 50	up to 90
Revision dome / Cleaning opening	yes	yes	yes	yes	-	yes
Dimensions	compact	compact	compact		compact	
Material combination		plastic / plastic			steel / plastic	steel / steel
Warranty (years)	10	10	10	10	5	10
Service + Maintenance	yes	yes	yes	yes	yes	yes

### CEMO CUBE 980

- Complete system Basic and Premium
- compact design, easy to operate
- all components at optimum working height



### CEMO CUBE 2000

- Slimline diesel tank
- Double-walled tank with optical leakage detection



### CEMO CUBE

- 1,000 - 15,000 L
- HDPE bunded tank
- installation in buildings and outdoors



### CEMO UNI

- 400 - 4,500 L
- Double-wall tank comprising HDPE inner tank and galvanised sheet steel bund
- indoor installation
- does not require a bund, even in water-protected areas



### CEMO steel tank

- 4,000 - 30,000 L
- above ground tank system, steel double-wall

### CEMO tank monitoring

Fuel level monitoring system, without and with remote monitoring for unpressurised tanks

30



# Stationary tank systems for diesel

## STATUTORY REQUIREMENTS FOR DIESEL FILLING STATIONS FOR OWN CONSUMPTION

The filling station is intended for the refuelling of the company's own vehicles. It is operated by the operator or by instructed persons appointed by the operator, and the total annual output is a maximum 100,000 L. The self-consumption filling station consists of the storage tank and the filling station. A summary of the conditions to be met for a self-consumption filling station is provided below:

The ordinance on facilities for handling substances that are hazardous to water (AwSV) came into force on 1 August 2017. It harmonizes national requirements and replaces the 16 ordinances on facilities for handling substances that are hazardous to water (VAwS) of the individual German states. TRwS 781 (vehicle fuelling stations) will therefore also be regarded nationwide as the generally acknowledged technical regulation in accordance with Sec. 62 (2) of the Water Management Act (WHG). TRwS 781 defines the requirements for self-consumption filling stations.

### A Storage facility

1. Storage containers with test mark or National Technical Certification, single-walled GRP containers up to 2,000 L without bund, but on a subsurface that is impervious to fluid with a 1 cm upstand (e.g. R1 sealing surface elements), also pertains to tank batteries up to 10,000 L; other double-walled containers or in a bund.
2. For installation in the open air, the storage tank must be certified for this purpose. This requirement is met by CEMO CUBE tanks, CEMO GRP tanks and double-walled steel tanks (cf. certification); PE tanks in sheet steel jackets only indoors.
3. Collision protection, for example: guard rails, large stones, high threshold or spray protection walls around the compact fuel dispensing area.
4. Automatic dispensing nozzle is required. Exception: Delivery from storage tanks < 1,000 L is also permitted using manually operated pumps with shut-off valve on the dispensing hose. This also applies to delivery with electrically operated pumps, if the pumps are disconnected from the power network by a manually operated switch during downtimes.
5. Permanently connected filling nozzles with tanker coupling.
6. Certified overfill prevention
7. A syphon lock on the pump is required.
8. No requirement for specialist assistance up to 10,000 L installation size.

9. Fire prevention regulations (distances, ventilation, design of walls and doors, etc.) must be met.

### B Fuel dispensing area

1. Size of the fuel dispensing area: effective range of the nozzle, i.e. minimum hose length plus 1 m, livithable by walls or positively guided filler hose, e.g. compact fuel dispensing area.
2. The retention volume for the delivery devices is arrived at from the pump capacity in L/min x 3 min. For example, a pump with a volume flow of 50 L/min has a retention volume of 150 L. When filling the storage container, a retention volume for the fuel volume is required that will contain the volume of liquid that would be discharged at maximum flow, until the self-activating safety devices take effect. This results in a retention volume of  $R = 0.1 \text{ m}^3$  when filling using a hose coupling, and a retention volume of  $R = 0.9 \text{ m}^3$  when filling using devices with dead man's switch and emergency stop actuator. Contrary to this, the maximum volume dispensing volume and thus the required

retention volume may be reduced at owner-occupied filling stations by means of a non-replaceable restriction, e.g. by a smaller hose diameter.

3. Keep binding agents and fire extinguishers ready.

### Obligations of the operator:

1. Register filling stations with more than 1,000 L with the water authorities below.
2. Inspection prior to commissioning by an expert in accordance with the Water Management Act (WHG) of filling stations with more than 1,000 L to 10,000 L. Periodic inspection (every 5 years) by an expert in accordance with the Water Management Act (WHG) of filling stations with more than 10,000 litres.
3. Obtain construction certification for filling stations with more than 5,000 L.

**These principles apply to above-ground filling stations outside of water conservation areas. We will be happy to advise you for this purpose.**

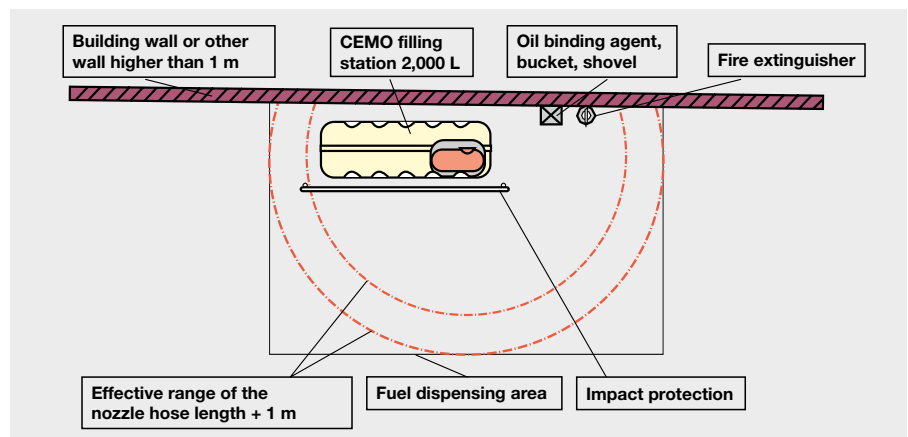

Example: Filling station for own consumption up to 2,000 L

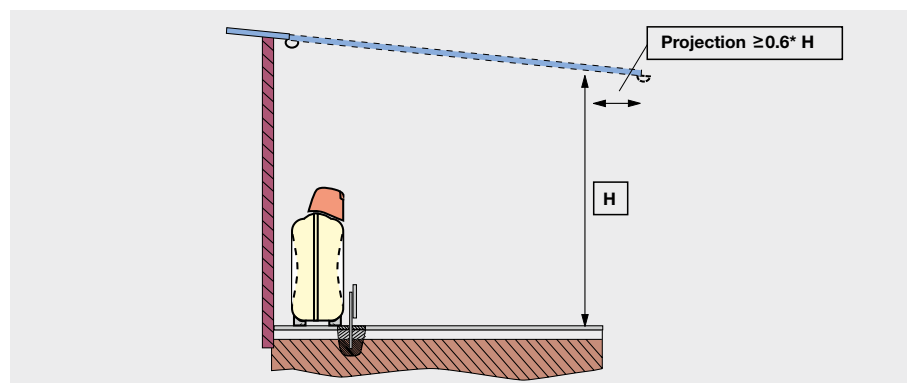

Roof for fuel dispensing areas

# CEMO CUBE

## Stationary tank systems for diesel

Most fuel stations available today have been adapted from oil storage tanks and often give the appearance of being cobbled together as best as possible. Perhaps now is the time to redesign from scratch and produce a purpose- designed fuel station better suited to today's user.

CEMO present the latest in security, function and design in the CUBE. We have introduced features with benefits, not compromises and jigs. The first dispensing station to be designed as a dispensing station with everything in its place, easily accessible and straightforward to use.

It's impressive – a great concept. Take a look and see if you agree.



Video CUBE-Tank



ergonomic

All equipment is positioned so that it is easy to see and access at an optimum level over the bund.



always tidy

The automatic hose reel helps you keep 8 m of hose in order.

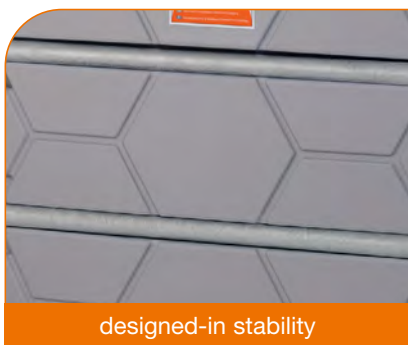

designed-in stability

The honeycomb structure (1,000, 1,500, 2,500, 5,000 L) and steel supports (1,000, 1,500, 2,500 L) result in superior robustness.



double protection

Integral 110 % bund gives added environmental protection.



electric connection access integrated in lid

Cable duct allows easy connection to the electric pump.







large inspection hatch

Hinged lid with 380 mm opening for tank inspection (5,000 L).



cleanliness

The integrated dispensing nozzle holder catches drops after filling.



open on all sides

When open, the lid gives unimpeded access to all components from three sides.

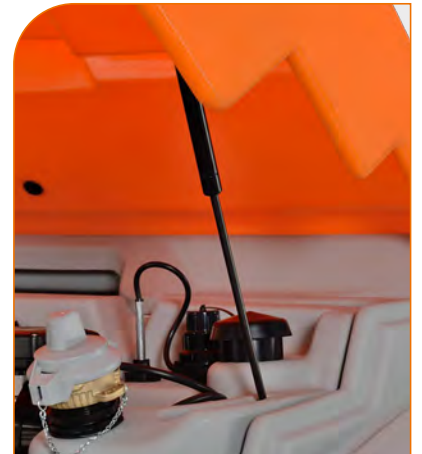

robust, lockable lid

Lockable lid secured by toggle latches. Opens upwards on supporting gas struts to allow access from three sides.



wind damage prevention

Four points for securing the tank to the ground to protect from strong wind damage (5,000 L version)



easy to lift

Three connection points on the circumference for shackles or lifting eyes when being lifted from above (5,000 L version)

CUBE diesel tank 5,000 L  
Outdoor Premium

# CEMO CUBE

## Stationary tank systems for diesel PG 4

Diesel

### Diesel tank dispensing system, Basic and Premium

with general construction inspection certification no. Z-40.21-510

- comprising integrated bund
- visual bund alarm
- tanker coupling
- electronic overfill sensor
- vent
- analogue contents gauge
- suction hose
- 230V pump 56 L/min (72 L/min on 2,500 L versions)
- 4 m delivery hose
- automatic nozzle with integral nozzle holder
- certified for outdoor installation with hinged lid (outdoor model)
- completely assembled



CUBE diesel tank 1,500 L Outdoor

CUBE diesel tank 2,500 L Indoor Basic

### CEMO CUBE diesel tank 2,500 litre Outdoor Premium

- K33 meter
- filter with water separator
- hose reel with 8 m hose DN 19

Order no. 10299

**TOP SELLER**

### CEMO CUBE diesel tank

Description	Capacity L	External dimensions cm (wxdxh)	Weight approx. kg	Order no.
<b>Indoor Basic</b> 4 m dispensing hose DN 19, without hinged lid	1000	120 x 80 x 174	135	10420
	1500	120 x 115 x 174	165	10292*
	2500	120 x 180 x 174	220	10293***
<b>Outdoor Basic</b> 4 m dispensing hose DN 19, with hinged lid	1000	120 x 80 x 180	150	10294*
	1500	120 x 115 x 180	180	10295*
	2500	120 x 180 x 180	235	10296***
<b>Outdoor Premium</b> K33 flow meter, cartridge filter with water separator, hose reel with 8 m hose DN 19, with hinged lid	1000	120 x 80 x 180	170	10297*
	1500	120 x 115 x 180	200	10298*
	2500	120 x 180 x 180	255	10299***
CUBE-Tank Extension I Indoor: CUBE-Tank with integrated bund, with visual bund alarm, filling connection with tanker coupling and overfill prevention sensor, vent, analogue contents gauge, suction hose with connection kit to first tank, completely assembled	1500	120 x 115 x 174	155	10776
	2500	120 x 180 x 174	210	10512
CUBE-Tank Extension I Outdoor: same as CUBE-Tank Extension I Indoor, incl. with hinged lid	1500	120 x 115 x 180	170	10774
	2500	120 x 180 x 180	225	10300
CUBE-Tank Extension II Indoor: same as CUBE-Tank Extension I Indoor, only with connection to CUBE-Tank Extension II	1500	120 x 115 x 174	155	10777
	2500	120 x 180 x 174	210	10544
CUBE-Tank Extension II Outdoor: same as CUBE-Tank Extension II Indoor, incl. with hinged lid	1500	120 x 115 x 180	170	10775
	2500	120 x 180 x 180	225	10545

\* with electric pump 56 L/min    \*\*\* with electric pump 72 L/min (pump output in free flow. Please note that the pump output can fall sharply depending on the length and cross-sectional area of the hose.)

# CEMO CUBE Outdoor PG 4

## Premium Plus and Premium Plus SIM

with tank data management system "CMO 10" and "CMO 20 SIM"

**Diesel tank dispensing system,  
Outdoor Premium Plus 10  
with general construction inspection  
certification no. Z-40.21-510**

- comprising integrated bund
- visual bund alarm
- tanker coupling
- electronic overfill sensor
- vent
- analogue contents gauge
- suction hose
- pump 230 V
- meter with access control and tank data management system "CMO 10" for up to 250 users
- incl. 5 user keys and 1 master key
- hose reel with 8 m hose DN 19
- automatic nozzle with integral nozzle holder
- with hinged lid certified for outdoor installation
- completely assembled

### Outdoor Premium Plus 20 SIM

features as for Outdoor Premium Plus 10, and also:

- for up to 999 users
- access via PIN code
- mileage / operating hours input
- electronic contents gauge
- GPS function
- modem for tank data transmission



CUBE diesel tank 2,500 L Outdoor Premium Plus 20 SIM



① Meter with access control and tank data management system "CMO 10" for up to 250 users

② Additional for Premium Plus 20 SIM: modem for tank data transfer, GPS function for up to 999 users

incl. 5 user and 1 master key



CUBE diesel tank Outdoor Premium Plus 10

Information for the management system see page 19.

## CEMO CUBE diesel tank

Description	Capacity L	External dimensions cm (w x d x h)	Weight approx. kg	Order no.
<b>Outdoor Premium Plus 10</b>	1000	120 x 80 x 180	170	10780*
	1500	120 x 115 x 180	200	10778*
	2500	120 x 180 x 180	255	10736***
<b>Outdoor Premium Plus 20 SIM</b>	1000	120 x 80 x 180	170	11320*
	1500	120 x 115 x 180	200	11321*
	2500	120 x 180 x 180	255	11322***









\* with electric pump 56 L/min    \*\*\* with electric pump 72 L/min (pump output in free flow. Please note that the pump output can fall sharply depending on the length and cross-sectional area of the hose.)

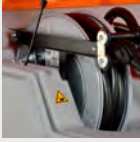

# CEMO CUBE

## Stationary diesel tank systems PG 4

### ACCESSORIES FOR CUBE DIESEL TANK 1,000, 1,500 AND 2,500 L

Description	Order no.
 <p>Hose reel with 8 m hose DN 19</p>	10375
 <p>K33 flow meter, 3-digit tank display</p>	10376
 <p>Filter with water separator</p>	10377
 <p>K33 meter, complete with filter and water separator</p>	10662
 <p>Meter with access control and "CMO 10" tank data management system for up to 250 users, incl. 5 user keys and 1 master key</p>	10745
 <p>Data transfer set with 3 data transfer cards and USB key reader for wireless data transfer to PC, incl. PC software</p>	10746
 <p>Key set with 5 user keys</p>	10747
 <p>LED instrument lighting with motion sensor and battery</p>	10378
<p>Hinged lid, orange, complete with supporting gas struts and mounting accessories</p>	10324

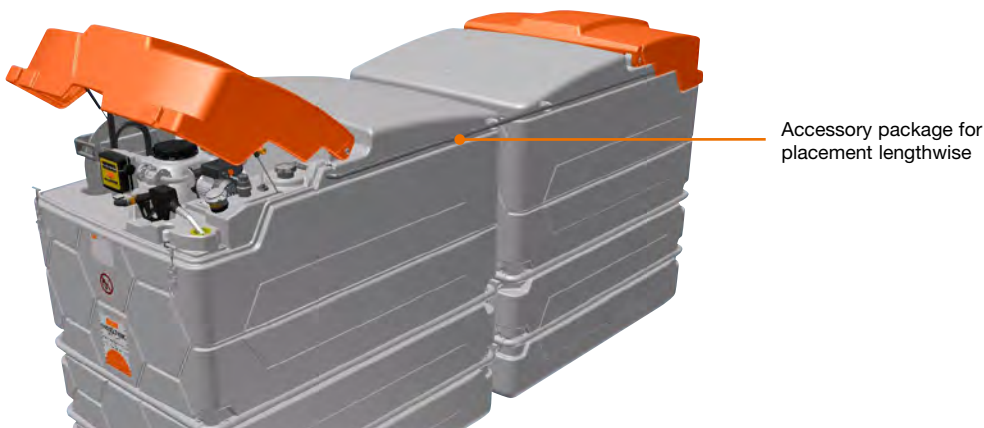

### ACCESSORY FOR CUBE DIESEL TANK SYSTEM 5,000 L

Description	Order no.
<p>Accessory package for placement lengthwise in connection of two CUBE diesel tanks 2,500 L with expansion unit I (see page 14) or CUBE diesel filling stations 5000 L (see page 17)</p>	10666

# CEMO CUBE diesel filling station PG 4

Diesel



CUBE diesel filling station, 5,000 L Outdoor Premium



Filling the CUBE tank systems is this easy.



Dispensing hose with connection to first tank and switching valves included in the expansion kit.

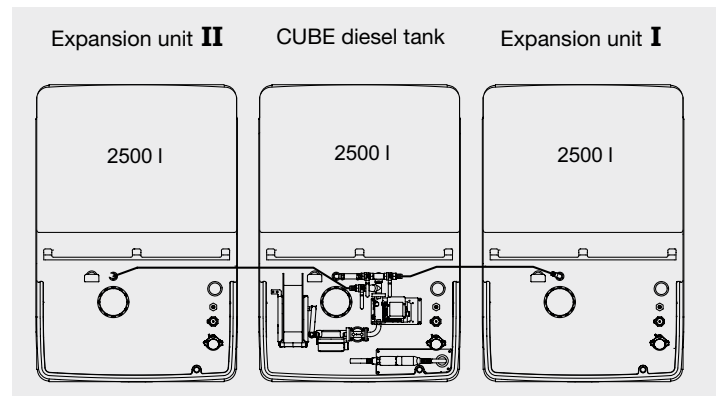

CUBE diesel filling station 7,500 L with expansion unit I and II

## CEMO CUBE DIESEL TANK SYSTEM 5,000 L AND 7,500 L

Description	Comprising	Delivery rate L/min *	External dimensions cm (wxdxh)	Weight approx. kg	Order no.
5,000 L Indoor Basic	CUBE diesel filling station Indoor Basic (10293) and CUBE expansion unit I Indoor (10512)	72	250 x 180 x 174	430	10525
5,000 L Outdoor Premium	CUBE diesel filling station Outdoor Premium (10299) and CUBE expansion unit I Outdoor (10300)	72	250 x 180 x 180	480	10379
7,500 L Indoor Basic	CUBE diesel filling station Indoor Basic (10293), CUBE expansion unit I Indoor (10512) and CUBE expansion unit II Indoor (10544)	72	380 x 180 x 174	640	10546
7,500 L Outdoor Premium	CUBE diesel filling station Outdoor Premium (10299), CUBE expansion unit I Outdoor (10300) and CUBE expansion unit II Outdoor (10545)	72	380 x 180 x 180	705	10547

Accessories see page 16.

\* Pump output in free flow. Please note that the pump output can fall sharply depending on the length and cross-sectional area of the hose.

# CEMO CUBE diesel filling station 5,000 L PG 4

Diesel

**Diesel tank dispensing system, Outdoor Basic and Outdoor Premium with general construction inspection Z-40.21-565**

- with integrated bund
- with visual bund alarm
- filling connection with tanker coupling and overfill prevention sensor
- vent
- contents gauge
- suction hose
- pump 230 V, 72 L/min\*
- automatic nozzle with integral nozzle holder
- with hinged lid certified for outdoor installation
- completely assembled



CUBE diesel tank 5,000 L, Outdoor Basic

CUBE diesel tank 5,000 L, Outdoor Premium

## TOP SELLER

### CUBE diesel tank 5,000 L Outdoor Premium

- capacity 5,000 litre
- pump 230 V
- K33 flow meter, filter with water separator, hose reel with 8 m hose, with hinged lid

**Order no. 11079**

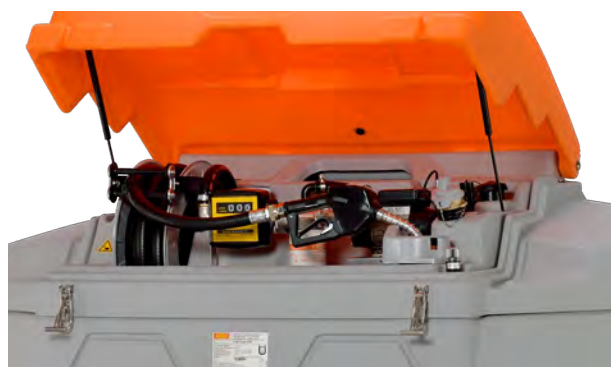

## CUBE DIESEL TANK 5,000 L

Description	Capacity L	External dimensions cm (w x d x h)	Weight approx. kg	Order no.
Outdoor Basic 4 m dispensing hose DN 25, with hinged lid	5,000	240 × 230 × 185	205	11078
Outdoor Premium K33 flow meter, cartridge filter with water separator, hose reel with 8 m hose DN 25, with hinged lid			230	11079
<u>CUBE-Tank Extension I Outdoor</u> CUBE-Tank with integrated bund, with visual bund alarm, filling connection with tanker coupling and overfill prevention sensor, vent, contents gauge, suction hose with connection kit to first tank, completely assembled			201	11081
<u>CUBE-Tank Extension II Outdoor</u> same as CUBE-Tank Extension I Outdoor, only with connection to CUBE-Tank Extension II			201	11096

**Accessories see page 20.** \* Pump output in free flow. Please note that the pump output can fall sharply depending on the length and cross-sectional area of the hose.



# CEMO CUBE diesel tank 5,000 L Outdoor Premium Plus and Premium Plus SIM PG 4

with tank data management system "CMO20"

**Diesel tank dispensing system, Outdoor Premium Plus 20 with general construction inspection certification no. Z-40.21-565**

- with integrated bund
- with visual bund alarm
- filling connection with tanker coupling and overfill prevention sensor
- vent
- contents gauge
- suction hose

- pump 230 V/72 L/min\*
- meter with access control and tank data management system „CMO20“ for up to 999 users, incl. 5 user keys and 1 master key
- hose reel with 8m hose DN 25
- automatic nozzle with integral nozzle holder
- with hinged lid certified for outdoor installation
- completely assembled

**Outdoor Premium Plus 20 SIM\*\*\*** same as Outdoor Premium Plus 20, additional with:

- electronic contents gauge
- GPS function
- modem for tank data transfer

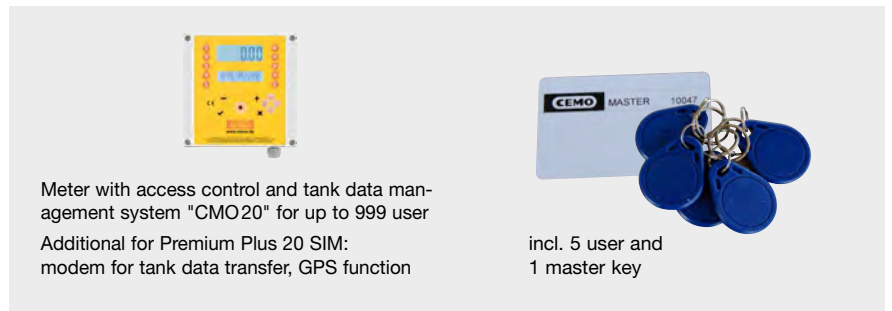

CUBE Diesel tank 5,000 L, Outdoor Premium Plus 20 SIM

## CUBE DIESEL TANK 5,000 L OUTDOOR PREMIUM PLUS AND PLUS SIM\*\*\*

Description	Capacity L	External dimensions cm (w x d x h)	Weight approx. kg	Order no.
Outdoor Premium Plus 20	5000	240 x 230 x 185	212	11323
Outdoor Premium Plus 20 SIM***			212	11324



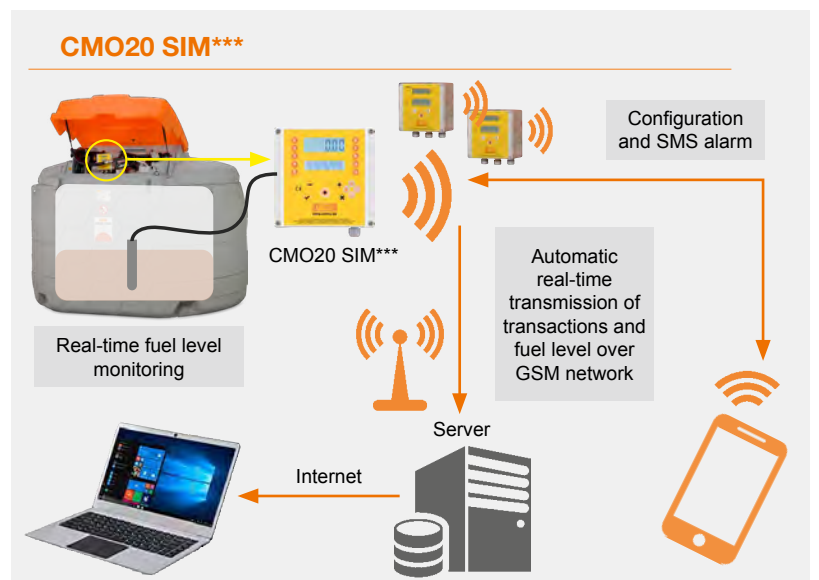





## TANK SYSTEMS PREMIUM PLUS AND PLUS SIM\*\*\* WITH MANAGEMENT SYSTEM CMO10 AND CMO20



Accessories see page 20. \* Pump output in free flow. Please note that the pump output can fall sharply depending on the length and cross-sectional area of the hose.

# CEMO CUBE diesel tank PG 4

## ACCESSORIES FOR CUBE DIESEL TANK 5,000 L (SUPPLIED AS COMPONENTS)

Description	Order no.	
	Hose reel with 8 m hose DN 25	11092
	K33 flow meter, 3-digit tank display	10376
	Cartridge filter with water separator	11093
	K33 flow meter complete with filter and water separator	11094
	Meter with access control and "CMO 10" tank data management system for up to 250 users, incl. 5 user keys and 1 master key	10745
	Data transfer set with 3 data transfer cards and USB key reader for wireless data transfer to PC, incl. PC software	10746
	Key set with 5 user keys	10747
	LED instrument lighting with motion sensor and battery	10378
	Hinged lid, orange, complete with supporting gas struts and mounting accessories	11095



# CEMO CUBE diesel tank 5000 L

with high-performance submersible pump CENTRI SP 80 AC, 230 V. PG 4

## Outdoor Basic and Outdoor Premium tank systems

with General Construction Inspection Certification Z-40.21-565

- bundled
- with visual leak indicator
- filling connection with tanker coupling and over-fill sensor
- mechanical contents gauge
- high-performance submersible pump CENTRI SP 80 AC, 230 V, 80 L/min\*
- automatic nozzle A120 with commercial vehicle flow rate (not suitable for passenger vehicles)
- with lockable lid, certified for installation outdoors
- fully assembled, 5 m connection cable



Diesel



Outdoor **Basic**

**CEMO submersible pumps: the superior pumping principle for your tank system. Simple, fast and safe.**

- Run time limitation: automatic switch-off after preset time
- easy start-up: stands on the tank bottom – no suction height
- submersible centrifugal pump Ø 130 mm, suitable for common tanks and IBCs
- voltage 230 V/50 Hz, power 800 W
- high flow rate
- motor thermally protected
- connection 1" IT without check valve



Outdoor **Premium**

**Higher flow rate for shorter refuelling stops.**

Description		External dimensions in cm (w x d x h)	Weight (approx.) in kg	Order no.
<b>CUBE</b> diesel tank 5,000 L Outdoor Basic, 4 m dispensing hose DN 25, effective delivery rate approx. 70 L/min	<b>NEW</b>	240 x 230 x 185	205	11649
<b>CUBE</b> diesel tank 5,000 L Outdoor Premium, flow meter K33, filter with water separator, hose reel with 8 m dispensing hose DN 25, effective delivery rate approx. 60 L/min	<b>NEW</b>	240 x 230 x 185	230	11650

Accessories see page 20. \* Pump output in free flow. Please note that the pump output can fall sharply depending on the length and cross-sectional area of the hose.

# CEMO CUBE diesel tank system PG 4

Diesel



CUBE diesel tank system 10,000 L Outdoor Premium



Suction hose with connection to first tank and switching valves included in the expansion unit.

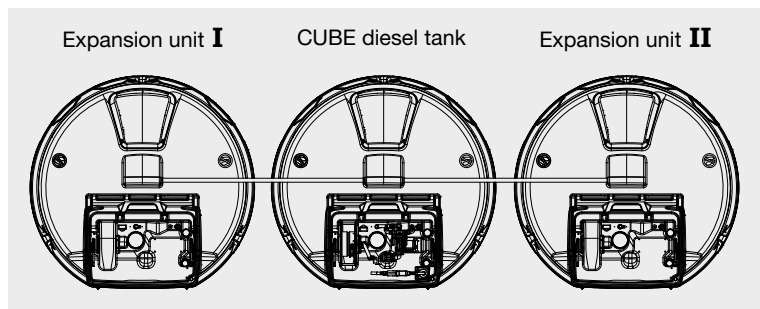

CUBE diesel filling station 15,000 L with expansion unit I and II

## CUBE DIESEL TANK SYSTEM 10,000 L AND 15,000 L

Description	Comprising	Delivery rate L/min *	External dimensions cm (wxdxh)	Weight approx. kg	Order no.
10,000 L Outdoor Premium	CUBE diesel dispensing station Outdoor Premium (11079) and CUBE expansion unit I Outdoor (11081)	72	500 x 230 x 185	413	11097
15,000 L Outdoor Premium	CUBE diesel dispensing station Outdoor Premium (11079) and CUBE expansion unit I Outdoor (11081) and CUBE expansion unit II Outdoor (11096)	72	760 x 230 x 185	614	11098

Accessories see page 20.

\* Pump output in free flow. Please note that the pump output can fall sharply depending on the length and cross-sectional area of the hose.



# Stationary tank systems for diesel

## CEMO CUBE 980 L PG 4

**Complete station, Basic and Premium with General Construction Inspection Certification Z-40.21-589**

compact design, easy to use

- all components at optimum working height
- with integral bund
- with visual leak indicator
- filling connection with tanker coupling and limiting value transmitter
- bleeding cap
- contents gauge
- 1" suction hose
- pump 230 V, 56 L/min\*
- automatic nozzle with dispensing nozzle holder
- with lockable lid, certified for installation outdoors (Outdoor versions)
- with forklift pockets for internal transport
- fully assembled
- for version with ADR certification see page 45



**tank with integral bund offers twice the safety**



**Indoor Basic**  
4 m dispensing hose DN 19, without lockable lid



**Outdoor Basic**  
4 m dispensing hose DN 19, with lockable lid



**Indoor Premium** Flow meter K33, filter with water separator, hose reel with 8 m hose DN 19, without lockable lid



**Outdoor Premium** Flow meter K33, filter with water separator, hose reel with 8 m hose DN 19, with lockable lid

Description	External dimensions in cm (l x w x h)	Weight (approx.) in kg	Order no.
<b>Indoor Basic</b> 4 m dispensing hose DN 19, without lockable lid	130 x 112 x 118	107	11628
<b>Outdoor Basic</b> 4 m dispensing hose DN 19, with lockable lid	130 x 112 x 118	119	11629
<b>Indoor Premium</b> Flow meter K33, filter with water separator, hose reel with 8 m hose DN 19, without lockable lid	130 x 112 x 118	130	11630
<b>Outdoor Premium</b> Flow meter K33, filter with water separator, hose reel with 8 m hose DN 19, with lockable lid	130 x 112 x 118	141	11631

\* Pump output in free flow.  
Please note that the pump output can fall sharply depending on the length and cross-sectional area of the hose.

# Dieseltank

## CEMO CUBE Slimline 2000 L PG 4

Diesel

### Outdoor safety package CUBE Slimline 2000 L

Double-walled tank with visual leak detection. Certified for outdoor installation without leak detection device, even in water protection areas!

Consists of:

- CUBE tank Slimline 2000 L (order no. 11664)
- Accessory pack for outdoor installation (order no. 7355)
- pump approx. 50 L/min, 230 V (self-priming)
- Mechanical flow meter
- Automatic nozzle
- 4 m extension hose DN 19
- installed within a protective housing (order no. 7354)



- contents gauge
- tanker coupling
- robust connection flange
- for outdoor installation
- overfill prevention sensor
- integral bund with leakage detector
- easy tank cleaning
- also certified for biodiesel

Description	External dimensions in cm (l x w x h)	Weight (approx.) in kg	Order no.
Outdoor safety package CUBE Slimline 2000 L	86 x 212 x 211	210	11682





**Available from September 2022**

### CUBE SLIMLINE 2000 L WITHOUT ACCESSORIES

Description	External dimensions in cm (l x w x h)	Weight (approx.) in kg	Order no.
CUBE Slimline 2000 L	86 x 180 x 180	180	11664

**Available from September 2022**

### PUMPS AND ACCESSORIES, DESIGNED FOR CUBE SLIMLINE 2000 L

Description	Order no.
 <p>Accessory pack for indoor and outdoor installation (on single tank), consisting of: dome lid, vent cap, overfill prevention sensor, filling connection, suction hose with foot valve, installation instructions suitable for electric pump 50 L/min in protective box, order no. 7354</p>	7355
 <p>Pump approx. 50 L/min, 230 V (self-priming), mechanical flow meter, automatic nozzle with type certification, 4 m hose, in protective box</p>	7354
 <p>Extension hose DN 19 with 1" connection for electric pump approx. 50 L/min</p>	2 m 7071
<p>For additional hose lengths, see page 118</p>	4 m 7072
 <p>Dome lid steel with two angled threaded nipples 2", for filling and venting, 2 straight threaded nipples 2" and 1", TW coupling and vent cap</p>	1451
 <p>Tank heater type TH 370, 230 V, dia. 44 mm for electric heating of EL grade heating oil and diesel fuel power 0.22 kW, thermostatically controlled, prevents separation of paraffins at low temperatures</p>	8126

# CEMO UNI-Tank diesel filling stations PG 4

## Single tank

- from HDPE with integral galvanised sheet steel bund and base pallet
- standard accessories: contents gauge, visual leakage detector, integral carrying handles
- **no pump**
- for storage of diesel, biodiesel, without additional bund, even in water-protected areas\*
- certified for installation indoors
- can be filled with dispensing nozzle (except Uni-Tank 1,500 L)
- **low overall height (up to 1,000 L), thus no step is necessary**



UNI-Tank 1,000 L



## UNI-TANK

Capacity L	Dimensions cm (l x w x h)	Certification no.	Weight approx. kg	Order no.
400	73 x 70 x 117	Z-40.21-365	50	7979
750	98 x 77 x 142	Z-40.21-288	66	7379
1,000	128 x 77 x 142	Z-40.21-288	89	7380
1,500	163 x 77 x 185	Z-40.21-432	151	7881

Accessories see page 27.

## Diesel tank system

### with UNI-Tank 1,000 L or 1,500 L

Tank system comprising:

- UNI-Tank 1,000 L (7380) or 1500 L (7881), 1, 2 or 3 tanks
- filling connection with tanker coupling (7390)
- overfill prevention sensor (1437),
- extraction pipe and vent
- 240V pump 50 L/min
- components not fitted to tank to avoid transport damage
- pump 230 V self-priming with automatic nozzle, dispensing nozzle holder, meter, 4 m dispensing hose and ventilation
- other lengths for dispensing hose optional, see page 116
- individual filling of the tanks via fixed tanker connection, extraction and venting via common lines



UNI-Tank 1,500 L with pump 230 V 50 L/min



Diesel tank system with 2 UNI-Tanks 1,500 L (Order no. 8822)

## DIESEL TANKS SYSTEMS WITH UNI-TANK 1,000 L OR 1,500 L

Capacity L	Number of UNI-Tank 1000 L	Delivery rate L/min	Dimensions cm (l x w x h)	Weight approx. kg	Order no.
1,000	1	50	166 x 77 x 159	114	10224
2,000	2	50	166 x 157 x 159	206	10225
3,000	3	50	166 x 237 x 159	298	10226

Capacity L	Number of UNI-Tank 1500 L	Delivery rate L/min	Dimensions cm (l x w x h)	Weight approx. kg	Order no.
1,500	1	50	201 x 77 x 202	176	8821
3,000	2	50	201 x 157 x 202	330	8822
4,500	3	50	201 x 237 x 202	484	8823

\* National installation laws and conditions must be observed.



# CEMO UNI-Tank diesel filling stations PG 4

Diesel

## Basic package UNI-Tank 1,000 L

- UNI-Tank 1,000 L (order no. 7380)
- pump 230 V, approx. 30 L/min effective (order no. 8639)
- 4 m connecting cable
- 6 m hose, may be sectioned into suction and dispensing hose
- suction filter
- automatic nozzle

Accessory:

- K24 digital flow meter (8644) see page 27

**Order no. 8683**



**TOP SELLER**

## Basic package Premium 1,000 L

comprising:

- diesel tank UNI 1,000 L (order no. 7380)
- pump 230 V, self-priming, approx. 50 L/min (order no. 7768)
- pump bracket (order no. 7631)
- automatic nozzle
- 4 m connecting cable
- suction hose with foot valve
- nozzle holder
- hose clamp (order no. 10252)

Accessory:

- K33 flow meter (order no. 7779 and 7984) see page 116
- electric flow meter FMT 3/50 (order no. 7574) see page 27



## BASIC PACKAGES UNI-TANK

Description	Order no.
Basic package 1,000 L	8683
Basic package Premium 1,000 L	10239

# CEMO UNI / MULTI diesel tanks PG 4

## PUMPS AND ACCESSORIES SPECIALLY DESIGNED FOR UNI- AND MULTI-TANK

### ACCESSORIES

Description	Order no.
 <p>Hand pump, dispensing volume 25 L/min suitable for UNI-/MULTI-Tank up to 1,000 L</p>	1452
 <p>Pump 12 V, not self-priming, approx. 30 L/min effective, 4 m connecting cable with crocodile clips, 6 m hose, dispensing nozzle</p>	8640
 <p>Pump 230 V, not self-priming, approx. 35 L/min effective, 4 m connecting cable, 6 m hose, dispensing nozzle</p>	8638
 <p>Pump 12 V, not self-priming, approx. 25 L/min effective, 4 m connecting cable with crocodile clips, 6 m hose, automatic nozzle</p>	8641
 <p>Pump 230 V, not self-priming, approx. 30 L/min effective, 4 m connecting cable, 6 m hose, automatic nozzle</p>	8639
 <p>K24 digital flow meter can be calibrated, measuring range 10-120 L/min, 5-digit display, 6-digit total delivery display, inlet and outlet 1" external thread, with 1" steel coupling</p>	8644
 <p>Dispensing hose for electric pump CENTRI Additional DN19 hose, priced per meter (the standard 6m hose is still included in the pump kit)</p>	11351
 <p>Electric pump approx. 50 L/min suitable for UNI-/MULTI-Tank 750 L and 1,000 L 230 V (self-priming), with foot valve, automatic nozzle, 4 m dispensing hose, pump bracket</p>	7573
 <p>Electronic flow meter FMT 3/50 for electric pumps 50 L/min, display can be rotated in 90° steps</p>	7574
 <p>Extension hose DN 19 *** (with 2 x 1" thread) for electric pump approx. 50 L/min</p>	2 m 4 m 7071 7072
 <p>Fixed tanker coupling suitable for UNI-/MULTI-Tank 750 L, 1,000 L and 1,500 L with tanker coupling, vent pipe and overflow prevention sensor</p>	7857
 <p>Pump bracket suitable for UNI-/MULTI-Tank 750 L and 1,000 L for mounting Cematic pumps</p>	7631
 <p>230V pump, approx. 50 L/min (self-priming) with flow meter, suction hose, automatic nozzle, nozzle holder, 4 m dispensing hose, mounted on the bracket and can be hung on the side of the UNI-/MULTI tank</p>	8162
 <p>Tank heater type TH 370, 230 V, dia. 44 mm for electric heating of EL grade heating oil and diesel fuel power 0.22 kW, self-regulating, prevents separation of paraffins at low temperatures</p>	8126
 <p>Hose bracket suitable for UNI-/MULTI-Tank 750 L, 1000 L and 1500 L</p>	10252
 <p>Ultrasonic contents gauge, suitable for UNI-/MULTI-Tank, all sizes</p>	10275

\*\*\* For additional hose lengths, see page 116

# CEMO diesel tank stations with steel tank PG 4

## Above ground tank system

steel double-wall for outdoor installation, certified for the storage of diesel fuel and biodiesel

Construction:

- manufactured in accordance with DIN 6616/D or DIN 6624 or DIN EN 12285 (on request)
- welded on saddle feet
- painted externally with primer and top coats
- ladder (5,000 L model no ladder due to low overall height)
- dip stick
- extraction pipe in dome lid
- anti-siphon device
- bund alarm with liquid control
- overfill prevention sensor
- completely assembled
- factory test certificate

## Options:

- paint schemes according to customer specification possible (additional charge)
- The standard containers are primed and painted. We offer a 10-year warranty against rusting through.



Steel tank fitted with optional bracket and suction hose for diesel dispensing pumps



## STEEL TANK WITHOUT ACCESSORIES

TANK SYSTEM AS DESCRIBED ABOVE.

Capacity L	Dimensions cm (l x w x h)*	Tank ø cm	DIN	Weight approx. kg	Order no.
4000	240 x 165 x 225	160	6616/D	1100	7580
5000	445 x 130 x 190	125	6624	1250	7376
7500	390 x 175 x 225	160	6616/D	1800	7377
10000	520 x 175 x 225	160	6616/D	2200	7378
15000	780 x 175 x 225	160	6616/D	3000	8140
20000	668 x 215 x 266	200	6616/D	3800	8141
30000	982 x 215 x 266	200	6616/D	5200	8142

\* with ventilation pipe

## STEEL TANK WITH BRACKET FOR DIESEL DISPENSING PUMPS

TANK SYSTEM AS DESCRIBED ABOVE, ADDITIONALLY EQUIPPED WITH BRACKET AND EXTRACTION PIPE FOR DIESEL DISPENSING PUMPS (SEE PAGE 111), COMPLETELY MOUNTED. THE DIESEL DISPENSING PUMPS MUST BE ORDERED SEPARATELY.

Capacity L	Dimensions cm (l x w x h)*	Tank ø cm	DIN	Weight*** approx. kg	Order no.
4000	290 x 165 x 225	160	6616/D	1130	8591
5000	495 x 130 x 190	125	6624	1280	8592
7500	440 x 175 x 225	160	6616/D	1830	8593
10000	570 x 175 x 225	160	6616/D	2230	8594
15000	830 x 175 x 225	160	6616/D	3030	8595
20000	718 x 215 x 266	200	6616/D	3830	8596
30000	1032 x 215 x 266	200	6616/D	5230	8597

Prices w/o dispensing pump but incl. assembly \* with vent pipe and bracket \*\*\* without dispensing pump



# CEMO diesel filling stations with steel tank PG 4

Diesel

## Pump 230 V, CUBE 70 K33

- self-priming
- pump dispensing volume approx. 70 L/min
- flow meter with cumulative meter and single-use meter
- 4 m dispensing hose, automatic nozzle
- installed within a protective housing



Pump 230 V, CUBE 70 K33  
(details / accessories see page 113)

## Pump 230 V, CUBE 70 MC50

- self-priming
- pump dispensing volume approx. 70 L/min
- electronic flow meter with 50 user codes
- 4 m dispensing hose, automatic nozzle
- installed within a protective housing



Pump 230 V, CUBE 70 MC50  
(details / accessories see page 113)

## STEEL TANK WITH PUMP 230 V, CUBE 70 K33

TANK SYSTEM AS DESCRIBED ON PAGE 28, ADDITIONALLY EQUIPPED WITH PUMP SYSTEM AND EXTRACTION PIPE, WITH COMPONENTS FULLY MOUNTED

Capacity L	Dimensions cm (l x w x h)*	Tank ø cm	DIN	Weight approx. kg	Order no.
4000	270 x 165 x 225	160	6616/D	1130	7859
5000	475 x 130 x 190	125	6624	1280	7860
7500	420 x 175 x 225	160	6616/D	1830	7861
10000	550 x 175 x 225	160	6616/D	2230	7862
15000	810 x 175 x 225	160	6616/D	3030	8143
20000	698 x 215 x 266	200	6616/D	3830	8144
30000	1012 x 215 x 266	200	6616/D	5230	8145

\* with vent pipe



## STEEL TANK WITH PUMP 230 V, CUBE 70 MC50

TANK SYSTEM AS DESCRIBED ON PAGE 28, ADDITIONALLY EQUIPPED WITH PUMP SYSTEM AND EXTRACTION PIPE, WITH COMPONENTS FULLY MOUNTED

Capacity L	Dimensions cm (l x w x h)*	Tank ø cm	DIN	Weight approx. kg	Order no.
4000	270 x 165 x 225	160	6616/D	1130	7863
5000	475 x 130 x 190	125	6624	1280	7864
7500	420 x 175 x 225	160	6616/D	1830	7865
10000	550 x 175 x 225	160	6616/D	2230	7866
15000	810 x 175 x 225	160	6616/D	3030	8146
20000	698 x 215 x 266	200	6616/D	3830	8147
30000	1012 x 215 x 266	200	6616/D	5230	8148

\* with vent pipe

## ACCESSORIES FOR DIESEL TANK STATIONS WITH STEEL TANK

Description	Order no.
 <p>Level measurement unit pneumatic, for retrofitting</p>	7565
 <p>Level indicator OCIO for diesel, 230 V An innovative system for management of the liquid level in tanks at atmospheric pressure. Special features: continuous measurement, display of heights, volumes and refill percentages, minimum and maximum level alarms, high accuracy, simple installation, simple software configuration</p>	7795

**Delivery / shipping costs for a one-off delivery:** Delivery ex works. When a delivery is made the customer must provide a crane or forklift for unloading. Be sure to take the weight of the tank into account.

# CEMO tank monitoring PG 4

## FILL CONTENTS GAUGES AND TANK MONITORING UNITS WITH DATA TRANSFER FOR UNPRESSURISED TANKS

Description / Capacity L	Order no.
 <p>Level measurement unit pneumatic, for diesel</p>	7565
 <p>Level measurement unit pneumatic, for AdBlue®</p>	8020
 <p>Mechanical contents gauge with float for diesel and water. No free aperture on tank required.</p>	10717
 <p>Fill level indicator With ultrasonic technology "Visual" <b>Data transmission by radio waves at 433 MHz</b>, range 200 m, bars indicate fill level at the tank sensor and the indoor receiver. The receiver is plugged into a 230 V socket. Suitable for tanks with out internal fittings in the ultrasonic cone of 30° e.g. UNI-tank or CUBE-tank.</p>	10275
 <p>Contents gauge Piusi OCIO for diesel, 230 V An innovative system for management of the liquid level in tanks at atmospheric pressure. Special features: continuous measurement, display of heights, volumes and refill percentages, minimum and maximum level alarms, high accuracy, simple installation, simple software configuration, PC connection possible</p>	7795
<p>Contents gauge Piusi OCIO for oil, 230 V, IP55</p>	7796
<p>Contents gauge Piusi OCIO for AdBlue®, 230 V, IP55</p>	10219
 <p>Fill contents gauge GOK SmartBox 1, 230 V, IP54, without sensor Displays fill level in millimeters, litres and percentage as well as free capacity in litres</p>	11172
<p><b>Analogue data transfer module 4 - 20 mA</b>, for SmartBox</p>	8394
<p>Fill contents gauge GOK SmartBox 4, 230 V, IP54, without sensor Fill level displayed in millimetres, litres and per cent and free capacity in litres, <b>data transfer via GSM</b> as SMS or email, depending on provider, required SIM card not included. Event signal input, e.g. to report a system fault. 1 relay with make/break contact</p>	11173
 <p>GOK SmartBox 4 Pro display unit, 230 V, IP54, without probe Connection of up to four probes, otherwise 11173</p>	11174
<p>GOK SmartBox 4 LAN display unit, 230 V, IP30, without probe Fill level displayed in millimetres, litres and per cent and free capacity in litres, <b>data transfer via LAN connection</b> to a local network. Event signal input, e.g. to report a system fault. 1 relay with make/break contact</p>	11175
<p>GOK SmartBox 4 LAN Pro display unit, 230 V, IP30, without probe Connection of up to four probes, otherwise 11175</p>	11176
 <p>LAN PC set for SmartBox 4 LAN, software (CD) and licence Display on PC and evaluation functions for one tank: Extraction curve, consumption table, litre logbook, alerts. Data relaying via automatic email</p>	11177
<p>LAN PRO PC set for SmartBox 4 LAN, software (CD) and licence Display on PC and evaluation functions for max. 56 tanks</p>	11178
 <p>Pressure probe, stainless steel LC 0 - 250 mbar for SmartBox, 6 m cable, with mounting set, GKL 1 %</p>	11179
 <p>Cable junction box, IP66, breathable, for SmartBox Required when the indicator is installed more than 6 m from the bottom of the tank</p>	11180

Sensors for special media and other pressure ranges for the SmartBox available on request.

Additional interfaces for smart box can be optionally retrofitted e.g. B. 4-20 mA, 0-5 V, M-Bus, H-Protocol

# Mobile tank systems for diesel (pp. 31-61)

## Refuelling tanks



from  
**34**

**CEMO Diesel trolley**  
• 60L + 100L



from  
**36**

**CEMO DT-MOBIL EASY**  
**CEMO DT-MOBIL EASY COMBI**  
• 125 - 980L



**45**

**CEMO CUBE MOBIL**  
• 980L

## Heavy duty refuelling systems



from  
**47**

**CEMO DT-MOBIL PRO**  
**CEMO DT-MOBIL PRO COMBI**  
• 980, 980/200, 850/100 or 440, 440/50 L



from  
**55**

**CEMO DT-MOBIL**  
• 400 - 980L



**58**

**CEMO DT-MOBIL HORIZONTAL**  
• 980 - 3.000L

## Generator tanks



**59**

**CEMO MULTI TANK**  
• 400 - 1.500L



**60**

**CEMO DT-MOBIL EASY generator tank**  
210 - 980L



**61**

**CEMO DT-MOBIL PRO generator tank**  
• 440 + 980L  
**CEMO CUBE MOBIL generator tank**  
• 980L

**CEMO diesel and heating oil trolley**  
• 60L + 100L

**60**





# Mobile tank systems for diesel

## IMPORTANT LEGAL REGULATIONS FOR MOBILE TANK SYSTEMS

Diesel

### Legal basics

Mobile tank stations for diesel fuel and petrol are used in many businesses. The legal basics are governed in the ADR (European Agreement Concerning the International Carriage of Dangerous Goods by Road), the GGVSEB (German Regulation Concerning the Transport of Dangerous Goods by Road and Rail) and the GGBefG (German Dangerous Goods Transportation Act). If the container is used as a fixed tank station, the filling station regulations for own consumption are applicable, see page 11.

### Use of mobile diesel or petrol tank systems/IBC

According to the regulations on hazardous goods, mobile tank systems do not exist. They are so-called IBCs. The abbreviation IBC stands for Intermediate Bulk Container. IBCs are used in various sectors for transport and storage, including the transport and storage of hazardous goods. They are filled with fluid or pourable products, but are also used for loose bulk products. This includes, for example, fuels for fueling machines, chemicals, waste products, dusts, but also food products, cosmetics and pharmaceutical products. IBCs contain a volume of up to 3,000 litres.

### Exemptions in combination with the type of transport, sub-section 1.1.3.1 c) ADR – Craftsman regulation –

If all exemption prerequisites according to 1.1.3.1 c) ADR are observed, complete exemption is granted in terms of hazardous-goods regulations. In other words, the hazardous-goods regulations are no longer applicable.

This lifts a great burden from agricultural, forestry, landscaping and crafts operations, because they no longer have to use the provisions otherwise applicable to the transport of hazardous goods.

These are:

- use of design-tested packaging
- non-observance of identification and tagging regulations
- exemption from the obligation to carry fire-extinguishing equipment
- exemption from the obligation to carry accompanying documentation (here: carriage document)

In practical terms, this arrangement represents a significant easement, because deliveries for direct consumption up to max. 450 litres are exempted from the ADR regulations as per RSEB 1-4.1 (German Implementation Guideline for Regulation Concerning the Transport of Dangerous Goods by Road and Rail). Transport for direct consumption means that up to 450 L can be driven to the machine, even in a car. This quantity must not be left there, but must be immediately filled into the consumers' tanks and consumed.

Please also observe our **checklist "Craftsman regulation"**, page 33.

### Test or examination

From the viewpoint of hazardous-goods regulations, the mobile diesel filling stations are Intermediate Bulk Containers (IBC). The manufacturer uses different names for these diesel tank systems in some cases, e.g. container or tank. However, these terms, which are known from hazardous-goods legislation, do not have anything to do with the actually applicable packaging definition under hazardous-goods legislation, i.e. Intermediate Bulk Containers / IBC.

Unfortunately, tests and examinations are often not performed on the employed mobile tank systems by an inspection body certified by the German Federal Institute for Materials Testing (BAM) for Intermediate Bulk Containers (IBC).

**Tests and examinations** of this kind are specified by regulations and laws such as the ADR (Accord européen relatif au transport international des marchandises dangereuses par route), the GGVSEB and the GGBefG (Regulations for the Transport of Dangerous Goods). The test or examination intervals are between 2½ and 5 years – from the date of manufacture.

### Check the type plate of your mobile diesel tank system.

**If the last stamped test/examination was longer than 2½ years ago, you should have a test/examination performed by an authorised inspection body as soon as possible.**



Example:  
DT-Mobil EASY 200 L



## – CHECKLIST –

### TRANSPORT OF DIESEL FUEL ACCORDING TO THE CRAFTSMAN REGULATION

Claim to the craftsman regulation [1.1.3.1 c) ADR]	yes	no *
Are the deliveries in question associated with the primary business activity?		
Quantities not exceeding 450 litres per package		
Do not exceed max. quantities according to the table 1.1.3.6 ADR – 1000-point rule – (diesel fuel = 1000 litres net)		
Measures taken to prevent leakage of the contents under normal transport conditions		
Load adequately secured		
Leak-proof and undamaged containment and closures of the packagings		
No adhesion of dangerous residues		
No transport for internal or external supply of the business. Exception: transport for direct consumption according to RSEB 1-5.1		
* Exemption cannot be claimed		
Additional regulations to be observed:		
Instruction given		



Example: DT-Mobil EASY for direct consumption



# CEMO diesel trolley

Mobile fuelling on site used to be a tricky topic. Apart from the question of transport, smaller quantities of fuel were easily spilled, depending on whether tank connections, funnels or hoses were used. The new CEMO tank trolleys are a completely different story. They deliver up to 100 litres of diesel fuel or petrol on site in absolute safety and in accordance with regulations.

Diesel



CAS battery

Totally mobile and cable free, independent of vehicle batteries.



integrated vent

The integrated vent system means that fuel can be taken out continuously without the trolley needing to be opened.



anti-kink protection + swivel joint + shut-off valve

The anti-kink protection and swivel joint provide the best possible protection for your delivery hose. The container can be completely closed with an isolation valve for transport.

**NEW**



nozzle holder

Integrated dispensing nozzle holder with lock.



recesses for lashing straps

Integrated guides for ratchet straps (100 L) provide safety for transport in the vehicle.

hose holder

Whether upright or horizontal – everything fits; no hose out of place.



all-terrain wheels

Large tyres for easy handling on terrain and over stairs.



# CEMO diesel trolley PG 4



**CENTRI SP30  
EXTREMELY  
QUIET**

Diesel

## Diesel trolley 60 L and 100 L

- suitable for use under ADR 1.1.3.1 c) for single-site refuelling by a person in the course of their primary business
- polyethylene container with integral hand grip and carry handles
- filler cap with integral vent and breather valve
- outlet connection with isolation valve
- trolley 100 L: 300mm diameter pneumatic tyres, all-terrain
- trolley 60 L: 240mm diameter plastic tyres
- internal baffle
- integral nozzle holder
- trolley 100 L: moulded recesses enabling strapping during transport

### Mounted pump:

- crank pump 0,38 L per revolution with 3m delivery hose DN 19 and nozzle
- self-priming pump CENTRI SP30, 12V, 30 L/min, extremely quiet, with 3m dispensing hose DN 19 and 4m fly leads or CAS battery



Diesel trolley 60 L with 12 V pump CENTRI SP30



Diesel trolley 100 L with 18 V pump CENTRI SP30 and CAS battery

Accessory: digital flow meter K24 for assembly between dispensing hose and automatic nozzle for the version with electric pump, see page 121.



Diesel trolley 60 L with crank pump

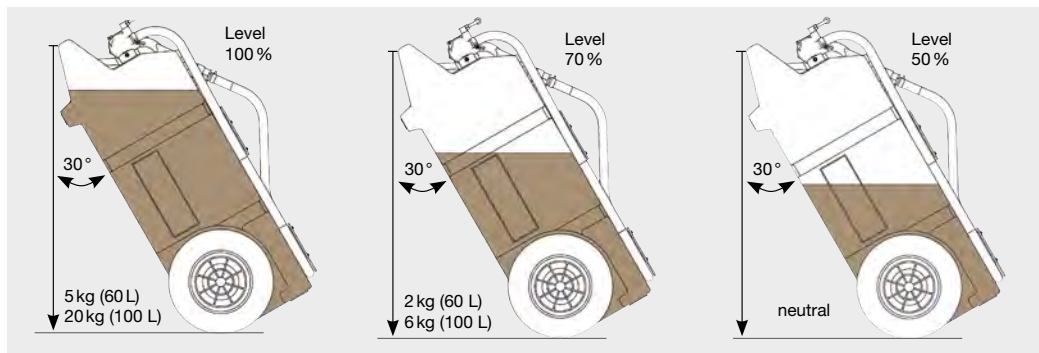

Weight distribution at handle while moving 60 L and 100 L trolley

## CEMO diesel trolley

### Description/Capacity

Description/Capacity	Dimensions in cm (l x w x h)	Weight approx. kg	Order no.
60L, with crank pump and manual nozzle	90 x 53 x 38	15	11100
60L, with submersible pump 12 V CENTRI SP30 and automatic nozzle	90 x 53 x 38	15	11133
100L, with crank pump and manual nozzle	100 x 59 x 43	20	11101
100L, with submersible pump 12 V CENTRI SP 30 and automatic nozzle	100 x 59 x 43	20	11102

Description	Dispensing volume pump	Capacity of battery	Max. volume (litre) per battery charge	Dimensions in cm (l x w x h)	Order no.
charger and battery included					
diesel trolley 60 L <b>NEW</b>	30 L/min	2 Ah	360	90 x 53 x 38	11597
diesel trolley 100 L <b>NEW</b>	30 L/min	4 Ah	720	100 x 59 x 43	11598
Supplied without charger or battery – use your own CAS battery					
diesel trolley 60 L <b>NEW</b>	30 L/min	-	-	90 x 53 x 38	11590
diesel trolley 100 L <b>NEW</b>	30 L/min	-	-	100 x 59 x 43	11591

Accessory see page 44

# CEMO DT MOBIL EASY

Innovative diesel filling stations offering a wealth of useful features.

Diesel



adjustable lid mount

The adjustable lid mount allows it to be installed either on the left or the right for the best possible access (460 L and 600 L).

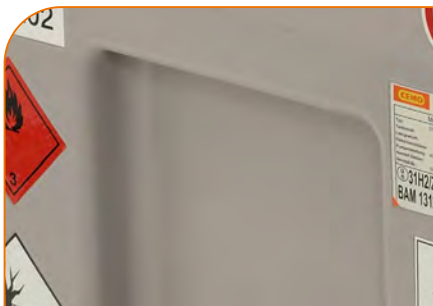

built-in ergonomic carry handles

The built-in carry handles enable the equipment to be handled easily during loading.

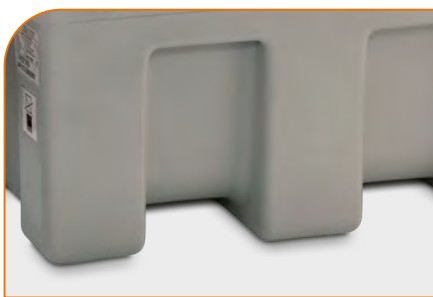

integral forklift pockets

The integral forklift pockets make handling easier when the tank is full.



built-in hose brackets

The built-in hose brackets keep things tidy until you next need to fill up.



dispensing hose can be isolated

The isolation valve enables the container to be sealed off completely, thus adding to safety during transportation (125 L, 200 L, 460 L, 600 L, 850/100 L and 980 L).



Video  
DT-Mobil EASY



recesses for ratchet tie-down

Integral recesses (125 L, 200 L 210 L and 440 L) and lashing eyes (460 L, 600 L, 850 L/100 L and 980 L) to allow immobilisation with a ratchet lashing strap during transportation.



folding crane eye and lashing eyes

The folding crane and lashing eyes (460 L, 600 L, 850 L/100 L and 980 L) make it easier to secure the load in the prescribed manner, and serve at the same time as fastening eyes if the device is lifted by crane.

# CEMO DT MOBIL EASY 125 L and 210 L PG 4 ACCORDING TO ADR 1.1.3.1 C)

## DT-Mobil EASY

Certified for transport for immediate consumption according to ADR1.1.3.1 c)

### Container:

- single-walled 125 L, 210 L, 440 L and 440/50 L polyethylene
- integral dispensing nozzle holder
- integral filler neck
- integrated vent with pressure relief
- integral forklift pockets and handles
- integral recesses for ratchet straps during transport

### Pre-fitted pump:

- self-priming pump 24 V DC, 40 L/min, with automatic nozzle, 4 m dispensing hose DN 19 and 4 m electric cable
- submersible pump CENTRI SP30, 12 V, 30 L/min, extremely quiet, with automatic nozzle, 4 m dispensing hose DN 19 and 4 m electric cable or CAS battery
- hand pump 25 L/min, 2.7 m dispensing hose DN 19 and manual nozzle



210 L with pump 12 V



**CENTRI SP30**  
**EXTREMELY QUIET**



210 L with 12V submersible CENTRI SP30 12 V and hinged lid

Diesel



210 L with pump 12 V



125 L with hand pump

## TOP SELLER

### DT-Mobil Easy 210 litre with CENTRI SP30 pump

#### Packages:

- without hinged lid: order no. 10978
- with hinged lid: order no. 10981



210 L with CENTRI SP30 12 V and CAS battery



210 L with CENTRI SP30 18 V and CAS battery

**NEW**

**CAS** COMPLETE ALLIANCE SYSTEM

## DT-MOBIL EASY ACCORDING TO ADR 1.1.3.1 C)

Description	Capacity L	Dimensions in cm (l x w x h)	Weight approx. kg	Order no.
Hand pump and manual nozzle	125	80 x 60 x 45	22	8915
Pump CENTRI SP30, 12 V, 30 L/min, automatic nozzle	125	80 x 60 x 45	20	10606
Pump CENTRI SP30, 12 V, 30 L/min, automatic nozzle	210	78.5 x 59.5 x 68.5	19	10978
Pump 12 V, 40 L/min, automatic nozzle	210	78.5 x 59.5 x 68.5	22	10980
Pump CENTRI SP30, 12V, 30 L/min, automatic nozzle, hinged lid	210	78.5 x 59.5 x 68.5	21	10981
Pump 12 V, 40 L/min, automatic nozzle, hinged lid	210	78.5 x 59.5 x 68.5	23	10983
Pump 24 V, 40 L/min, automatic nozzle, hinged lid	210	78.5 x 59.5 x 68.5	23	11104

Description	Dispensing volume pump	Capacity of battery	Max. volume (litre) per battery charge	Dimensions in cm (l x w x h)	Order no.
charger and battery included					
DT-Mobil EASY 210 L with hinged lid <b>NEW</b>	30 L/min	4 Ah	720	78.5 x 59.5 x 68.5	11601
Supplied without charger or battery – use your own CAS battery					
DT-Mobil EASY 210 L with hinged lid <b>NEW</b>	30 L/min	-	-	78.5 x 59.5 x 68.5	11594

Accessories: see page 44



# CEMO DT MOBIL EASY pick-up 210 L PG 4

Diesel

## The perfect solution for transport by pick-up truck.

- overall height 45 cm. Fits under the load area cover.
- with recess for tie-down straps to secure tank in load area

### DT-Mobil EASY

certified for transport or for immediate consumption under ADR 1.1.3.1 c).

#### Container:

- Pick-up 210 L, polyethylene, single wall
- integral nozzle holder
- integral filler neck
- filler cap with vent and breather valves
- integral forklift pockets and handles
- integral recesses for fastening with tie-down straps during transport

#### Pre-installed pump:

- self-priming pump 12 V DC, 40 L/min, with auto shut-off nozzle, 4 m dispensing hose DN 19 and 4 m electrical cable
- submersible pump CENTRI SP 30, 30 L/min, extremely quiet, with 4 m dispensing hose DN 19 and 4 m cable or CAS battery



**CENTRI SP 30**  
**EXTREMELY QUIET**

210 L with submersible pump CENTRI SP 30 and hinged lid



Pick-up 210 L with submersible pump CENTRI SP 30 12 V



Pick-up 210 L with pump 12 V

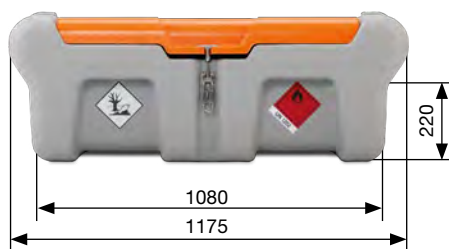

Pick-up 210 L with submersible pump CENTRI SP 30 18 V and CAS battery



Integral recesses for fastening with tie-down straps

## DT-MOBIL EASY PICK-UP 210 L ACCORDING TO ADR 1.1.3.1 c)

Description / Capacity	Dimensions in cm (l x w x h)	Weight approx. kg	Order no.
DT-Mobil EASY pick-up 210 L with submersible pump CENTRI SP 30, 12 V, 30 L/min, and auto shut-off nozzle	118 x 79 x 45	26	11248
DT-Mobil EASY pick-up 210 L with 12V pump, 40 L/min, and auto shut-off nozzle	118 x 79 x 45	29	11249
DT-Mobil EASY pick-up 210 L with submersible pump CENTRI SP 30, 12 V, 30 L/min, auto shut-off nozzle and lid	118 x 79 x 45	30	11250
DT-Mobil EASY pick-up 210 L with pump 12 V, 40 L/min, auto shut-off nozzle and lid	118 x 79 x 45	34	11251
DT-Mobil EASY pick-up 210 L with pump 24 V, 40 L/min, auto shut-off nozzle and lid	118 x 79 x 45	34	11252

Description	Dispensing volume pump	Capacity of battery	Max. volume (litre) per battery charge	Dimensions in cm (l x w x h)	Order no.
DT-Mobil EASY Pick-up 210 L with hinged lid <b>NEW</b>	30 L/min	4 Ah	720	118 x 79 x 45	11627
Supplied without charger or battery – use your own CAS battery					
DT-Mobil EASY Pick-up 210 L with hinged lid <b>NEW</b>	30 L/min	-	-	118 x 79 x 45	11626

Accessories: see page 44

# CEMO DT MOBIL EASY 440 L

# CEMO DT MOBIL EASY COMBI 440/50 L PG 4

ACCORDING TO ADR 1.1.3.1 C)

### DT-Mobil EASY

- container: 440 L and 440/50 L
- Description see page 38

### COMBI versions with additional tank for AdBlue®:

with submersible pump CENTRI SP30, 4 m dispensing hose DN 19 and automatic nozzle



Diesel/AdBlue®



440 L Premium with automatic nozzle and meter



440/50 L COMBI with pump 12 V



440 L with quick coupling



440 L with pump 12 V

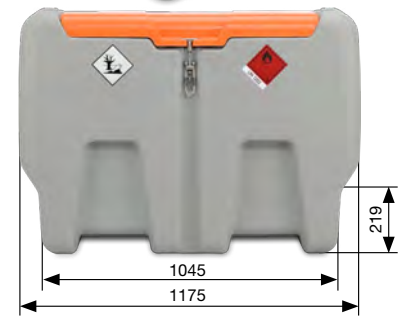

440 L and 440/50 L

### DT-MOBIL EASY ACCORDING TO ADR 1.1.3.1 c)

Description	Capacity L	Dimensions in cm (l x w x h)	Weight approx. kg	Order no.
Quick coupling and hinged lid	440	118 x 80 x 71	35	11110
Submersible pump CENTRI SP30 SP30, 12 V, 30 L/min, extremely quiet, automatic nozzle	440	118 x 80 x 71	33	10984
Pump 12 V, 40 L/min, automatic nozzle	440	118 x 80 x 71	35	10985
Submersible pump CENTRI SP30, 12 V, 30 L/min, extremely quiet, automatic nozzle, hinged lid	440	118 x 80 x 71	36	10987
Pump 12 V, 40 L/min, automatic nozzle, hinged lid	440	118 x 80 x 71	39	10988
Pump 24 V, 40 L/min, automatic nozzle, hinged lid	440	118 x 80 x 71	39	11105
Premium, pump 12 V, 40 L/min, meter K24, hose reel with 8 m hose DN 19, automatic nozzle, hinged lid	440	118 x 80 x 85	62	11107
Premium, pump 24 V, 40 L/min, meter K24, hose reel with 8 m hose DN 19, automatic nozzle, hinged lid	440	118 x 80 x 85	62	11108

Description	Dispensing volume pump	Capacity of battery	Max. volume (L) per battery charge	Dimensions in cm (l x w x h)	Order no.
<b>charger and battery included</b>					
DT-Mobil EASY 440 L with CENTRI SP30, 18V, with hinged lid	<b>NEW</b> 30 L/min	4 Ah	720	118 x 80 x 71	11603
DT-Mobil EASY 440 L with Cematic 3000/18V, with hinged lid	<b>NEW</b> 40 L/min	4 Ah	900	118 x 80 x 71	11687
<b>Supplied without charger or battery – use your own CAS battery</b>					
DT-Mobil EASY 440 L with CENTRI SP30, 18V, with hinged lid	<b>NEW</b> 30 L/min	-	-	118 x 80 x 71	11596
DT-Mobil EASY 440 L with Cematic 3000/18V, with hinged lid	<b>NEW</b> 40 L/min	-	-	118 x 80 x 71	11686

### DT-MOBIL EASY COMBI ACCORDING TO ADR 1.1.3.1 c)

Description	Capacity L	Dimensions in cm (l x w x h)	Weight approx. kg	Order no.
Submersible pump CENTRI SP30, 12 V, 30 L/min, extremely quiet, automatic nozzle, hinged lid	COMBI	118 x 80 x 85	51	10991
Pump 12 V, 40 L/min, automatic nozzle, hinged lid	440/50	118 x 80 x 85	54	10992
Pump 24 V, 40 L/min, automatic nozzle, hinged lid	440/50	118 x 80 x 85	54	11106

**Accessories: see page 44**

# CEMO DT MOBIL EASY 200, 460 and 600 L PG 4

ADR CERTIFIED

Diesel



DT-Mobil EASY 600 L with electric pump, automatic nozzle and hinged lid



DT-Mobil EASY 200 L with electric pump, automatic nozzle and hinged lid



See catalogue page 153 for suitable steel bund SW 600/2

### DT-Mobil EASY with ADR certification

certified for transport under ADR, examination every 2 ½ years according to ADR 6.5.4.4.1 b) and ADR 6.5.4.4.2 b).\*\*\* Completely assembled.

#### Container:

- 200 L, 460 L or 600 L polyethylene, single-walled
- with hinged lid (200 L version)
- with crane eyes (460 L and 600 L version)
- integral filler neck
- filler cap with vent and breather valves
- integral forklift pockets and handles
- integral recesses (200 L) or loops (460 L and 600 L) for securing with ratchet straps during transport

#### Pre-fitted pump:

- self-priming, pump 12 V or 24 VDC, 25 or 40 L/min, with automatic nozzle, 4 m dispensing hose DN 19 and 4 m electrical cable
- submersible pump CENTRI SP30, 12 V, 30 L/min, extremely quiet, with automatic nozzle, 4 m dispensing hose DN 19 and 4 m electrical cable
- hand pump 25 L/min, 2.7 m dispensing hose DN 19 and manual nozzle

\*\*\* Transport certification for all plastic IBCs is limited to a life of 5 years. The 200 L model is therefore also certified for transport for direct consumption under ADR 1.1.3.1 c). Please note that transport certification for all plastic IBCs is limited to a period of 5 years.

## DT-MOBIL EASY WITH ADR CERTIFICATION

Description/Capacity	Dimensions in cm (l x w x h)	Weight approx. kg	Order no.
200 L with hand pump, manual nozzle and hinged lid	80 x 62 x 61	26	10080
200 L with submersible pump CENTRI SP30, 12 V, 30 L/min, automatic nozzle and hinged lid	80 x 62 x 61	24	10735
200 L with pump 12 V, 40 L/min, automatic nozzle and hinged lid	80 x 62 x 61	28	10082
200 L with pump 24 V, 40 L/min, automatic nozzle and hinged lid	80 x 62 x 61	28	10112
460 L without pump, with quick coupling for vehicles with integrated suction pump	116 x 80 x 81	42	10415
460 L with pump 12 V, 40 L/min and automatic nozzle	116 x 80 x 81	47	10416
460 L with pump 24 V, 40 L/min and automatic nozzle	116 x 80 x 81	47	10417
460 L with pump 12 V, 40 L/min, automatic nozzle and hinged lid	116 x 80 x 86	60	10418
460 L with pump 24 V, 40 L/min, automatic nozzle and hinged lid	116 x 80 x 86	60	10419
600 L without pump, with quick coupling for vehicles with integrated suction pump	116 x 80 x 102	48	10084
600 L with pump 12 V, 40 L/min and automatic nozzle	116 x 80 x 102	53	10085
600 L with pump 24 V, 40 L/min and automatic nozzle	116 x 80 x 102	53	10086
600 L with pump 12 V, 40 L/min, automatic nozzle and hinged lid	116 x 80 x 107	66	10087
600 L with pump 24 V, 40 L/min, automatic nozzle and hinged lid	116 x 80 x 107	66	10088

Accessories: see page 44



# CEMO DT MOBIL EASY 460 and 600 L PG 4

ADR CERTIFIED AND WITH CAS BATTERY



**NEW**

**DT-Mobil EASY with ADR certification** certified for transport under ADR, examination every 2 ½ years according to ADR 6.5.4.4.1 b) and ADR 6.5.4.4.2 b)..\*\*\*

- Completely assembled
- submersible pump Cematic 3000/18, 18 V, 40 L/min
  - totally mobile and cable-free, independent of vehicle batteries
  - very low self-discharge, no environmentally harmful heavy metals
  - no memory effect

- high intrinsic safety and integrated protection electronics (11689 and 11691)
- charger 220-240 VAC, output 18 V-3A, included
- with hinged lid
- 4 m dispensing hose DN 19

DT MOBIL Easy 460 L with 18V pump Cematic 3000/18 and CAS battery

\*\*\* Please note that transport certification for all plastic IBCs is limited to a period of 5 years.

Description charger and battery included		Dispensing volume pump	Capacity of battery	Max. volume (litre) per battery charge	Dimensions in cm (l x w x h)	Order no.
DT-MOBIL EASY 460 L with Cematic 3000/18	<b>NEW</b>	40 L/min	4 Ah	900	116 x 80 x 86	11689
DT-MOBIL EASY 600 L with Cematic 3000/18	<b>NEW</b>	40 L/min	4 Ah	900	116 x 80 x 107	11691
Supplied without charger or battery – use your own CAS battery						
DT-MOBIL EASY 460 L with Cematic 3000/18	<b>NEW</b>	40 L/min	-	-	116 x 80 x 86	11688
DT-MOBIL EASY 600 L with Cematic 3000/18	<b>NEW</b>	40 L/min	-	-	116 x 80 x 107	11690



**Accessories see page 44**

## Battery Systems, Li-Power-Block PG 4

SUITABLE FOR PUMPS WITH 12 VDC SUPPLY VOLTAGE

- Lithium iron phosphate battery (LiFePO<sub>4</sub>)**
- totally mobile, independent of vehicle batteries
  - 12.8 V nominal voltage, 3.3 Ah or 5.5 Ah capacity
  - battery operating temperature range: -30°C to + 80°C
  - very low self-discharge, no environmentally harmful heavy metals, no memory effect
  - high intrinsic safety and integrated protection circuit, electrical protection class IP 67
  - terminal protection caps protect against accidental short circuit
  - easy to hang or carry due to rope handle
  - includes charger 100 – 240 VAC, output 14.4 V – 3 A



Li-Power-Block with rope loop for easy hanging and carrying

### BATTERY SYSTEMS, LI-POWER-BLOCK

Description	Order no.
Li-Power-Block 12.8 V - 3.3 Ah with charger Discharge volume of approx. 300-380 litres on a single charge, without idling, depending on the pump, charging time approx. 66 min.	10749
Li-Power-Block 12.8 V - 5.5 Ah with charger Sufficient for an output volume of approx. 500 – 630 litres without idling, depending on the pump, charging time approx. 110 min.	10750



# CEMO DT MOBIL EASY 980 L

ADR CERTIFIED

Certified for transport under ADR. Examination every 2 ½ years according to ADR 6.5.4.4.1 b) and ADR 6.5.4.4.2 b).\*\*\* Completely assembled.

**Container:**

- 980 L polyethylene, single-walled
- integral baffle
- integral dispensing nozzle holder
- integral filler neck
- filler cap with vent and breather valves
- integral forklift pockets
- integral handles
- with crane eyes
- with flap lid

- integral loops for securing the trolley with ratchet lashing strap during transport

**Basic versions:**

with powerful electric pump, 4 m dispensing hose DN25 / 6 m with CENTRI SP 80 (without hose reel, meter and filter) and automatic nozzle

**Premium versions:**

with powerful electric pump, hose reel with 8 m hose DN25, flow meter, filter with water separator and automatic nozzle

**Pumpen:**

- Bipump 12 V, 500 W, approx. 85 L/min\*
- pump Cematic Duo 24/12 V, 420 W, approx. 70/35 L/min\*
- pump Cematic 72, 230 V, 500 W, approx. 72 L/min\*
- submersible pump CENTRI SP80 AC, 230 V, 80 L/min\*
- hand pump 60 L/min\*



maintenance-free, high-performance submersible pump CENTRI SP80 AC, 230 V



DT-Mobil EASY 980



DT-Mobil EASY 980 without pump, with quick coupling



DT-Mobil EASY 980 Basic



DT-Mobil EASY 980 with hand pump



DT MOBIL Easy 980 Basic with CENTRI SP80



DT MOBIL Easy 980 Premium with CENTRI SP80

## DT-MOBIL EASY 980 L WITHOUT PUMP OR WITH HAND PUMP

Description	Capacity L	External dimensions cm (l x w x h)	Weight approx. kg	Order no.
980 without pump with quick coupling	980	127 x 107 x 112	95	10817
980 with hand pump 60 L/min, 4 m dispensing hose DN 19, manual nozzle	980	127 x 107 x 112	100	11025

## DT-MOBIL EASY 980 L DIESEL TANK

Description	Capacity L	External dimensions cm (l x w x h)	Weight approx. kg	Electric pump version			
				Bipump 12 V	Cematic Duo 24/12 V	Cematic 230 V	CENTRI SP80 230 V
				Order no.	Order no.	Order no.	Order no.
980 Basic	980	127 x 107 x 112	107	10818	10822	10826	<b>NEW</b> 11647
980 Premium	980	127 x 107 x 112	130	10819	10823	10827	<b>NEW</b> 11648

\* Pump output in free flow. Please note that the pump output can fall sharply depending on the length and cross-sectional area of the hose.

\*\*\* Please note that transport certification for all plastic IBCs is limited to a period of 5 years.

# CEMO DT MOBIL EASY COMBI 850/100 L PG 4

ADR CERTIFIED

Certified for transport under ADR.  
Examination every 2 ½ years according to ADR 6.5.4.4.1 b) and ADR 6.5.4.4.2 b).\*\*\*  
Completely assembled.

**Container:**

- 850/100 L polyethylene, single-walled (diesel/AdBlue® tank)
- integral baffle
- integral dispensing nozzle holder
- integral filler neck
- filler cap with vent and breather valves
- integral forklift pockets
- integral handles
- with crane eyes
- integral loops for securing the trolley with ratchet lashing strap during transport



DT-Mobil Easy COMBI 850/100 Premium

**Basic versions:**

with powerful electric pump, 4 m dispensing hose DN25 (without hose reel, meter and filter) and automatic nozzle

**Premium versions:**

with powerful electric pump, hose reel with 8 m hose DN25, flow meter, filter with water separator and automatic nozzle



DT-Mobil EASY COMBI 850/100 Premium

**Pumps:**

- pompe Bipump 12 V, 500 W, approx. 85 L/min\*
- pompe Cematic Duo 24/12 V, 420 W, approx. 70/35 L/min\*
- pompe Cematic 72, 230 V, 500 W, approx. 72 L/min\*
- submersible pump CENTRI SP30 12 V, 220 W, approx. 25 L/min\*
- hand pump 60 L/min\*

**MBI versions**

**with additional tank for AdBlue®:**

with submersible pump CENTRI SP30, 12 V, 5 m dispensing hose DN 19 and automatic nozzle

## DT-MOBIL EASY COMBI 850/100 L DIESEL-/ADBLUE®-TANK

Description	Capacity L	External dimensions cm (l x w x h)	Weight approx. kg	Electric pump version diesel (AdBlue: CENTRI SP30 12 V)		
				Bipump 12 V Order no.	Cematic Duo 24/12 V Order no.	Cematic 230 V Order no.
850/100 Basic	850/100	127 x 107 x 112	121	10820	10824	10828
850/100 Premium	850/100	127 x 107 x 112	143	10821	10825	10829

\* Pump output in free flow. Please note that the pump output can fall sharply depending on the length and cross-sectional area of the hose.

\*\*\* Please note that transport certification for all plastic IBCs is limited to a period of 5 years.











Diesel/AdBlue®







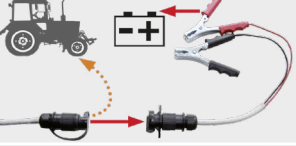

# CEMO DT MOBIL EASY PG 4

## ACCESSORIES

Description	Order no.
 Lid for DT-Mobil EASY 125 L and 200 L (from year of construction 2011)	8963
 Hinged lid lock for DT-Mobil EASY 125 L and 200 L, complete with two keys	10214
 Hinged lid for DT-Mobil EASY 210 L	11062
Hinged lid for DT-Mobil EASY pick-up 210 L, 440 L and 440/50 L	11057
 Hinged lid for DT-Mobil EASY 430 L, 460 L, 600 L, 850/100 L and 980 L (can be hinged on right or left)	8833
 K24 Digital flow meter for 12 V and 24 V pumps, 40 L/min for DT-Mobil EASY 200 L	8832
K24 Digital flow meter for 12 V and 24 V pumps, 40 L/min for DT-Mobil EASY 430 L, 460 L and 600 L	8908
K24 Digital flow meter for DT-Mobil EASY 210 L, 440 L and 440/50 L	11111
K24 Digital flow meter for DT-Mobil EASY 850/100 L and 980 L	10905
 K33 flow meter for DT-Mobil EASY 980 L with hand pump	11171
 Contents gauge for DT-Mobil EASY 220 L	11256
Contents gauge for DT-Mobil EASY 440 L	11058
Contents gauge for DT-Mobil EASY 440 L/50 L	11059
Contents gauge for DT-Mobil EASY 850/100 L and 980 L Contents gauge for DT-Mobil EASY 850/100 L and 980 L (from year of manufacture 2021)	11503
 Contents gauge for DT-Mobil EASY 430 L and 460 L	8881
 Contents gauge for DT-Mobil EASY 600 L	10089
Contents gauge for DT-Mobil EASY 850/100 L and 980 L Contents gauge for DT-Mobil EASY 850/100 L and 980 L (until year of manufacture 2020)	10830
 Oil-resistant anti-slip mat for DT-Mobil EASY 125 L, 200 L and 210 L, oil- and weather-resistant	10166
Oil-resistant anti-slip mat for DT-Mobil EASY 430 L, 440 L, 440/50 L, 460 L and 600 L, oil- and weather-resistant	10167
 DIN 9680 plug, 3-pin, 6 - 24 V, max. 25 A, IP 54	10229
 DIN 9680 socket, 3-pin, 6 - 24 V, max. 25 A, IP 54	10230
 Adhesive label set for retrofitting to DT-Mobil EASY	10261

## ACCESSORY FOR DT-MOBIL EASY WITH CAS BATTERY

 ① charger ASC55, 220 - 240 VAC, 3 A, CAS	<b>NEW</b>	11385
 ② Li-Power battery 18 V / 2,0 Ah CAS	<b>NEW</b>	11386
 ③ Li-Power battery 18 V / 4,0 Ah CAS	<b>NEW</b>	11387
 ④ Li-HD battery 18 V / 8,0 Ah CAS	<b>NEW</b>	11388

# Mobile tank systems for diesel ADR CERTIFIED

## CEMO CUBE MOBIL 980 L PG 4

**Certified for transport under ADR.**

Examination every 2 1/2 years according to ADR 6.5.4.4.1 b) and ADR 6.5.4.4.2 b).\*\*\*

**Certified as storage tank with General Construction Inspection Certification Z-40.21-589**

- compact design, easy to use
- with integral baffle
- with integral bund
- with visual leak indicator
- integral filler neck
- filler cap with vent and breather valves
- contents gauge
- 1" suction line with shut-off valve
- automatic nozzle with dispensing nozzle holder
- with lockable lid
- integral forklift pockets
- integral handles
- fully assembled



bunded tank offers twice the safety

ergonomic and compact

forkliftable

certified for storage and transport



**CUBE Mobil 980 L Premium**

**Basic version**

with high-performance pump, 4 m dispensing hose DN 25 (without hose reel, flow meter and filter) and automatic nozzle

**Premium version**

with high-performance pump, hose reel with 8 m hose DN 25, flow meter, filter with water separator and automatic nozzle



**Version without pump with quick coupling**



**Version with hand pump 60 L/min**

**Pumps**

Bipump pump, 12 V, 500 W, approx. 85 L/min\*

Cematic Duo pump, 24/12 V, 420 W, approx. 70/35 L/min\*

Cematic 72 pump, 230 V, 500 W, approx. 72 L/min\*



**Basic version with Cematic Duo, 24/12 V**



**Premium version with Bipump, 12 V**

**CEMO CUBE MOBIL 980 L WITHOUT PUMP OR WITH HAND PUMP**

Description	Capacity L	Dimensions in cm (l x w x h)	Weight approx. kg	Order no.
980 without pump with quick coupling	980	130 x 112 x 118	102	11677
980 with hand pump 60 L/min, 4 m dispensing hose DN 19, manual nozzle	980	130 x 112 x 118	117	11678

**CEMO CUBE MOBIL 980 L WITH ELECTRIC PUMP**

Description	Capacity L	Dimensions in cm (l x w x h)	Weight approx. kg	Electric pump version		
				Bipump 12 V	Cematic Duo 24/12 V	Cematic 230 V
<b>980 Basic</b>	980	130 x 112 x 118	123	Order no. 11632	Order no. 11634	Order no. 11636
<b>980 Premium</b>	980	130 x 112 x 118	145	Order no. 11633	Order no. 11635	Order no. 11637

\* Pump output in free flow. Please note that the pump output can fall sharply depending on the length and cross-sectional area of the hose.

\*\*\* Please note that transport certification for all plastic IBCs is limited to a period of 5 years.



# Oil drip mat PG 4

Diesel



**The mobile filling area for filling at construction sites**

- innovative absorption system
- for indoor or outdoor use
- absorbs oil but repels water
- extremely high absorption capacity
- also usable in rainy conditions

A clean solution: the innovative oil drip mat. Available in 3 sizes



Description	Maximum absorption capacity in L	Dimensions (l x w) cm	Weight (approx.) in kg	Order no.
Oil drip mat M10	10	90 x 69	2	11638
Oil drip mat XL30	30	137 x 137	5	11639
Oil drip mat XXL40	44	218 x 137	8.5	11640

Where diesel and AdBlue® are required in mobile situations, tanks need to be filled quickly and without fuss.

CEMO has the solution for you: combined systems that contain both tanks. Which means you only have to bring one tank to the place of use, but have access to diesel and AdBlue® at the same time.

Watch our film on YouTube and be convinced by the innovative professional solution of the CEMO-Tanks.



**YouTube**  
CEMO video:  
The COMBI-Tanks





# CEMO DT MOBIL PRO PE 440 L

## CEMO DT MOBIL PRO PE COMBI 440/50 L PG 4

ACCORDING TO ADR 1.1.3.1 )

### DT-Mobil PRO PE and PRO PE COMBI

- outer bund made from 3 mm painted steel sheet, with lifting lugs, stackable, lockable
- with inner tank for diesel made from polyethylene
- with electronic overfill sensor

#### Basic version:

- powerful pump 12 V or 24 V, self-priming, 40 L/min
- 4 m dispensing hose DN 19
- automatic nozzle

#### Premium version:

- powerful 12 V or 24 V pumps, self-priming, 40 L/min
- hose reel with 8 m hose DN 19
- K24 flow meter
- automatic nozzle

#### COMBI version with additional tank for AdBlue®:

with submersible pump CENTRI SP30, 12 V, 4 m dispensing hose DN 19 and automatic nozzle



440/50 L COMBI Basic with pump 12 V



440/50 L COMBI Basic with pump 12 V



440 L without pump, with quick coupling



440 L Basic with 12 V pump



440 L Premium with 12 V pump

### DT-MOBIL PRO PE 440 L AND PRO PE COMBI 440/50 L

Description	Capacity L	External dimensions cm (l x w x h)	Weight approx. kg	Order no.
PRO PE 440 L without pump, with quick coupling	440	125 x 87 x 107	196	11113
PRO PE 440 L Basic with 12 V pump	440	125 x 87 x 107	202	11115
PRO PE 440 L Basic with 24 V pump	440	125 x 87 x 107	203	11116
PRO PE 440 L Premium with 12 V pump	440	125 x 87 x 107	215	11117
PRO PE 440 L Premium with 24 V pump	440	125 x 87 x 107	216	11118
PRO PE COMBI 440/50 L Basic with 12 V pump	440/50	125 x 87 x 107	208	11119
PRO PE COMBI 440/50 L Basic with 24 V pump	440/50	125 x 87 x 107	209	11120

### ACCESSORY

Description	Order no.
K24 flow meter for diesel	11111



# Mobile COMBI tank systems for diesel and AdBlue®

Contractors want complete, time-saving and simple solutions for the combined filling of diesel and AdBlue® on site. Container handling should also be as simple and time-saving as possible. The combination canister (petrol and oil) for petrol-driven saws is an example. CEMO has now rigorously implemented the wishes of professionals with the DT-MobilCUBE COMBI.

- with ADR transport certification
- 980 L capacity, therefore below the exemption limit of 1,000 L according to ADR 1.1.3.6.3
- also ideally suited for biodiesel and diesel with increased biodiesel content
- versions with powerful 12 V, 24 V and 230 V pumps
- inner container with integrated equipment such as powerful pumps, hose reel (with hose DN 25), meter and filter with water separator, dispensing nozzle holder, optional marquee heaters and power generators.
- DT-MobilCUBE COMBI with second inner tank in polyethylene, for AdBlue®, with CENTRI SP30 electric pump
- bund volume of 110 %
- certified for use in water conservation areas
- The steel tanks are primed and painted. We provide a 5-year warranty against rusting through.



optional lifting frame

for crane hooks or grabs  
Order no. 11112

### optimal use of space

Cubic shape, hence optimal use of space.



high-quality coating

Outer container in painted 3 mm steel sheet\*\* – high-quality coating.



very robust

Inner container in painted 3 mm steel sheet, alternatively in polyethylene, with integrated baffle.



transport-friendly

Galvanised forklift pockets and stacking corners with crane eyes simplify transport and setup. Two tanks can be stacked one on top of the other when full.



\* National installation laws and conditions must be observed. We will be happy to advise you.

\*\* Outer container made of 2.5 mm sheet steel on DT MOBIL PRO ST 980 Basic.

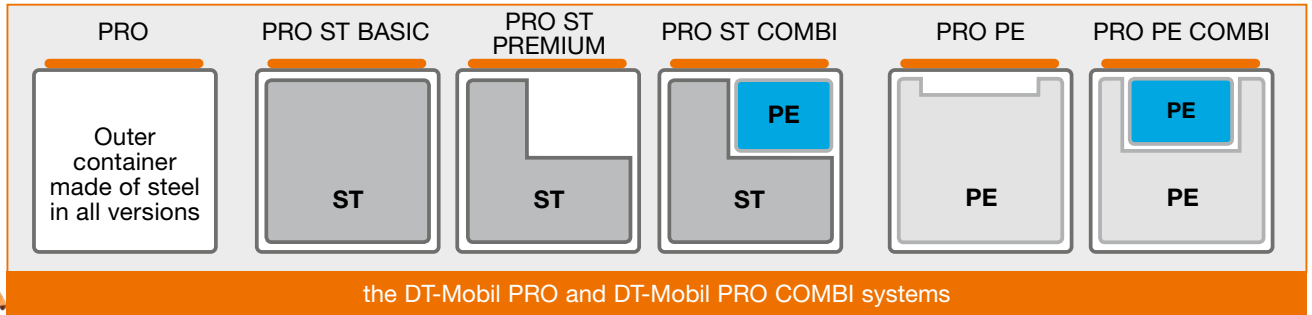

lockable

Lid has integrated bar lock to prevent theft.  
Lid can be locked with a padlock on DT MOBIL PRO ST 980 Basic.



hose grommet

For routing hoses and cables.



easy to open

Gas struts simplify opening and closing of the lid.



tidies away nice and small

All fittings are on the inside and thus protected.  
Inner container with equipment, patent protected.



DT-Mobil PRO ST COMBI 980/200 Premium Plus, with pump Bipump

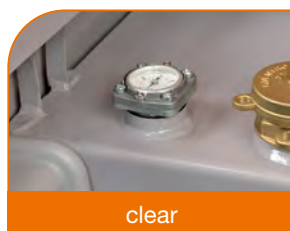

clear

contents gauge



double safety

bund alarm



# CEMO DT MOBIL PRO PE PG 4

ADR CERTIFIED

## DT-Mobil PRO PE

- with inner tank for diesel made from polyethylene\*\*\*\*

### Basic version:

- powerful electric pump
- 4 m dispensing hose DN25 (without hose reel, meter and filter)
- automatic nozzle

### Premium version:

- powerful electric pump
- hose reel with 8 m hose DN25
- K33 flow meter
- cartridge filter with water separator
- automatic nozzle

### Pump options:

- Bipump 12 V, 500 W, approx. 85 L/min\*\*\*
- pump Cematic Duo 24/12 V, 420 W, approx. 70/35 L/min\*\*\*
- pump Cematic 72, 230 V, 500 W, approx. 72 L/min\*\*\*
- hand pump 60 L/min\*\*\*



DT-Mobil PRO PE 980 Basic, with pump Cematic Duo



DT-Mobil PRO PE 980 Premium, with pump Cematic Duo



DT-Mobil PRO PE 980 with hand pump 60 L/min

Examination every 2 ½ years (see ADR 6.5.4.4.1 b and ADR 6.5.4.4.2 b).

## DT-Mobil PRO PE Basic package

- capacity 980 litre
- with inner tank for diesel made from polyethylene\*\*\*\*
- 4 m dispensing hose DN25 (without hose reel, meter and filter)
- automatic nozzle
- 12 V Bipump, 500 W, approx. 85 L/min\*\*\*

Order no. 10787



TOP SELLER



## DT-MOBIL PRO PE DIESEL TANK WITHOUT PUMP OR WITH HAND PUMP

Description	Capacity L	External dimensions cm (l x w x h)	Weight approx. kg	Order no.
PRO PE 980 without pump, with quick coupling	980	136 x 115 x 130	330	10937
PRO PE 980 with hand pump 60 L/min, 4 m dispensing hose DN 19, manual nozzle	980	136 x 115 x 130	335	11026

## DT-MOBIL PRO PE DIESEL TANK WITH ELECTRIC PUMPS

Description	Capacity L	External dimensions cm (l x w x h)	Weight approx. kg	Electric pump version diesel		
				Bipump 12 V	Cematic Duo 24/12 V	Cematic 72, 230 V
				Order no.	Order no.	Order no.
PRO PE 980 Basic	980	136 x 115 x 130	365	10787	10797	10807
PRO PE 980 Premium	980	136 x 115 x 130	385	10789	10799	10809

For accessories see page 51, for tank replacement service, page 54.  
Lifting frame accessory see page 48.

\*\*\* Pump output in free flow. Please note that the pump output can fall sharply depending on the length and cross-sectional area of the hose.

\*\*\*\* Please note that transport certification for all combination IBCs with plastic inner tanks for diesel is limited to a period of 5 years. After that, the inner tank must be replaced. We offer you this tank replacement service.

# CEMO DT MOBIL PRO PE COMBI PG 4

ADR CERTIFIED

## DT-Mobil PRO PE COMBI

- with inner tank for diesel made from polyethylene\*\*\*
- supply cable for both pumps **NEW**

### Basic version:

see DT-Mobil PRO PE

### Premium version:

see DT-Mobil PRO PE

Exception:

K24 meter on version DT-Mobil PRO PE COMBI 850/100 Premium

### Additional tank for AdBlue®:

- made from polyethylene
- pump CENTRI SP30, 12 V
- 5 m dispensing hose DN 19
- automatic nozzle

### Pump options:

- Bipump 12 V, 500 W, approx. 85 L/min\*\*\*
- pump Cematic Duo 24/12 V, 420 W, approx. 70/35 L/min\*\*\*
- pump Cematic 72, 230 V, 500 W, approx. 72 L/min\*\*\*
- submersible pump CENTRI SP30, 12 V, 220 W, approx. 25 L/min\*\*\*



DT-Mobil PRO PE COMBI 850/100 Premium, with pump Cematic Duo



DT-Mobil PRO PE COMBI 850/100 Basic, with pump Cematic Duo

Examination every 2 ½ years (see ADR 6.5.4.4.1 b and ADR 6.5.4.4.2 b).

Diesel/AdBlue®



## DT-Mobil PRO PE COMBI Basic package

- capacity 850/100 litre
- with inner tank for diesel made from polyethylene\*\*\*\*
- 4 m dispensing hose DN25 (without hose reel, meter, filter)
- automatic nozzle
- 12 V Bipump, 500 W, approx. 85 L/min\*\*\*
- additional tank for AdBlue®, details below

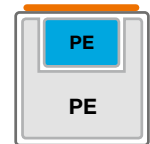

Order no. 10792

**TOP SELLER**

## DT-MOBIL PRO PE COMBI DIESEL & ADBLUE®-TANK WITH ELECTRIC PUMP

Description	Capacity L	External dimensions cm (l x w x h)	Weight approx. kg	Electric pump version diesel (AdBlue: CENTRI SP30 12 V)		
				Bipump 12 V	Cematic Duo 24/12 V	Cematic 72, 230 V
				Order no.	Order no.	Order no.
PRO PE COMBI 850/100 Basic	850/100	136 x 115 x 130	360	10792	10802	10812
PRO PE COMBI 850/100 Premium	850/100	136 x 115 x 130	380	10794	10804	10814

## ACCESSORIES SUITABLE FOR DT-MOBIL PRO PE AND DT-MOBIL PRO PE COMBI

Description	Order no.
K24 meter for DT-Mobil PRO PE and PRO PE COMBI for diesel	10905
Adhesive label set for retrofitting (see page 57)	10261

Tank replacement service see page 54.

\*\*\* Pump output in free flow. Please note that the pump output can fall sharply depending on the length and cross-sectional area of the hose.

\*\*\*\* Please note that transport certification for all combination IBCs with plastic inner tanks for diesel is limited to a period of 5 years. After that, the inner tank must be replaced. We offer you this tank replacement service.

# CEMO DT MOBIL PRO ST PG 4

ADR CERTIFIED

## DT-Mobil PRO ST

- with inner tank for diesel made from painted 3 mm steel sheet
- ADR certification for unlimited time period
- **NEW** with overflow prevention sensor

### Basic version:

- powerful electric pump
- 4 m dispensing hose DN25/1 (without hose reel, meter and Filter)
- automatic nozzle

### Premium version:

- powerful electric pump
- hose reel with 8 m hose DN25
- K33 flow meter
- cartridge filter with water separator
- automatic nozzle

### Premium Plus version:

- powerful electric pump
- hose reel with 8 m hose DN25
- meter with access control and tank data management system "CMO 10" for up to 250 users, incl. 5 user keys and 1 master key
- cartridge filter with water separator
- automatic nozzle

### Premium Plus SIM version:

same as Premium Plus, in addition:

- modem for data transfer
- GPS function
- electronic contents display

Tanks must be examined every 2 ½ years (see ADR 6.5.4.4.1 b and ADR 6.5.4.4.2 b).



DT-Mobil PRO ST 980 Premium, with pump Cematic 72

PRO ST Premium

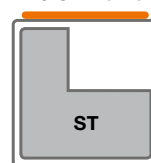

PRO ST Basic



### Pump options:

- Bipump 12 V, 500 W, approx. 85 L/min\*\*\*
- pump Cematic Duo 24/12 V, 420 W, approx. 70/35 L/min\*\*\*
- pump Cematic 72, 230 V, 500 W, approx. 72 L/min\*\*\*
- hand pump 60 L/min\*\*\*



DT-Mobil PRO ST 980 Basic, with Cematic 72 pump



DT-Mobil PRO ST 980 Basic, with hand pump 60 L/min



Optional: electronic overflow prevention sensor

Information on Premium Plus and Plus SIM see page 54

## DT-MOBIL PRO ST DIESEL TANK WITHOUT PUMP OR WITH HAND PUMP

Description	Capacity L	External dimensions cm (l x w x h)	Weight approx. kg	Order no.
DT-Mobil PRO ST 980 Basic without pump, with quick coupling	980	136 x 115 x 118	430	11425
DT-Mobil PRO ST 980 Basic with hand pump 60 L/min, 4 m dispensing hose DN 19, manual nozzle	980	136 x 115 x 118	440	11426

## DT-MOBIL PRO ST DIESEL TANK WITH ELECTRIC PUMPS

Description	Capacity L	External dimensions cm (l x w x h)	Weight approx. kg	Electric pump version diesel		
				Bipump 12 V	Cematic Duo 24/12 V	Cematic 72, 230 V
				Order no.	Order no.	Order no.
PRO ST 980 Basic	980	136 x 115 x 118	450	11427	11428	11429
PRO ST 980 Premium	980	136 x 115 x 130	525	10790	10800	10810
PRO ST 980 Premium Plus	980	136 x 115 x 130	525	11121	11122	11123
PRO ST 980 Premium Plus SIM	980	136 x 115 x 130	525	10791	10801	10811

## ACCESSORIES SUITABLE FOR DT-MOBIL PRO ST WITHOUT PUMP OR WITH HAND PUMP

Description	Order no.
Generator and heater connection set with quick couplings (1/2" flow and return braided hoses)	11506
K33 flow meter for DT MOBIL PRO ST with hand pump	11171
K33 flow meter for DT MOBIL PRO ST Basic	11423
Filter with water separator for DT-Mobil PRO ST Basic	11424

\*\*\* Pump output in free flow. Please note that the pump output can fall sharply depending on the length and cross-sectional area of the hose.

Accessories for DT-Mobil PRO ST and PRO ST Combi with electric pump see page 53. Accessory lifting frame see page 48.



# CEMO DT MOBIL PRO ST COMBI PG 4

ADR CERTIFIED

## DT-Mobil PRO ST COMBI

- with inner tank for diesel made from painted 3 mm steel sheet
- Certification for unlimited period of time
- with overflow prevention sensor
- **NEW** supply cable for both pumps

### Basic version:

see DT-Mobil PRO ST

### Premium version:

see DT-Mobil PRO ST

### Premium Plus version:

see DT-Mobil PRO ST

### Premium Plus SIM version:

see DT-Mobil PRO ST

### Additional tank for AdBlue®:

- made from polyethylene
- pump CENTRI SP30, 12 V or pump Cematic Blue 230 V
- 5 m dispensing hose DN 19
- automatic nozzle



DT-MOBIL PRO ST COMBI 980/200 Premium, with Bipump

## Pump options:

- Bipump 12 V, 500 W, approx. 85 L/min\*\*\*
- pump Cematic Duo 24/12 V, 420 W, approx. 70/35 L/min\*\*\*
- pump Cematic 72, 230 V, 500 W, approx. 72 L/min\*\*\*
- submersible pump CENTRI SP30, 12 V, 220 W, approx. 25 L/min\*\*\* (for the 24 V and 230 V versions with voltage transformer)



DT-Mobil PRO ST COMBI 980/200 Premium Plus, with Bipump

Examination every 2 ½ years (see ADR 6.5.4.4.1 b and ADR 6.5.4.4.2 b).

## PRO ST COMBI

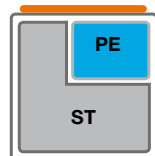

Overflow prevention sensor



Accessory: Generator and heater connection set complete with flow and return braided hoses and two sets of quick coupling 1/2" ET



## DT-MOBIL PRO ST COMBI DIESEL & ADBLUE®-TANK WITH ELECTRIC PUMPS

Description	Capacity L	External dimensions cm (l x w x h)	Weight approx. kg	Electric pump version diesel (AdBlue: CENTRI SP30)		
				Diesel: Bipump 12 V	Cematic Duo 24/12 V	Cematic 72, 230 V
				Order no.	Order no.	Order no.
PRO ST COMBI 980/200 Basic	980/200	136 x 115 x 130	510	10793	10803	11327
PRO ST COMBI 980/200 Premium	980/200	136 x 115 x 130	535	10795	10805	11328
PRO ST COMBI 980/200 Premium Plus	980/200	136 x 115 x 130	535	11124	11125	11329
PRO ST COMBI 980/200 Premium Plus SIM	980/200	136 x 115 x 130	535	10796	10806	11330

## ACCESSORIES SUITABLE FOR DT-MOBIL PRO ST AND DT-MOBIL PRO ST COMBI WITH ELECTRIC PUMP

Description	Order no.
K33 flow meter for DT-Mobil PRO ST COMBI with electric pump	10906
Adhesive label set for retrofitting (see page 61)	10261
Generator and heater connection set with quick couplings (1/2" flow and return braided hoses)	11506

\*\*\* Pump output in free flow. Please note that the pump output can fall sharply depending on the length and cross-sectional area of the hose.

Lifting frame accessory see page 48.



# CEMO tank replacement service and Complete Care Package for DT MOBIL PRO PE and COMBI PG 100

ADR certification is limited to 5 years for all combination IBCs, such as our DT-Mobil PRO PE and PRO PE COMBI.

Thereafter, the inner tank for diesel must be renewed. We offer this tank replacement service including ADR test certificate. This offers you the following advantages:

- The inspection by an officially recognized expert that is required after 5 years as per ADR 6.5.4.4.1 a) for all metal IBCs, all rigid plastic IBCs and all combination IBCs (cost approx. € 260) is included in the tank replacement service.
- Experts inspect the complete filling station.
- Any additional repair work required can be inexpensively performed at the same time.

We also offer a **10-year Complete Care Package**.

The package includes the following services:

- inspection by experts after 2.5 and 7.5 years
- tank replacement service after 5 years
- scheduling of inspection dates



DT-Mobil PRO PE 980 Basic, with pump Cematic Duo



DT-Mobil PRO PE COMBI 850/100 Basic, with pump Cematic Duo

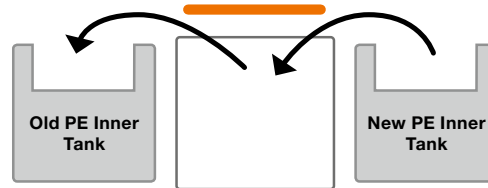

### Description

Description	Order no.
Replacement of the inner tank of the PRO PE versions, including ADR test certificate	10874
Replacement of the inner tank of the PRO PE COMBI versions, including ADR test certificate	10875
10-year* Complete Care Package (including two expert inspections and container replacement according to ADR for version PRO PE).	11287
10-year* Complete Care Package (including two expert inspections and container replacement according to ADR for version PRO PE COMBI).	11288

\* valid from date of manufacture

## TANK SYSTEMS PREMIUM PLUS AND PLUS SIM\*\*\* WITH MANAGEMENT SYSTEM CMO10

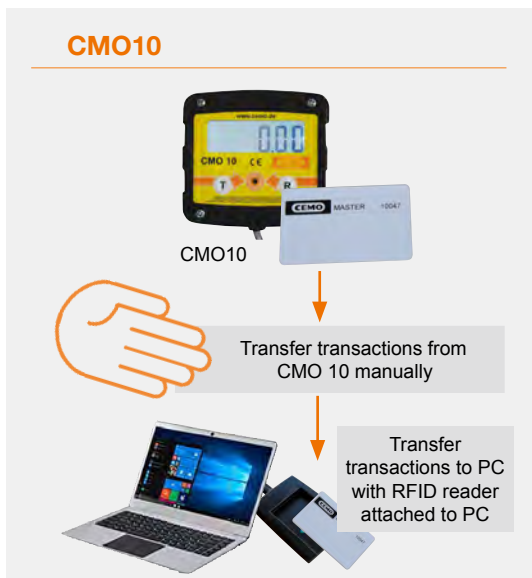

# CEMO DT MOBIL PG 4

## Tank system

### for mobile outdoor and indoor use

indefinite certification period

- certified for transport under ADR
- capacity 400, 600 or 980 litre, i.e. lower than the permitted limit of 1000 litres as per ADR chapter 1.1.3.6.3.
- galvanised
- with two crane eyes and forklift pockets
- protection ring for pump system
- dip stick
- discharge line R 1", lockable
- vent pipe R 1½", lockable
- filling connection R 2", lockable
- DT 980 with overflow prevention sensor
- for orders of 5 or more, available in company colours

### Double-wall model:

- also certified as a storage container according to DIN 6623
- certified for water-protected areas\*
- with bund alarm

### Single-wall model:

if used in water-protected areas, a bund is to be provided

Examinations every 2½ years corresponding ADR 6.5.4.4.1 b and ADR 6.5.4.4.2 b.



Pump cabinet model  
double-wall, hot galvanised



Pump hood model  
double-wall, hot galvanised (see also Mobile package 980 L)

## TOP SELLER

### MOBILE PACKAGE

Order no. 10287

Diesel

## MOBILE PACKAGE 980 L

Description	Order no.
DT-Mobil980 L <u>double-wall</u> , galvanised, with lockable pump hood (Order no. 7386) and pump 12V, 50 L/min, with automatic nozzle and 4 m dispensing hose (Order no. 7981)	10287

## DT-MOBIL SINGLE-WALL, GALVANISED

DIESEL TANK SYSTEM AS DESCRIBED ABOVE,

CERTIFICATION NO.: D/BAM 6167/31A (400 L AND 600 L), D/BAM 5454/31A (980 L)

Double-sided hot galvanised model	Capacity L	Dimensions in cm (l x w x h)	Weight approx. kg	Order no.
A with lockable pump hood, completely assembled (without pump etc.)	400	95 x 95 x 147	146	7316
	600	95 x 95 x 176	171,5	7314
	980	120 x 120 x 177	179,5	7233
B with lockable pump cabinet, completely assembled (without pump etc.)	400	95 x 95 x 147	160	7746
	600	95 x 95 x 177	185	7747
	980	120 x 120 x 177	193	7748

## DT-MOBIL DOUBLE-WALL, GALVANISED

DIESEL TANK SYSTEM AS DESCRIBED ABOVE,

CERTIFICATION NO.: D/BAM 6599/31A (400 L AND 600 L GALVANISED), D/BAM 6600/31A (980 L GALVANISED)

Double sided hot galvanised model	Capacity L	Dimensions in cm (l x w x h)	Weight approx. kg	Order no.
A with lockable pump hood, completely assembled (without pump etc.)	400	96 x 96 x 150	216	7577
	600	96 x 96 x 177	258	7578
	980	121 x 121 x 181	305	7386
B with lockable pump cabinet, completely assembled (without pump etc.)	400	96 x 96 x 150	229	7749
	600	96 x 96 x 177	271	7750
	980	121 x 121 x 181	318	7751

\* National installation laws and conditions must be observed. We will be happy to advise you.



# CEMO DT MOBIL PG 4

Diesel

## Tank system

### for mobile outdoor and indoor use

indefinite certification period

- certified for transport under ADR
- capacity 980 litre, i.e. under the permitted limit of 1000 litres as per ADR chapter 1.1.3.6.3.
- **Painted**
- with two crane eyes and forklift pockets
- protection ring for pump system
- dip stick
- discharge line R 1", lockable
- ventilation pipe R 1½", lockable
- filling connection R 2", lockable
- DT 980 with overfill prevention sensor
- for orders of 5 or more, available in custom colours.

### Double-wall model:

- also certified as a storage container according to DIN 6623
- certified for water-protected areas\*
- with bund alarm

### Single-wall model:

if used in water-protected areas, a bund is to be provided

Examinations every 2½ years corresponding ADR 6.5.4.4.1 b and ADR 6.5.4.4.2 b.



Pump hood model  
double-wall, painted  
(see also mobile package 980 L)

**TOP SELLER**  
**MOBILE PACKAGE**  
Order no. 7216 + 7858

## MOBILE PACKAGE 980 L

Description	Order no.
DT-Mobil980 L <b>single-wall</b> , painted, with lockable pump hood (Order no. 8587) and pump 12V, 50 L/min, with automatic nozzle and 4 m dispensing hose (Order no. 7981)	7216
DT-Mobil980 L <b>double-wall</b> , painted, with lockable pump hood (Order no. 7384) and pump 12V, 50 L/min, with automatic nozzle and 4 m dispensing hose (Order no. 7981)	7858

## DT-MOBIL SINGLE-WALL, PAINTED

DIESEL TANK SYSTEM AS DESCRIBED ABOVE  
CERTIFICATION NO.: D/BAM 5454/31A (980 L)

also suitable for  
**Biodiesel**  
**Vegetable oils**

Painted model***	Capacity L	Dimensions in cm (l x w x h)	Weight approx. kg	Order no.
A without pump hood, fully assembled (without pump etc.)	980	120 x 120 x 126	175	8586
B with lockable pump hood, fully assembled (without pump etc.)	980	120 x 120 x 177	179.5	8587

## DT-MOBIL DOUBLE-WALL, PAINTED

DIESEL TANK SYSTEM AS DESCRIBED ABOVE  
CERTIFICATION NO.: D/BAM 6600/31A (980 L PAINTED)

also suitable for  
**Biodiesel**  
**Vegetable oils**

Painted model***	Capacity L	Dimensions in cm (l x w x h)	Weight approx. kg	Order no.
A without pump hood, fully assembled (without pump etc.)	980	122 x 122 x 141	300	7383
B with lockable pump hood, fully assembled (without pump etc.)	980	122 x 122 x 177	305	7384













\*\*\* For orders of 5 or more, available in custom colours.

Complete assembly of the DT-Mobilwith pump	8379
--	------

\* National installation laws and conditions must be observed. We will be happy to advise you.

# CEMO DT MOBIL PG 4

## ACCESSORIES SUITABLE FOR SINGLE- AND DOUBLE-WALLED MOBILE DIESEL TANK SYSTEM PG 4

Description	Order no.
 <p>Lockable pump hood (included in model B)</p>	7219
 <p>Lockable pump cabinet with dispensing nozzle holder</p>	7763
 <p>Hand pump, 30 L/min, with manual nozzle and 4 m dispensing hose, Viton gaskets</p> <p style="text-align: right;"><b>NEW</b></p>	11683
 <p>Pump 12 V, 50 L/min, with automatic nozzle and 4 m dispensing hose</p>	7981
 <p>Pump 24 V, 70 L/min, with automatic nozzle and 4 m dispensing hose (can also be operated at 12 V, in which case the pump dispensing volume is 35 L/min.) Reliably self-priming only for operation with 24 V.</p>	7982
 <p>Pump 230 V, 50 L/min, with automatic nozzle and 4 m dispensing hose</p>	7222
 <p>Pump 230 V, 80 L/min, with truck automatic nozzle and 6 m dispensing hose DN 25</p>	10689
 <p>K33 meter for hand pump and electric pump</p>	7753
 <p>Extension hose DN 19 for electric pump approx. 50 L/min</p>	<p>2 m, with 1" connection 7071</p> <p>4 m, with 1" connection 7072</p>
 <p>Splash guard insert for DT-Mobil dispensing nozzle filling A splash guard insert was developed to simplify the filling of mobile diesel tank systems using dispensing nozzles. This splash guard insert is simply inserted into the filler neck. It serves as a sealing element between the filler neck of the DT-Mobil and the outlet nozzle of the dispensing nozzle. After filling, the splash guard insert can remain in the filler neck.</p>	8272
 <p>Battery cable, 2.3 m, with 3-pin European standard socket</p>	8194
 <p>Ratchet tie-down 35 mm x 3 m, 2-piece with hooks</p>	8834
 <p>Adhesive label set for retrofitting der DT-Mobil and KS-MOBIL</p>	10261

For additional hose lengths, see page 116.

# CEMO DT MOBIL horizontal PG 4

Diesel

## Tank system for mobile outdoor and indoor use with general construction inspection certification no. PA-06-W 187

- indefinite certification period
- certified for transport under ADR
- size 980 L certified as storage tank according to DIN 6624-2
- also ideally suited for biodiesel and diesel with increased biodiesel content
- certified for water-protected areas
- double-wall
- painted (for orders of 5 or more, available in company colours)
- two crane eyes and forklift pockets
- dip stick, overfill prevention sensor and bund alarm

Examinations every 2½ years according to ADR 6.5.4.4.1 b and ADR 6.5.4.4.2 b.



### Robust cabinet:

- lockable, tamper-resistant
- protection against pump system damage
- 2 x stacking of the system when full (Size 980 L), tested to 4x safety (6t)
- discharge pipe R 1", lockable
- vent pipe R 1½", lockable
- filling connection R 2", lockable

also suitable for  
**Biodiesel**  
**Vegetable oils**







## DT-MOBIL DOUBLE-WALL, HORIZONTAL

Description	Capacity L	Dimensions in cm (l x w x h)	Weight approx. kg	Order no.
double-wall horizontal	980	136 x 105 x 160	450	7765
double-wall horizontal*	2000	190 x 130 x 185	650	8837
double-wall horizontal*	2500	240 x 130 x 185	750	8838
double-wall horizontal*	3000	170 x 165 x 220	780	8839

\*built to order

## ACCESSORIES

Description	Order no.
 Pump 12 V, 50 L/min, with automatic nozzle and 4 m dispensing hose	7981
 Pump 24 V, 70 L/min, with automatic nozzle and 4 m dispensing hose (can also be operated at 12 V, in which case the pump dispensing volume is 35 L/min.) Reliably self-priming only for operation with 24 V!	7982
 Pump 230 V, 50 L/min, with automatic nozzle and 4 m dispensing hose	7222
 Pump 230 V, 80 L/min, with truck automatic nozzle and 6 m dispensing hose DN 25	10689
 K33 flow meter for electric pump	7753

More accessories see page 57.



# Reliable energy supply for mobile heaters and generators

Mobile diesel and heating oil tanks for fan heaters and power generators

Indoor and outdoor

Transport-friendly with tyres, forklift pockets or foot pallet

Capacities from 60 to 1,500 litres



## CEMO MULTI tank PG 4

### Tank

- made of HDPE with integral galvanised sheet steel bund
- with rigidly connected sheet steel pallet for handling with a forklift or pallet truck from any of the four sides
- standard accessories: filling contents gauge, visual bund alarm, integral carrying handles

- no pump
- for storage of diesel, biodiesel without a bund, even in water-protected areas\*
- certified for installation indoors

### Particular advantages:

- certified for transport according to the ADR, but without a pump fitted – examination after 2½ years (see ADR 6.5.4.4.1 b and ADR 6.5.4.4.2 b).\*\*\*
- lower centre of gravity increases stability and improves handling/transport



Capacity L	Dimensions cm (l x w x h)	Certification no. for storage and transport	Weight approx. kg	Order no.
400	73 x 74 x 117	Z-40.21-365 / D/BAM6403/31HA1	55	7536
750	98 x 80 x 146	Z-40.21-288 / D/BAM11580/31HA1	82	7381
1000	128 x 80 x 147	Z-40.21-288 / D/BAM11581/31HA1	100	7382
1500	164 x 80 x 191	Z-40.21-432 / D/BAM6404/31HA1	165	7539

\* National installation laws and conditions must be observed.  
 \*\*\*The transport certification for all plastic-IBC is limited to 5 years.

Accessories see page 27.

## CEMO diesel and heating oil trolley PG 4

The mobile solution for supplying heating systems and generators.  
The trolley can be used as an emergency supply when a heating oil tank is being replaced.

### Diesel and heating oil trolley 60 L and 100 L

- suitable for use under ADR 1.1.3.1 c) for single site refuelling by a person in the course of their main business
- polyethylene container with integral hand grip and carry handles
- fill cap with integral breather valve
- flow connector with 3/8" quick-coupling with counterpart
- return connector with 3/8" quick-coupling with counterpart
- trolley 100 L: 300mm diameter pneumatic tyres, air-filled, all-terrain
- trolley 60 L: 240mm diameter plastic tyres
- interior baffle
- trolley 100 L: moulded recesses enabling strapping during transport



Description/Capacity	Dimensions in cm (l x w x h)	Weight approx. kg	Order no.
Diesel and heating oil trolley 60 L with quick couplings	90 x 53 x 38	12	10526
Diesel and heating oil trolley 100 L with quick couplings	100 x 59 x 43	17	10527

## CEMO DT MOBIL EASY generator tank PG 4

The innovative diesel and heating oil tank with a wealth of useful features.  
Transport-friendly thanks to rugged construction, ratchet strap recesses and forklift pockets.

### DT-Mobil EASY generator tank

- 980 litre: certified for transport according to the ADR\*
- 210 and 440 litre: certified for transport for immediate consumption according to ADR 1.1.3.1 c)
- integral filler neck
- filler cap with vent and breather valves
- integral forklift pockets and handles
- integral recesses (210 L and 440 L) or loops (980 L) for ratchet tie-downs during transport
- 980 litre: incl. hinged lid and fill-level indicator
- 210 and 440 litre: incl. hinged lid

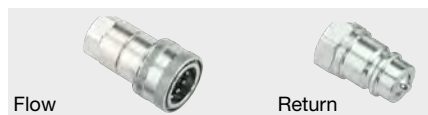

Flow and return braided hoses and two pairs of quick couplings 1/2" IT ideal for generators and heaters.



Description	Capacity L	Dimensions in cm (l x w x h)	Weight approx. kg	Order no.
210 generator tank	210	78.5 x 59.5 x 68.5	21	11374
440 generator tank	440	118 x 80 x 71	36	11375
980 generator tank	980	127 x 107 x 112	95	11376

\* Please note that ADR certification for all combination IBCs with plastic inner tanks for diesel is limited to a period of 5 years.

# CEMO DT MOBIL PRO generator tank PG 4

# CEMO CUBE MOBIL generator tank PG 4

Our new DT-Mobil PRO tank is characterised by its extremely high strength due to the steel outer container with hot-dip galvanised steel forklift pockets and stacking corners with crane eyes. The new CUBE-Tank Mobile impresses with its PE sump due to its lower weight.

- certified for transport under ADR (980 L)
- with connections with quick-coupling for marquee heaters and power generators
- **DT-Mobil PRO PE 440 generator tank:** with inner tank for diesel made of polyethylene, ADR certified 1.1.3.1 c), with flow and return hoses with quick-coupling
- **DT-Mobil PRO PE 980 generator tank:** with inner tank for diesel made of polyethylene\*\*\* with flow and return hoses with quick-coupling (1 x flow, 1 x return)
- **DT-Mobil PRO ST 980 generator tank:** Certification for unlimited period of time, with inner tank for diesel made from painted 3 mm steel sheet, with 4 connections with quick-coupling (2 x flow, 2 x return) with overflow prevention sensor
- **CUBE Mobil generator tank 980:** with inner tank and bund made of polyethylene\*\*\* with 2 connections with quick-coupling (1 x flow, 1 x return)



DT-Mobil PRO ST 980 generator tank

Examination every 2 ½ years (see ADR 6.5.4.4.1 b and ADR 6.5.4.4.2 b).

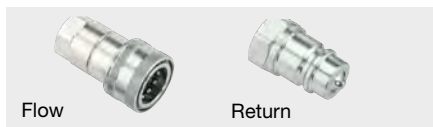

Delivery line with quick coupling set each with counterpart and 1/2" internal thread connection for flow and return line suitable for mobile oil heaters and generators



CUBE Mobil 980 generator tank with two connections



**DT-Mobil PRO** Outer container in steel, inner container in steel or PE



DT-Mobil PRO PE 980 generator tank with two connections



DT-Mobil PRO ST 980 Basic generator tank with four connections



Protected hose routing

Description	Capacity L	External dimensions cm (l x w x h)	Weight approx. kg	Order no.
DT-Mobil PRO 440 PE generator tank with 2 connections with quick-coupling (1 x flow, 1 x return)	440	125 x 87 x 107	196	11378
DT-Mobil PRO 980 PE generator tank with 2 connections with quick-coupling (1 x flow, 1 x return)	980	136 x 115 x 130	325	11377
DT-Mobil PRO 980 ST generator tank with 4 connections with quick-coupling (2 x flow, 2 x return)	980	136 x 115 x 118	430	11430
CUBE Mobil 980 generator tank with 2 connections with quick-coupling <b>NEW</b>	980	130 x 112 x 118	100	11679

## ACCESSORIES

Description	Order no.
Generator and heater connection set with quick couplings (1/2" flow and return braided hoses) for DT-Mobil PRO ST	11506

Lifting frame accessory see page 48.

## TANK REPLACEMENT SERVICE see page 54

\*\*\* Please note that ADR certification is limited to 5 years for all combination IBCs with a plastic inner tank for diesel. The inner tank must be replaced after this time. We offer this tank replacement service.





# TANK SYSTEMS FOR PETROL





## Tank systems for petrol (p. 64-71)



### CANISTERS

- 5 L to 25 L
- model with explosion-proof filling
- models with nozzle pump

69

Petrol



flashback arrester



### CEMO petrol trolley

- 60 L + 95 L
- mobile tank system for petrol
- suitable for use under ADR 1.1.3.1 c) for single site refuelling by a person in the course of their main business
- container constructed from high density electrically conductive polyethylene to eliminate static
- flashback arrester
- large tyres, all-terrain

70

### CEMO KS MOBIL EASY

- 120 L + 190 L + 330 L
- mobile tank system for petrol
- certified for transport according to ADR
- electrically conductive highly cross-linked polyethylene
- patented flame suppressant filling

70



Explosion pressure resistant



66

### CEMO KS MOBIL

- 90 L - 300 L
- mobile tank system for petrol
- certified for transport under ADR
- explosion shock proof construction

68

### CEMO KS MOBIL

- 400 L - 980 L
- mobile tank system for petrol
- certified for transport according to ADR, also in water-protected areas
- certified as a storage tank according to DIN 6623
- explosion shock proof construction

Airfield tank systems on request



# Tank systems for petrol

## IMPORTANT LEGAL CONDITIONS FOR HANDLING PETROL

The requirements for handling petrol (H 224) are comparable to those of diesel fuel (H 226), but are somewhat stricter. The more stringent requirements are due to the usually higher water hazard class in accordance with the German Water Management Act and to the lower flash point (extremely flammable liquid according to GHS) of petrol. The more stringent requirements are described below.

### Storing petrol

There are many laws and regulations that must be complied with when storing petrol. Excerpts from the German Ordinance on Industrial Safety and Health (Betriebssicherheitsverordnung (BetrSichV)), the German Water Management Act (Wasserhaushaltsgesetz (WHG)), the German Technical Regulations for Hazardous Substances (Technische Regel Gefahrstoffe (TRGS)) and

the regulations related to garages in Germany (Garagenverordnung) are given here. These regulations clearly define the permissible storage quantities, storage site requirements, and the risk assessments required by the employer. This information has been clearly organised in the following table. For storage tanks with a capacity of 200 L or more, a restraining device is required if the tanks do not have a double-walled design.

	Technical Regulations for Hazardous Substances (TRGS) 510	Ordinance on Industrial Safety and Health (BetrSichV)	Water Management Act (WHG)	Regulations on Garages (Garagenverordnung)
Storage in homes	no			
Storage in basements	not regulated			
Storage in retail areas	not regulated	Risk assessment required due to risk of explosion	General duty of care under Section 5 and Duty of Care Principle Section 62	
Storage in work areas	regulation for small quantities applies up to 10 L; quantities exceeding 10 L must be stored in an F90 safety cabinet or hazardous materials storage area			
Storage in garages				20 L in small garages up to 100 m <sup>2</sup> , not permitted in larger garages
Storage outdoors	Active storage – distance of 10 m from building; passive storage up to 200 L – distance of 3 m; passive storage up to <1,000 L – distance of 5 m from building	Risk assessment required due to risk of explosion		

### Transporting petrol

The following regulations must be observed when transporting petrol (see page 32). They go above and beyond the scope of requirements for transporting diesel fuel.

- Maximum quantity as defined in table 1.1.3.6 ADR (1000 point rule) is 333 l. For quantities greater than this, a dangerous goods driving licence is generally required and the German Craftsman Regulation in accordance with ADR 1.1.3.1 c) no longer applies.
- Mobile fuel filling stations with ADR certification require this for packaging groups II and III.

### Transferring and filling petrol

The Ordinance on Industrial Safety and Health (BetrSichV) is the German implementation of European Directive 95/63/EC and regulates the provision of equipment by the employer. This also includes the risk assessment of the equipment, which in turn includes the assessment of the risk of explosion in accordance with TRBS 2152 Part 1. If the formation of hazardous, explosive atmospheres cannot be prevented with certainty, the employer is to assess the following:

1. the probability and duration of the occurrence of a hazardous, explosive atmosphere,

2. the probability of the existence or creation and the coming into effect of ignition sources, including electrostatic discharges, and
3. the extent of the effects to be expected from explosions.

The assessment must refer to the specific local and operating conditions.

**Note:** More than 10 litres of contiguous explosive atmosphere in enclosed spaces must be viewed as a hazardous explosive atmosphere, regardless of the size of the space.

### What does this mean for you in your day-to-day work?

In general, the transferring and filling of petrol must be done in well ventilated rooms or outdoors.

According to the Ordinance on Industrial Safety and Health, you should only provide devices/equipment that are state of the art. In addition, you should pay special attention to the risk assessment when handling petrol. The best option for reducing the risk is never to allow a contiguous explosive atmosphere of more than 10 litres to form in the first place. The current state of the art only enables this to be achieved inside containers in use by means of explosion-suppressing inserts.

Another option is to prevent the explosive atmosphere from being ignited by ignition sparks by placing flame arresters into the container openings.

If the container has an explosion-proof design, neither an explosion-suppressing insert nor a flame arrester is required up to a container size of 1000 l. As a rule, explosion-proof containers are made from thick-walled sheet steel, although they have the disadvantage of being very heavy.

Should you use equipment that is manufactured without explosion-suppressing inserts or flame arresters, the probability of the existence or creation and the coming into effect of ignition sources, including electrostatic discharges, is to be especially assessed. In practice, this is very difficult to achieve with changing types of work (forest, road, constructions sites or in the workshop). As a rule, the creation of sources of ignition and electrostatic charge cannot be fully prevented and therefore ruled out safely enough.

We therefore recommend using canisters or containers > 10 L, which are not designed to be explosion-proof, with explosion-suppressing inserts or flame arresters. Important information related to risk assessments can be found in the operating instructions for CEMO petrol tank systems. This will make it easier for you to fulfil your obligations as an employer.

# CEMO KS MOBIL PG 4

## Mobile fuel tank systems for petrol

**Tank system KS-MOBIL double-walled with general construction inspection certification no. D/BAM 6599/31A (400 L and 600 L), D/BAM 6600/31A (980 L)**

- for mobile outdoor and indoor use
- indefinite certification period
- certified for transport under ADR, also in water-protected areas\*
- certified as a storage tank according to DIN 6623
- certified for petrol
- capacity 400, 600 or 980 litre
- design approved as a complete system in all variations
- KS-MOBIL for bioethanol on request

**Construction:**

- double-walled steel container
- explosion shock proof construction
- with two crane eyes
- forklift pockets
- guard ring for pump system
- dip stick
- discharge line R 1", lockable
- ventilation pipe R 2", lockable
- filling connection R 2", lockable
- bund alarm and overflow prevention sensor
- long, removable ventilation pipe (3 m above ground)

Examinations every 2½ years corresponding ADR 6.5.4.4.1 b and ADR 6.5.4.4.2 b.



Model with pump cabinet, double-walled, hot galvanised, design approved







Explosion pressure resistant

### KS-MOBIL DOUBLE-WALL

Double sided hot galvanised model		Capacity L	Dimensions in cm (l x w x h)	Weight approx. kg	Order no.
1.	without pump hood, completely assembled (without pump etc.)	400	96 x 96 x 114	211	7754
		600	96 x 96 x 141	253	7755
		980	121 x 121 x 141	300	7756
2.	with lockable pump cabinet, completely assembled (without pump etc.)	400	96 x 96 x 150	229	7760
		600	96 x 96 x 177	271	7761
		980	121 x 121 x 181	318	7762

### ACCESSORIES SUITABLE FOR MOBILE FUELING SYSTEMS





Description	Order no.
 <p>Lockable pump cabinet with dispensing nozzle holder (included in model 2)</p>	7763
 <p>Dispensing hose for gasoline/petrol for extension or as a replacement, 4 m, coupling nut on one side, other side 1" outer thread</p>	8521
 <p>Automatic dispensing nozzle for petrol, EN13012, ATEX, with swivel joint 1" internal thread</p>	10142
 <p>Adhesive label set for DT-Mobil and KS-MOBIL retrofitting</p>	10261

According to TRbF (German Technical Regulations for Combustible Liquids), if actively storing petrol, a distance of 10 m between the container and building must be maintained, unless the building wall is constructed according to TRbF or there are fire-resistant components of sufficient width and height between the building and the container (e.g. F90 fire prevention store). According to health and safety regulations, all filling stations for petrol must have a permission (applicable when used as fixed filling station). We will be happy to advise.  
Please note: The permitted max. amount for petrol is according to ADR chapter 1.1.3.6.3, 333 L (basic requirements, e.g. no dangerous good driving permit necessary).

\* National installation laws and conditions must be observed. We will be happy to advise you.

# Fuel tank systems, stationary and mobile PG 4

## PUMPS SUITABLE FOR PETROL TANK SYSTEMS

Description		Order no.
 <p>Hand pump, 30 L/min, with manual nozzle, 4 m dispensing hose, Viton gaskets</p>	<b>NEW</b>	11683
 <p>Pump, approx. 40 L/min, ATEX, 12 V, with automatic nozzle, 4 m dispensing hose</p>		10257
 <p>Pump, approx. 40 L/min, ATEX, 230 V, with automatic nozzle, 4 m dispensing hose</p>		10259
 <p>Pump, approx. 40 L/min, with meter, ATEX, 12 V, with automatic nozzle, 4 m dispensing hose</p>		10258
 <p>Pump, approx. 40 L/min, with meter, ATEX, 230 V, with automatic nozzle, 4 m dispensing hose</p>		10260
Complete assembly of the KS-MOBIL with pump		8379





Electric pumps for petrol are supplied without connection cable. For matching accessories, see page 124. According to Directive 2009/104/EC (in Germany the Industrial Safety Ordinance BetrSichV) or other valid national regulations, the electrical connection must be carried out professionally and in accordance with the regulations according to a risk assessment performed by the local operator.

## Accessory funnel with filter and water separator PG 4

### Funnel with filter and water separator, suitable for aircraft fuelling

It is practically impossible to avoid dirt and water in fuels. That leads to blocked filters, corrosion, motor failure and even motor damage. The filter membrane of the funnel reliably holds back dirt and water. This settles on the bottom and can be easily disposed of.



Description		Order no.
 <p>Funnel with water separator and filter F3C, max. 13 L/min, electrically conductive</p>		10515
 <p>Funnel with water separator and filter F15C, max. 45 L/min, electrically conductive</p>		10516



# CEMO KS MOBIL PG 4

ADR CERTIFIED

Petrol

**KS-MOBIL 90 L and 200 L** with general construction inspection certification no. D/BAM 13136/31A (90 L), D/BAM 13137/31A (200 L), D/BAM 15331/31A (300 L)

- certified for transport under ADR
- individual refuelling systems for mobile use indoors and out
- explosion shock proof construction (TÜV-tested), therefore also suitable for petrol and oil/petrol mixtures
- single-wall steel container from 3 mm sheet steel, painted
- with handles that can also be used as crane eyes
- forklift pockets
- pump box lockable
- delivery line lockable
- filling connection 1½"
- dipstick

Pre-fitted pump:

- 25 L/min hand pump, 1.5 m filling hose (statically conductive) and manual nozzle
- self-priming pump 12 V, 25 L/min, ATEX-certified, automatic nozzle, 4 m dispensing hose (statically conductive) and 4.1 m electrical cable

Examinations every 2½ years corresponding ADR 6.5.4.4.1 b and ADR 6.5.4.4.2 b.



Pump cabinet (KS-MOBIL 300 L) with pump 12 V, 25 L/min, ATEX, hose reel (accessory) and automatic nozzle

Petrol and petrol mixtures



Explosion pressure resistant



Pump cabinet (KS-MOBIL 200 L) with pump 12 V, 25 L/min, ATEX, 4 m discharge hose and automatic dispensing nozzle



KS-MOBIL 200 L



KS-MOBIL 90 L

Description/Capacity	Dimensions cm (l x w x h)	Weight approx. kg	Order no.
90 L with hand pump 25 L/min	80 x 40 x 74	60	8840
200 L with hand pump 25 L/min	80 x 60 x 95	77	10025
200 L with pump 12V, 25 L/min, ATEX and automatic nozzle	80 x 60 x 95	79	10755
300 L with hand pump 25 L/min	120 x 60 x 108	110	10994
300 L with pump 12V, 25 L/min, ATEX and automatic nozzle	120 x 60 x 108	112	10995

## ACCESSORY FOR KS-MOBIL 300 L

Description	Order no.
Hose reel with 10 m hose DN 19, electrically conductive, for petrol	10996

# CEMO Canister | petrol trolley PG 4

## Ex0 Canister non-explosive

- ADR certified
- container made from HDPE
- patented explosion and shockproof insert
- fulfils the highest safety requirements
- child safety lock
- spout integrated in the canister
- fits commercially available canister holders
- stackable to save space



Ex0 canister, 20 L and 10 L

## Canister 25 L with dispensing nozzle pump

- HD-PE container 25 L
- approved for the transport of fuel
- handle for easy use
- nozzle with integral hand pump, up to 7.5 L/min, with locking latch on trigger guard
- 1.5 m flexible delivery hose

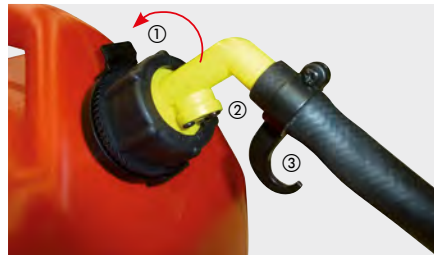

- ① Knurled nut for securing the locking cap
- ② Vent valve
- ③ Delivery nozzle holder



Canister 25 L with nozzle pump

Description/Capacity	Dimensions in cm (l x w x h)	Weight approx. kg	Order no.
Ex0 Canister 10 L with explosion-proof filling	35 x 17 x 31	2	10268
Ex0 Canister 20 L with explosion-proof filling	35 x 17 x 49.5	3	10269
Canister 25L with nozzle pump	36 x 24 x 43	2.1	11367

**Important notice:** All petrol canisters must be labelled with safety and danger signs (10 x 10 cm) according to health and safety regulations.



## Petrol trolley 53 L

- UN certified for the transport of fuel
- HD-PE container 53 L with wheel and handle for maneuverability
- container constructed from high density electrically conductive polyethylene to eliminate static (optional)
- dispensing nozzle pump, 7.5 L/min, with 3 m delivery hose and locking catch for the trigger guard
- baffle
- filling nozzles with integrated vent
- 2 shut-off valves for problem-free removal of the delivery hose
- integrated recesses for securing the trolley with ratchet lashing strap during transport
- designed to siphon after priming with hand pump



Description/Capacity	Dimensions in cm (l x w x h)	Weight approx. kg	Order no.
Petrol trolley 53L	87 x 42 x 33	9	10047



## CEMO petrol trolley 60 and 95 L PG 4

Petrol

- suitable for use under ADR 1.1.3.1 c) for single site refuelling by a person in the course of their main business
- container constructed from high density electrically conductive polyethylene to eliminate static
- flashback arrester
- integral grip and carry handles
- filling cap with integral breather valve
- delivery hose with stop valve
- handpump 25 L/min and nozzle
- with pump 12V, 25 L/min, automatic nozzle, 4.1 m cable with battery terminals
- trolley 95 L: 300mm diameter pneumatic tyres, air-filled, all-terrain; 3.2m conductive dispensing hose
- trolley 60 L: 240mm diameter plastic tyres; 2.7 m conductive dispensing hose
- internal baffle
- integral nozzle holder
- trolley 95 L: moulded recesses for strapping during transport



60 L with hand pump







95 L with hand pump



95 L with electric pump



Flashback arrester

Description/Capacity		Dimensions in cm (l x w x h)	Weight approx. kg	Order no.
Petrol trolley Ex0*** 60L, with hand pump		90 x 53 x 38	18	10507
Petrol trolley Ex0*** 95L, with hand pump		100 x 59 x 43	20	10162
Petrol trolley Ex0*** 60L, with electric pump		90 x 53 x 38	20	10508
Petrol trolley Ex0*** 95L, with electric pump		100 x 59 x 43	22	10646

\* explosion-suppressing insert \*\*\* with flashback arrester

## CEMO KS MOBIL EASY 120 and 190 L PG 4

ADR CERTIFIED

**KS-MOBIL Easy 120 L and 190 L certified for transport under ADR certification no. D/BAM 14341/31H2**

Examinations every 2½ years corresponding ADR 6.5.4.4.1 b\*\*\* and ADR 6.5.4.4.2b. Completely assembled.

Container:

- single-walled 120 L or 190 L
- electrically conductive highly cross-linked polyethylene
- patented flame suppressant filling
- dipstick for checking fill level
- integral dispensing nozzle holder
- integral filler neck
- integral vent and pressure relief
- integral forklift pockets
- integral handles
- integral recesses for ratchet straps during transport

Pre-fitted pump:

- 25 L/min hand pump, 2.7 m dispensing hose (statically conductive) and manual nozzle
- self-priming pump 12V DC 25 L/min or 230V AC 40 L/min, ATEX-certified, automatic dispensing nozzle, 4 m filling hose (statically conductive) and 5 m electrical cable (pump 230V without cable)

KS-MOBIL Easy 190 L with hand pump and hinged lid



KS-MOBIL Easy 120 L with pump 12V



Explosion-suppressing insert (patent protected), hence no explosive atmosphere inside the container (120 L and 190 L)

\*\*\* The transport certification for all plastic IBCs is limited to 5 years.



# Mobile tank systems for petrol

## CEMO KS MOBIL EASY 120 and 190 L PG 4

ADR CERTIFIED

Capacity / Description	Dimensions cm (l x w x h)	Weight approx. kg	Order no.
120L with hand pump	80 x 60 x 45	23	10091
120L with pump 12V, 25 L/min, ATEX and automatic nozzle	80 x 60 x 45	33	11498
120L with hand pump and hinged lid	80 x 60 x 47	26	10092
120L with pump 12V, 25 L/min, ATEX, automatic nozzle and hinged lid	80 x 60 x 47	36	11499
190L with hand pump	80 x 60 x 59	25	10093
190L with pump 12V, 25 L/min, ATEX and automatic nozzle	80 x 60 x 59	35	11500
190L with hand pump and hinged lid	80 x 60 x 61	28	10094
190L with pump 12V, 25 L/min, ATEX, automatic nozzle and hinged lid	80 x 60 x 61	38	11501
190L with pump 230V, 40 L/min, ATEX and automatic nozzle	80 x 60 x 59	35	10458

## CEMO KS-MOBIL EASY 330 L PG 4

Petrol and petrol mixtures

**Basic and Premium versions certified for transport under ADR D/BAM 15862/31H2**

Examinations every 2½ years corresponding ADR 6.5.4.4.1 b\*\*\* and ADR 6.5.4.4.2 b.

- compact design, easy to use
- all components at optimum working height
- container made of electrically conductive, highly cross-linked polyethylene
- lockable lid with steel support stays
- flashback arrestor
- contents gauge
- integral dispensing nozzle holder
- integral filler neck
- filler cap with vent and breather valves
- integral baffle
- integral forklift pockets
- integral handles
- integral recesses for ratchet straps during transport
- with self-priming pump, 12 V DC, 25 L/min\*, with ATEX certification, automatic nozzle and 5 m cable
- fully assembled



flashback arrestor (330 L)

KS-Mobil Easy 330 L **Premium** with hose reel and galvanised steel base

### Basic version

with 4 m dispensing hose DN 19, electrically conductive, 2 m earthing conductor with terminal clamp

### Premium version

with hose reel with 10 m hose DN 19, electrically conductive, 10 m earthing conductor with terminal clamp with sturdy galvanised steel base, forklift-able from four sides



KS-Mobil Easy 330 L **Basic**

Description	External dimensions in cm (l x w x h)	Weight (approx.) in kg	Order no.
<b>KS MOBIL Easy 330 L Basic</b>	118 x 79 x 57	42	11502
<b>KS MOBIL Easy 330 L Premium</b>	144 x 80 x 67	84	11361

ACCESSORY	Order no.
Digital flow meter K24 A ATEX for mounting between dispensing hose and automatic nozzle	10411

\* Pump dispensing volume in free flow. Please note that the pump dispensing volume can fall sharply depending on the length and cross-sectional area of the hose. \*\*\* The transport certification for all plastic IBCs is limited to 5 years.



# TANK SYSTEMS FOR LUBRICANTS







# CEMO CUBE PG 4

## Stationary tank systems for lubricants

Lubricants

Dispensing station for lubricants, Basic and Premium with general construction inspection certification no. Z-40.21-510

- comprising integrated bund
- visual bund alarm
- tanker coupling
- electronic overfill sensor
- vent
- analogue contents gauge
- suction hose
- 230V electric gear pump 9 L/min at 12 bar (cannot be calibrated)
- integral nozzle holder
- certified for outdoor installation with hinged lid (outdoor model)
- completely assembled

### Electric pumps (technical data)

Pump 230 V (cannot be calibrated\*).  
Gear pump with a delivery rate of 9 L/min, max. delivery pressure 12 bar, suitable for engine, transmission and hydraulic oils up to SAE 140

\* see information on weights and measures regulation on page 76



CUBE-Tank for lubricants  
1,000 L Outdoor Premium

### Fresh oil



230V electric gear pump 9 L/min at 12 bar with digital handheld flow meter for lubricants (cannot be calibrated\*)



CUBE-Tank for lubricants  
1,500 L Outdoor Premium



Accessory hose reel



Accessory LED instrument lighting

Description	Capacity L	External dimensions cm (wxdxh)	Weight approx. kg	Order no.
<u>CUBE-Tank Indoor Basic.</u> 4 m dispensing hose, handheld digital flow meter, cannot be calibrated, without hinged lid	1000	120 x 80 x 174	140	10308
	1500	120 x 115 x 174	170	10309
<u>CUBE-Tank Indoor Premium.</u> hose reel with 15 m dispensing hose, handheld digital flow meter, cannot be calibrated, no lid	1000	120 x 80 x 174	160	10310
	1500	120 x 115 x 174	190	10311
<u>CUBE-Tank Outdoor Premium.</u> hose reel with 15 m dispensing hose, handheld digital flow meter, cannot be calibrated, no lid	1000	120 x 80 x 180	175	10312
	1500	120 x 115 x 180	205	10313
	2500	120 x 180 x 180	260	10424

## ACCESSORIES

Description	Order no.
Hinged lid, orange, complete with supporting gas struts and mounting accessories	10324
Hose reel with 15 m dispensing hose	10423
LED instrument lighting with motion sensor and battery	10378

# CEMO CUBE Waste oil tank PG 4

Collection station for waste oil, indoor and outdoor  
with general construction inspection  
certification no. Z-40.21-510

- integrated bund
- visual bund alarm
- integrated filling funnel with strainer
- integrated drainer for oil-contaminated parts, such as oil filters
- suction pipe with tanker coupling
- breather cap
- contents gauge
- additional 1" and 2" connections
- with hinged lid, certified for installation outdoors (outdoor versions)
- completely assembled

Waste oil

Lubricants



Integrated filling funnel with strainer and drainer for oil-contaminated parts, such as oil filters



Accessory LED instrument lighting



Accessory overfill prevention sensor (only necessary when filling with fixed connection)



CUBE-Waste oil tank  
1,000 L, Outdoor

Description	Capacity L	External dimensions cm (w x d x h)	Weight approx. kg	Order no.
<u>CUBE-Waste oil tank Indoor, without hinged lid</u>	1000	120 x 80 x 174	125	10477
	1500	120 x 115 x 174	155	10478
	2500	120 x 180 x 174	210	10479
<u>CUBE-Waste oil tank Outdoor, with hinged lid</u>	1000	120 x 80 x 180	140	10480
	1500	120 x 115 x 180	170	10481
	2500	120 x 180 x 180	225	10482

## ACCESSORIES

Description	Order no.
Hinged lid, orange, complete with supporting gas struts and mounting accessories	10324
LED instrument lighting with motion sensor and battery	10378
Overfill prevention sensor, complete, supply voltage 230 V, comprising: level transmitter (sensor length 250 mm) with screwed connection R 1", display unit (alarm device) with signal light and buzzer.	10703

# CEMO UNI PG 4

## Stationary tank systems for lubricants pneumatic

**Tank** from HDPE with integral galvanised sheet steel bund, standard accessories such as pallet base, filling contents gauge and visual bund alarm, suction kit, pump, dispensing hose and digital manual flow meter, with holder and drip tray.

Components delivered unmounted to prevent damage during transport. For storage of fresh and waste oil with a flash point >55°C and certified for use in water protected areas without a bund\* when installed indoors.

Fresh oil



Pump 230 V (cannot be calibrated\*) with a delivery rate of 9 L/min and max. delivery pressure of 12 bar

\* see information on weights and measures regulation

### Electric pumps (technical data)

Pump 230 V (cannot be calibrated\*). Gear pump with a delivery rate of 9 L/min, max. delivery pressure 12 bar, suitable for engine, transmission and hydraulic oils up to SAE 140

### Important information regarding the Weights and Measures Regulation (extract)

Regulation on the putting into circulation and provision of measuring devices on the market and on their use and calibration (Weights and Measures Regulations – MessEV)

§ 5

Uses exempt from the scope of application

- (1) The **Weights and Measures Act** and these regulations are **not to be applied** to measuring devices or readings that are used in normal commercial practice
- 6. **in businesses of the motor trade or at public filling stations for determining the volume or the mass of lubricating or transmission oil**, brake fluid, refrigerant for air conditioners, anti-freeze or screenwash

### COMPACT LUBRICANT SYSTEM WITH ELECTRIC PUMP

Type / Capacity L	Dimensions cm (l x w x h)	Hose	Weight approx. kg	Order no.
UNI 750	108 x 77 x 167	4 m, hose holder	90	8251
UNI 750	108 x 77 x 187	15 m, open hose reel	108	8679
① UNI 1000	138 x 77 x 167	4 m, hose holder	114	8252
② UNI 1000	138 x 77 x 187	15 m, open hose reel	132	8680
③ UNI 1500*	187 x 77 x 210	4 m, hose holder	168	8681
④ UNI 1500*	212 x 77 x 210	15 m, open hose reel	188	8682

\* incl. filling connection with TW coupling, breather cap and overflow protection

Accessories see page 127.

\*\*\*\* National installation laws and conditions must be observed. We will be happy to advise you.



# CEMO UNI | MULTI PG 4

## Stationary tank systems for lubricants

### Tank from HDPE with general construction inspection certification

Individual tank with integral galvanised sheet steel bund, standard accessories such as filling contents gauge, visual leakage detector device, integral carrying handle, no pump.

For storage of fresh and waste oil with a flash point > 55 °C also certified for indoor installation and in water protection areas without a bund\*.

**Low overall height** (up to 1,000 L), thus no steps are required when filling with waste oil.

#### UNI-Tank

Tank as described above with foot pallet.

#### MULTI-Tank

Tank as described above with integral sheet steel pallet for moving with a forklift or hand forklift from any of four sides.

Particular advantages:

- certified for transport according to the ADR, but without a pump fitted. Examination after 2½ years (see ADR 6.5.4.4.1 b).\*\*\*
- lower centre of gravity increases stability and improves handling/ transport.



Fresh and waste oil



Base pallets with collision protection

MULTI-Tank series

### UNI-TANK

Capacity L	Dimensions cm (l x w x h)	Certification no.	Weight approx. kg	Order no.
400	73 x 70 x 117	Z-40.21-365	50	7979
750	98 x 77 x 142	Z-40.21-288	66	7379
1000	128 x 77 x 142	Z-40.21-288	89	7380
1500	163 x 77 x 185	Z-40.21-432	151	7881

### MULTI-TANK







Capacity L	Dimensions cm (l x w x h)	Storage and transport Certification no.	Weight approx. kg	Order no.
400	73 x 74 x 117	Z-40.21-365 / D/BAM6403/31 HA1	55	7536
750	98 x 80 x 146	Z-40.21-288 / D/BAM11580/31 HA1	82	7381
1000	128 x 80 x 147	Z-40.21-288 / D/BAM11581/31 HA1	100	7382
1500	164 x 80 x 191	Z-40.21-432 / D/BAM6404/31 HA1	165	7539

\* National installation laws and conditions must be observed. We will be happy to advise you.  
 \*\*\* The transport certification for all plastic-IBC is limited to 5 years.

## CEMO Lubricant tanks PG 4

### ACCESSORIES FOR UNI- AND MULTI-TANK

Fresh and  
waste oil

Description	Order no.
 <p>GRP filling funnel with sealable lid</p>	7389
 <p>Suction pipe with tanker coupling for UNI/MULTI-Tank up to 1,000 L</p>	7390
<p>Suction pipe with tanker coupling for UNI/MULTI-Tank 1,500 L</p>	8323
 <p>Hand pump for engine oils up to SAE 50 for UNI/MULTI-Tank up to 1,000 L</p>	1452
 <p>Overfill prevention complete, supply voltage 230 V, comprising: level sender (probe) with reducer R 1" and ¾", indicator (alarm arrangement) with alarm lamp and buzzer.</p>	11452
 <p>Leakage detector device visual and acoustic</p>	7391
 <p>Ultrasonic contents gauge, suitable for UNI-/MULTI-Tank, all sizes</p>	10275

## CEMO VISCOTROLL – Mobile compact system PG 4

Mobile compact lubricant system is the ideal oil dispenser solution in all cases, where the drum may have to be moved anywhere within the workshop. Thanks to the electric power supply, connection to any type of socket is possible and no compressed air supply is needed. The unit has a self-priming gear pump, which guarantees a constant dispensing volume as well as even, pulsation- and noise-free flow.

A flow meter with a display integrated into the nozzle enables exact metering and volume control of the dispensed liquid.

Pump technical data – see Viscomat lubricant pump 200/2 page 126.

Wheeled drum trolley of tubular construction complete with nozzle holder, hose holder and drip tray, self-priming pump with connected 230 V AC asynchronous motor with self-ventilation (protection category IP 55), 1" suction hose with foot valve and filter, 4 m pressure hose ½", nozzle with flexible end, drop-free automatic valve.

Viscotroll 200/2 with flow meter pressure switch with incorporated safety valve available on request



Description	Weight approx. kg	Order no.
Viscotroll 200/2 with flow meter K 400	35	7910

# CEMO CUBE Profitank 2000 L PG 4

Stationary tank system for lubricants, double walled

Fresh and waste oil

Successor to the legendary CEMO DWT tank with general construction inspection certification (applied for)

- with two connection flanges
- also suitable for water protection areas
- certified for installation outdoors

- Extensive range of accessories such as sturdy steel dome lids for mounting connection hoses and pumps

two connection flanges (Ø 170 mm) for up to 8 connection options

integral bund with leakage detector

contents gauge

easy tank cleaning

100% corrosion resistant

sturdy steel supports



Available from September 2022



**DOUBLE-WALLED** – therefore also certified for water protection areas without external bund!



Description	External dimensions in cm (l x w x h)	Weight (approx.) in kg	Order no.
CUBE-Profitank 2000 L	86 x 180 x 180	180	11665





# CEMO CUBE Profi tank PG 4

## Stationary tank system for fresh and waste oil, double walled





### ACCESSORIES FOR FRESH OIL TANK

Description	Order no.
 <p>Dome lid (steel) with 4 threaded pipe couplings (straight), 2" for filling, also 2", 1 1/2" and 1". Supplied with: a blanking cap for each pipe coupling 2", 1 1/2" and 1".</p>	1436
 <p>Dome lid (steel) with 2 threaded tubes (sloping welded), 1 x 2" for filling, 1 x 2" for vent and 2 threaded pipe couplings (straight) 2" and 1". Supplied with: Tanker coupling and ventilation cap.</p>	1451

### ACCESSORIES FOR WASTE OIL TANK

Description	Order no.
 <p>Filling funnel complete, with ventilation connection and lockable cover, for Profi-Tank 2000 L</p>	7207
<p>Padlock for above, galvanised</p>	1490
 <p>Dome lid (steel) complete with suction pipe, with pipe couplings, respectively 1 x 2", 1 1/2" and 1". Supplied with: tanker coupling and a blanking cap for each pipe coupling 2", 1 1/2" and 1"...</p>	7332

### ACCESSORIES GENERAL

Description	Order no.
 <p>Electronic overfill prevention, 230 VAC comprises evaluation unit and probe housing protection category IP 54, fitting 1" and 3/4", reduction 2" to 1", probe 500 mm</p>	11452
 <p>Contents gauge Piusi OCIO for oil, 230 V, IP55 An innovative system for management of the liquid level in tanks at atmospheric pressure. Special features: continuous measurement, display of heights, volumes and refill percentages, minimum and maximum level alarms, high accuracy, simple installation, simple software configuration, PC connection possible</p>	7796
 <p>Step, galvanised, step heights 20 cm and 40 cm</p>	3345
 <p>Tank heater type TH 370, 230 V, dia. 44 mm for electric heating of EL grade heating oil and diesel fuel power 0.22 kW, self-regulating, prevents separation of paraffins at low temperatures</p>	8126

# CEMO lubricant trolley PG 4

The practical solution for filling vehicles used on construction sites or in the field.

- capacity 60 L and 100 L
- for transport and independent filling of unused engine, gear and hydraulic oils (no dangerous goods as per ADR)
- polyethylene container with integral hand grip and carry handles
- filler cap with integral vent and breather valve
- outlet connection with isolation valve
- trolley 100 L: 300mm diameter pneumatic tyres, all-terrain
- trolley 60 L: 240mm diameter plastic tyres
- interior baffle
- integral nozzle holder
- trolley 100 L: moulded recesses enabling strapping during transport
- equipped with 12 V, self-priming electric gear pump, 4.5 L/min, max. delivery pressure 5 bar with battery and charger, with oil dispensing nozzle, 3.2 m dispensing hose (100 L), 2.7 m dispensing hose (60 L)



Lubricant trolley 60 L



Lubricant trolley 100 L



Lubricant trolley 100 L with K400 meter as accessory



incl. charger



Electric pump with LiFePO<sub>4</sub> battery

Description	Dimensions cm (l x w x h)	Weight approx. kg	Order no.
60 L with electric pump, LiFePO <sub>4</sub> battery, charger and oil dispensing nozzle	90 x 53 x 38	17	10936
100 L with electric pump, LiFePO <sub>4</sub> battery, charger and oil dispensing nozzle	100 x 59 x 43	22	10751

## ACCESSORIES

Description	Order no.
 <p>Electronic K400 meter, oval gear principle, 1-30 L/min, ½" inner thread, max. 70 bar, suitable for oil metering pistol and more</p>	8574
 <p>Lithium-iron phosphate battery (LiFePO<sub>4</sub>), 12.8 V – 3.3 Ah, as spare battery Pumping volume with one battery charge (depending on viscosity) approx. 90 litre.</p>	10602

# CEMO MOBIL EASY PG 4

## Mobile tank systems for lubricants

The practical solution for filling vehicles with clean engine, gear and hydraulic oils (no dangerous goods as per ADR) used on constructions sites or in the field.



- single-walled container made of polyethylene
- belt guide for tie-down straps
- integral dispensing nozzle holder
- DN 100 filler neck with cap
- vent with pressure relief
- integral forklift pockets
- integral handles
- self-priming, 12 V electric gear pump, 10 L/min, max. delivery pressure 4 bar, 4 m connection cable with crocodile clips
- delivery hose 4 m
- oil dispensing nozzle



Lubricant MOBILE Easy 200 L with 12 V pump and oil dispensing nozzle

Description	Dimensions cm (l x w x h)	Weight approx. kg	Order no.
200 L with pump 12V and oil metering pistol	80 x 60 x 59	31	10752

## ACCESSORIES

Description	Order no.
 <p>Electronic K400 flow meter, oval gear principle, 1-30 L/min, ½" inner thread, max. 70 bar, suitable for oil metering pistol and more</p>	8574
 <p>Lid for Lubricant Mobil Easy 200 L</p>	8963
 <p>Li-Power-Block 13,2 V - 5,5 Ah with charger (see page 41) The battery has the capacity to pump approximately 150 litres of lubricant on a single charge, depending on viscosity.</p>	10750



Li-Power-Block as accessory



## Transfer trolley for oil 130 L PG 4

### The practical solution for filling vehicles and machines in the workshop

- for transport and independent filling of fresh engine, gear and hydraulic oils in the workshop
- totally mobile and cable-free
- 130 L container made of high-quality polyethylene, with integral handles
- low centre of gravity
- filler neck with integral ventilation
- with contents gauge
- integral pump sump allows the container to be emptied almost entirely
- equipped with four steering castors  $\varnothing$  100 mm (two steering castors with rotation and swivel brake)

- integral dispensing nozzle holder
- equipped with self-priming gear pump, 2.5 L/min, max. delivery pressure 4 bar, with battery and charger, with oil metering pistol and 2 m dispensing hose



**NEW**

Filling vehicles and machines in the workshop

Description		Pump dispensing volume	Battery capacity	Max. volume (litres) per battery charge	Dimensions in cm (l x w x h)	Order no.
130 L with pump, battery, charger and oil metering pistol	<b>NEW</b>	6 L/min	4 Ah	120	50 x 75 x 101	11546
130 L without pump and battery	<b>NEW</b>	6 L/min	-	-	50 x 75 x 101	11676

### ACCESSORIES TRANSFER TROLLEYS

① Charger ASC55, 220 - 240 VAC, 3 A, CAS

② Li-Power Battery 18 V / 4,0 Ah CAS



**NEW**

11385

**NEW**

11387

③ Electronic flow meter K400, oval wheel principle, 1 - 30 L/min, 1/2" internal thread, max. 70 bar, suitable for oil metering pistol and more

8574

## Caddy for screenwash or radiator antifreeze PG 4

Antifreeze fluid  
Screenwash

Mobile device for the simple filling of screenwash or radiator antifreeze. Optimal for the workshop or the vehicle fleet. Suitable for concentrate and water mixtures. Mixing can be done directly in the container.

- caddy with 60 L capacity
- scale as content indicator
- markings for common mixing ratios
- crank pump with 0.38 litres per revolution
- delivery valve with lock



Accessory digital flow meter K24

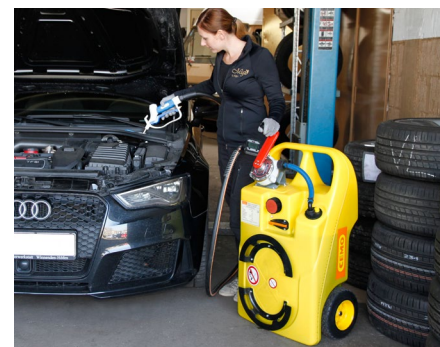

Description	Dimensions cm (l x w x h)	Weight approx. kg	Order no.
60 L caddy or screenwash or radiator antifreeze, with crank pump, 2.9 m delivery hose and manual nozzle	90 x 53 x 38	14	10873

### ACCESSORY

Description	Order no.
Digital flow meter K24 plastic, 6 - 100 L/min, 1" internal thread, 90° elbow for direct attachment to the pump	10274



# TANK SYSTEMS FOR ADBLUE® | DEF





# CEMO tank systems for AdBlue® / DEF (p. 86-105)

AdBlue®



88

## CEMO CUBE 5,000 L

- 5,000 L
- everything fully integrated
- the new dimension of CEMO CUBE-Tanks



91

## CEMO CUBE "OUTDOOR" AND "INDOOR" BASIC AND PREMIUM

- 1,500 L, 2,500 L
- expandable to 5,000 L
- everything packed into a small space

We also offer tanks and systems for co-generation plants and biogas plants. Please feel free to contact us.



97

## CENTRI SP 30 PUMP SYSTEM FOR DRUMS 200 L

- low-cost entry-level solution



## CEMATIC BLUE PUMP SYSTEM FOR IBCS

The classic choice for everyone who has not yet acquired their own larger tank system.



## CEMATIC BLUE PUMP SYSTEM FOR DRUMS 220 L

- complete system
- simple



## BLUETROLL MOBILE

- mobile and adaptable
- refilling where necessary and cleaning up where there is space

98



99

## TROLLEY FOR ADBLUE®

All-terrain due to large wheels and integrated baffle.

- 60 L + 100 L
- no ADR certification is required for transport



101

## BLUE-MOBIL EASY

The practical solution for filling vehicles when used on construction sites or in the field.

- 125 L - 980 L
- no ADR certification is required for transport



104

## TROLLEY CAR PRO

- mobile passenger vehicle filling system in the workshop

# Filling stations for AdBlue®

## BASICS AND REQUIREMENTS FOR FILLING STATIONS FOR ADBLUE®

Aqueous urea solution AUS 32 (trade name AdBlue®, for example) is a non-hazardous chemical substance as defined in the German Ordinance on Hazardous Substances.

AdBlue® must not be exposed to direct sunlight. The optimal storage temperature is between - 5°C and + 20°C.

It freezes at -11°C and should not be stored for longer periods above +30°C, because vaporisation of ammonia increases with temperature and the urea concentration decreases.

All parts in contact with fluids must be made of stainless steel or certified plastics, because the urea solution is highly pure and must correspond to ISO 22241. CEMO tank systems meet this requirement.

AdBlue® is classified as a low hazard to water (water hazard class 1). Consequently, the relevant provisions of the laws pertaining to water and waterways apply. These were summarised by the German Association for Water, Wastewater and Waste (DWA) in technical rule **TRwS 781-2**. It covers the filling of vehicles with aqueous urea solution from stationary storage tanks as well as mobile tanks used at a fixed location in filling stations for vehicles, both for public filling and private filling station.

The capacity constitutes the state of the art and is binding for all operating companies, both for existing tank systems as well as for new systems to be established.

**In all cases, contamination of the light oil separator or the sewer system by AdBlue® must be avoided.**

Thus for filling storage tanks and fueling vehicles a filling area which is impermeable to fluids with an effective range according to TRwS 781: 4.1.2 is required.

### Storage containers

- For volumes greater than 1,000 litres, the tank must be double-walled or a means of retention must be present. Please clarify the requirements which apply to your local water authorities. We will be happy to advise you.
- Storage tanks must be equipped with an certified overfill prevention system.
- Collision protection, for example as kerb, guard rail, large stones or similar.

### Filling of vehicles with AdBlue®

- Nozzles with automatic shut-off must be used.
- The retention capacity of the necessary filling area must constitute 5 min of the maximum pump delivery rate and at least the maximum defined delivery volume with the use of an automatic pump.
- If this retention volume is not present without AdBlue® getting into the light oil separator or sewer system, then the requirement is considered met, only if the locking catch of the nozzle is removed and it is ensured that the dispensing hose cannot be run over.

### Filling the storage tank

- For a filling area in the open, rainwater need not be considered in the calculation of retention volume when the area is covered.
- The necessary retention volume with the use of a dispensing hose safety system amounts to  $R1 = 0.1 \text{ m}^3$ ; for filling using equipment with a safety button which must be held down while filling and an emergency shutoff function  $R1 = 0.9 \text{ m}^3$
- The entire retention capacity present can be filled up to the oil separator if a closure is present at a suitable position before it, which can be closed during the filling of the large tank.

### TIP

- No retention capacity is required if:**
1. **Dispensing hoses are in accordance with the German Technical Regulations for Flammable Liquids (TRbF) 50 Appendix B or Directive 97/23/EC are used and operated in accordance with Bulletin T002 of the Employment Accident Insurance Fund of the Chemical Industry (BG Chemie)**
  2. **Full hose delivery equipment with dry coupling is used**
  3. **An immobiliser is used on the tank vehicle**
  4. **Filling of the storage tanks takes place on a filling area compliant with TRwS 781**
  5. **The dispensing hose cannot be run over (for example, automatic hose reel with spring return without pawl).**

The points listed are abbreviated excerpts from the cited and general regulations in some cases with no guarantee of completeness.



# CEMO CUBE 5,000 L

## Stationary tank systems for AdBlue®

The new CUBE-Tank series is the first generation of filling stations to have been uncompromisingly developed as a complete system from the outset. With the 5,000 L size, CEMO is expanding this concept upwards. Everything has its place and nothing interrupts the filling process. Let us convince you of the advantages of this overall concept.



video  
CUBE-Tank



large access

Hinged lid with 300 mm inspection port.



ergonomically perfect

All components are clearly located at optimal height within the bund.



double protection

Integral 110% bund gives added environmental protection.



wind load protection

Four fixing points on the floor for wind load protection.



easy to lift

Three attachment points around the circumference Ø 20 mm for shackles or hoists for lifting of the empty tank station from above.



# CEMO CUBE 5,000 L for AdBlue® PG 4

## Filling stations for AdBlue®, Complete stations Basic and Premium with general construction inspection Z-40.21-565

- with integrated bund
- hinged lid (Outdoor)
- visual bund alarm
- filling connection with 2" dry coupling
- electronic overfill prevention
- mechanical contents gauge
- pump 230 V, 35 L/min
- automatic nozzle with dispensing nozzle holder
- fitting heater 250 W (Outdoor)
- completely assembled
- all devices wired ready to connect into a terminal box



CUBE-Tank for AdBlue®, Outdoor Premium



CUBE-Tank for AdBlue®, Outdoor Basic

## CUBE-Tank for AdBlue® for connection to an external fuel terminal

Features the same as CUBE-Tank for AdBlue®, however in addition:

- FMT3 meter with pulsed output, 25 pulses per litre
- dispensing nozzle contact
- release relay 230 V
- completely assembled

## CUBE-TANK FOR ADBLUE®, FUEL TERMINAL



Meter FMT 3 with pulse output



Dispensing nozzle switch

Description	Capacity L	External dimensions cm (w x d x h)	Weight approx. kg	Order no.
Indoor Basic DN 19 dispensing hose 6 m	5,000	240 x 230 x 174	185	11140
Indoor Premium meter K24, DN 19 hose reel 8 m	5,000	240 x 230 x 174	200	11141
Outdoor Basic, DN 19 dispensing hose 6 m	5,000	240 x 230 x 180	200	11028
Outdoor Premium, meter K24, DN 19 hose reel 8 m	5,000	240 x 230 x 180	215	11029
Outdoor Premium fuel terminal	5,000	240 x 230 x 180	217	11165
CUBE-Tank for AdBlue® Outdoor storage and extension tank <u>version as per Basic</u> but without pump, dispensing hose, nozzle and nozzle holder. For <u>connection set see Accessories.</u>	5,000	240 x 230 x 180	190	11352

AdBlue® is a registered trademark of the German Automotive Industry Association.

# CEMO CUBE 5,000 L PG 4

## Stationary tank stations for AdBlue®

### CUBE Tank for AdBlue® Outdoor Premium Plus with Tank Management System CMO 20

Specification the same as CUBE Tank for AdBlue® Outdoor Premium, and in addition:

- flow meter with access control and Tank

Data Management System "CMO20" for up to 999 users, incl. 5 user key fobs and one Master Key fob

- access via key or PIN code
- input of kilometre reading/operating hours

### Outdoor Premium Plus 20 SIM\*\*\*

As Outdoor Premium Plus 20, additionally with:

- electronic fill-level indicator
- GPS function
- modem for tank data transmission

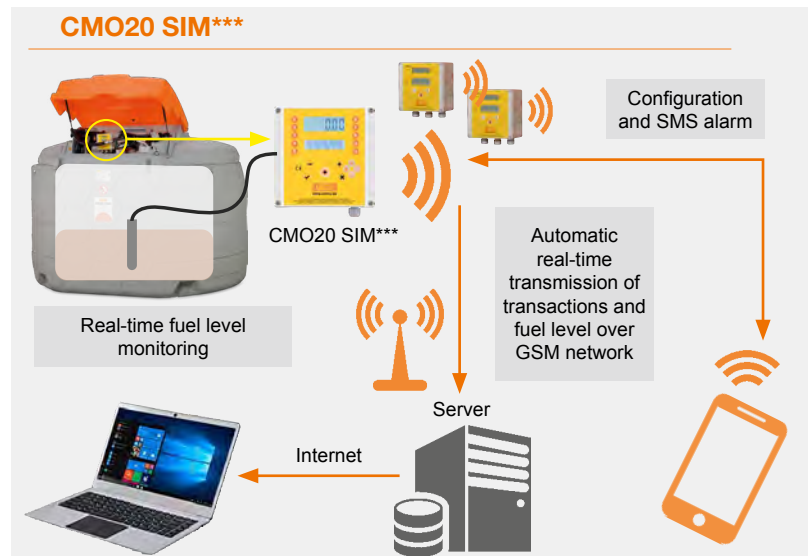







\*\*\* SIM card not included.

## CUBE-TANK FOR ADBLUE® OUTDOOR PREMIUM PLUS AND PLUS SIM

Description	Capacity L	External dimensions cm (w x d x h)	Weight approx. kg	Order no.
Outdoor Premium Plus 20	5,000	240 x 230 x 180	220	11339
Outdoor Premium Plus 20 SIM	5,000	240 x 230 x 180	220	11340

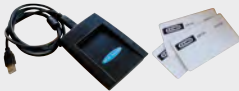
## ACCESSORIES (NOT FITTED)

Description	Order no.
 Connection set between expansion tank and first tank. Consisting of connection pipe, hose, ball valves and connection fittings. Insulation or heating for pipe and hose not included.	11353
 Hose reel with 8 m of EPDM hose, DN 19, including mounting fittings	11168
 Digital flow meter K24 plastic, 6 - 100 L/min, 1" internal thread, 90° elbow for direct attachment to the pump	10274
LED instrument lighting with motion sensor and battery	10378
 Hinged lid blue, with gas struts and mounting fittings	11142
 Tank heater for AdBlue® 230 VAC/435 W, stainless steel, with 6 m connection cable Switching temperatures: Ton (-3) – (-5) °C, Toff (1 - 3) °C, size 700 mm x 47 mm. Suitable for retrofitting at any time. Two or more heaters can be installed for higher output requirements. We recommend insulating the installation surface of the tank system.	10756
 Data transfer set with 3 data transfer cards and USB key reader for wireless data transfer to PC, incl. PC software	10746
 Key fob with 5 user key fobs	10747

# CEMO CUBE for AdBlue® PG 4

## Dispensing station for AdBlue®, Basic and Premium with general construction inspection certification no. Z-40.21-510

- comprising integrated bund
- visual bund alarm
- 2" dry tanker coupling
- electronic overfill sensor
- analogue contents gauge
- 230V pump 35 L/min
- automatic nozzle with integral nozzle holder
- completely assembled
- all devices wired ready to connect into a terminal box

## CUBE-Tank for AdBlue® for connecting to an external fuel terminal

Specification as CUBE-Tank for AdBlue®, however in addition

- FMT 3 meter with pulsed output, 25 pulses per litre
- dispensing nozzle contact
- release relay 230 V
- completely assembled



Integral forklift runners assists with loading and installation.

Moulded hexagonal matrix for integral polymer strength, supported by twin steel bands at the points of greatest load



CUBE-Tank for AdBlue®, 1,500 L, Indoor Premium

Description	Capacity L	External dimensions cm (w x d x h)	Weight approx. kg	Order no.
CUBE-Tank for AdBlue®, Indoor Basic, 6m dispensing hose, without hinged lid	1500	120 x 115 x 174	165	10301
	2500	120 x 180 x 174	220	10302
CUBE-Tank for AdBlue®, Indoor Premium, meter K24, hose reel with 8m dispensing hose	1500	120 x 115 x 180	190	10434
	2500	120 x 180 x 180	250	10435
CUBE-Tank for AdBlue®, Outdoor Basic, 6m dispensing hose, Winter Pack Mid-Europe <sup>1</sup> , with hinged lid	1500	120 x 115 x 180	190	10303
	2500	120 x 180 x 180	250	10304
CUBE-Tank for AdBlue®, Outdoor Premium, meter K24, hose reel with 8m dispensing hose, Winter Pack Mid-Europe <sup>1</sup> , with hinged lid	1500	120 x 115 x 180	205	10305
	2500	120 x 180 x 180	265	10306
<u>CUBE-Tank Extension Indoor:</u> CUBE-Tank for AdBlue® with integrated bund, with visual bund alarm, filling connection with 2" dry tanker coupling, electronic overfill sensor, contents gauge, suction hose with connection kit to first tank, <u>completely assembled</u>	2500	120 x 180 x 180	220	10436
<u>CUBE-Tank Extension Outdoor:</u> CUBE-Tank for AdBlue® with integrated bund, with visual bund alarm, filling connection with 2" dry tanker coupling, electronic overfill sensor, contents gauge, suction hose with connection kit to first tank, Winter Pack Mid-Europe <sup>1</sup> , with hinged lid, <u>completely assembled</u>	2500	120 x 180 x 180	235	10307
CUBE-Tank for AdBlue® Indoor Basic "Tank system"	2500	120 x 180 x 180	222	11036
CUBE-Tank for AdBlue® Outdoor Basic "Tank system"	2500	120 x 180 x 180	252	11037
CUBE-Tank for AdBlue® Outdoor Premium "Tank system"	1500	120 x 115 x 180	206	10466
	2500	120 x 180 x 180	266	11038

<sup>1</sup> Winter Pack Mid-Europe: includes heater 250W for equipment area



**CEMO CUBE** PG 4  
Stationary tank stations for AdBlue®

AdBlue®



CUBE-Tank for AdBlue®,  
1,500 L, Outdoor

CUBE-Tank for AdBlue®,  
1,500 L, Outdoor Premium



CUBE-Tank for AdBlue®, Outdoor Premium



CUBE-Tank for AdBlue®, 1,500 L, Outdoor Basic



CUBE-Tank for AdBlue®,  
heating with thermostat



Sealing brush prevents from cold.



**Accessories see page 95.**

**CUBE-Tank for AdBlue® Outdoor Premium Plus with tank data management system CMT 10**

Design as CUBE-Tank for AdBlue® Outdoor Premium, however

- meter with access control and tank data management system "CMT 10" with up to 250 users
- incl. 5 user keys and 1 master key
- completely assembled



CUBE tank for AdBlue®,  
Outdoor Premium, with meter with access control and "CMT 10" tank data management system as accessory

**CUBE-TANK FOR ADBLUE® OUTDOOR PREMIUM PLUS WITH TANK DATA MANAGEMENT SYSTEM CMT 10**

Description	Capacity L	External dimensions cm (w x d x h)	Weight approx. kg	Order no.
CUBE-Tank for AdBlue® Outdoor Premium Plus, meter with access control and tank data management system "CMT 10", user keys and master key	1500	120 x 115 x 180	206	11030
	2500	120 x 180 x 180	266	10920

AdBlue® is a registered trademark of the German Automotive Industry Association.

# CEMO CUBE for AdBlue® PG 4

AdBlue®



Accessory LED instrument lighting



Accessory hose reel



Accessory:  
Insulating jacket





Accessory heater

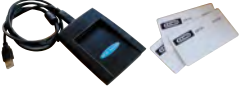

Accessory K24 digital  
flow meter

## ACCESSORIES FOR CUBE-TANK FOR ADBLUE® (NOT ASSEMBLED)

Description	Order no.
Hose reel with 8 m EPDM hose, DN 19	10431
Digital flow meter K24 plastic, 6 - 100 L/min, 1" internal thread, 90° elbow for direct attachment to the pump	10274
LED instrument lighting with motion sensor and battery	10378
Hinged lid blue, complete with gas strut and mounting fittings	10437
Tank heater for AdBlue® 230 VAC/435 W, stainless steel, with 6 m connection cable Switching temperatures: Ton (-3) – (-5) °C, Toff (1 - 3) °C, size 700 mm x 47 mm. Suitable for retrofitting at any time. Two or more heaters can be installed for higher output requirements. We recommend insulating the installation surface of the tank system.	10756
Insulating jacket for CUBE-Tank 1,500 L Grey insulating cover made from UV and weather-resistant PVC tarpaulin with flexible 20 mm insulation, easy installation with Velcro fasteners, no "BLUE to go" logo (individual printing as advertising surface on request)	10954
Insulating jacket for CUBE-Tank 2,500 L	10955
 Data transfer set with 3 data transfer cards and USB key reader for data transfer to PC, incl. PC software	10746
 Key set with 5 user key fobs	10747



### CUBE-fueling system 5,000 L for AdBlue®, comprising:

- CUBE-Tank 2,500 L for AdBlue®, Outdoor Premium (10306)
- Extension Outdoor 2,500 L (10307)

# CEMO Tank stations PG 4

## Stationary tank stations for AdBlue®

With general construction inspection certification no. Z-40.21-241

- PE banded tank "Basic" made of high density polyethylene (HD-PE)
- horizontal bands
- four 2" internally threaded connections
- without accessories



PE banded tank "Basic", without accessory



GRP bund 5,500 L as accessory

### PE BANDED TANK „BASIC” WITHOUT ACCESSORIES

Capacity L (gross)	Dimensions cm (l x w x h)	Weight approx. kg	Order no.
5000	239 x 135 x 198	295	8259

### ACCESSORY

Description	Dimensions cm (l x w x h)	Weight approx. kg	Order no.
GRP bund 5500 L with tank certification no. DIBt: Z-40.12-471	298 x 159 x 134	165	8321

### MOBILE FILLING OF ADBLUE®



Blue-MOBIL Easy, see page 101 to 103





# CEMO filling stations for AdBlue® PG 4

## ACCESSORIES FOR PE BANDED TANK "BASIC"













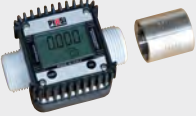

Description	Order no.
 <p>Fixed tanker connection with filling pipe and 2" stainless steel dry coupling, vent with cartridge filter, mesh width 3 µm, replaceable cartridge</p>	8390
 <p>Suction kit, hose 2 m with foot valve, installation thread 2" ET, connection 1" IT</p>	8865
 <p>Pump cabinet for mounting to the wall, electric pump approx. 30 L/min with K24 electronic flow meter, 4 m delivery hose with automatic delivery valve, complete in lockable metal cabinet, with foot valve as accessory, for further accessories, e.g. suction hose, see below</p>	10058

## ACCESSORIES FOR FILLING STATIONS AUS 32, GENERAL

 <p>Dispensing hose EPDM, DN 19, 10 bar, per meter</p>	8248
 <p>Suction hose PVC, DN 19, with plastic spiral, per meter</p>	10757
 <p>Suction hose EPDM, DN 20, with wire spiral, per meter</p>	8387
 <p>Plastic foot valve with connection nozzle DN 19</p>	10661
<p>Accessory hose clip, stainless steel</p>	8249
 <p>ELAFLEX ZVA nozzle for AdBlue® 8.0, with swivel joint 1" ET, with magnetic switch for "ELAFIX" magnetic adapter</p>	8019
 <p>Automatic dispensing nozzle SB325, plastic, with swivel joint, connection nozzle DN 19</p>	10190
 <p>Accessory stainless steel spout with misfilling system and magnetic adaptor for SB325, prevents from misfilling the diesel tank</p>	10452
 <p>Accessory solenoid adapter for AZV AdBlue® with solenoid switch</p>	10192
 <p>Automatic dispensing nozzle with swivel joint, made completely from plastic/stainless steel, connection nozzle DN 19</p>	10422
 <p>Accessory: plastic hand dispenser, polypropylen (PP) body, stainless steel valve, Viton gaskets, connection port DN 19, stainless steel spout 19 mm</p>	8333
 <p>Accessory: plastic manual dispensing nozzle, housing PA6, stainless steel, Viton gaskets, connection nozzle DN 19, outlet 19 mm, with lever lock</p>	11033

# Stationary filling stations for AdBlue®

## ACCESSORIES FOR FILLING STATIONS AUS 32, GENERAL

Description	Order no.
 <p>FMOGne electric flow meter with twin-pulse output, PEEK material, calibratable, 1" male thread both sides, inlet at top, pulse out of open collector, 5 – 24 VDC, 2 x 100 pulses per litre</p>	10049
 <p>Digital turbine meter FMT 3, Type open collector, pulse out 25 p/l, material POM, 5 - 120 L/min, ports 1" BSP male, horizontal flow direction</p>	10451
 <p>K24 electric flow meter, plastic, 6 - 100 L/min, 1" external thread with socket 1" stainless steel</p>	8609
 <p>Flow meter K24 Pulse (87.73 pulses/L), plastic, 5 - 120 L/min, 1" ET, with 1" stainless steel socket</p>	11034
 <p>Plastic swivel joint, 1" external thread, matches K24</p>	8610
 <p>Plastic 90° hose connector, DN 19, matches K24</p>	8611
 <p>Plastic 90° hose connector, 1" external thread on sleeve, DN 19</p>	8612
 <p>DN 19 hosetail with locknut</p>	8731
 <p>90° elbow with locknuts for K24 meter</p>	8732
 <p>Connecting piece, straight with locknuts for K24</p>	8733
 <p>Electronic overfill prevention, 230 VAC comprises evaluation unit and probe housing protection category IP 54, fitting 1" and ¾", reduction 2" to 1", probe 500 mm</p>	11452
 <p>Dry coupling, 2" internal thread, stainless steel, with dust cap</p>	8389
 <p>Pneumatic filling contents gauge, display 0 - 100 %</p>	8020
 <p>Electronic contents gauge OCIO, 230 V, IP 55, 2 relay outputs</p>	10219

## Pump systems for AdBlue® PG 4

### COMPACT FILLING SYSTEMS FOR ADBLUE®

Low-cost entry-level solution

- self-priming as submersible pump on container bottom
- electric pump approx. 25 L/min
- external pump dimensions: length 160 mm, dia. 56 mm
- extremely quiet



Cost-effective entry-level solutions for drums including 12 V submersible pump CENTRI SP 30 and trolley see on page 120.



Bluetroll Mobile 12 V  
Battery not included.

**CENTRI SP 30**  
**EXTREMELY QUIET**

**Description**

Description	Order no.
① Pump set CENTRI SP 30 12 V, with power pack for 230 V, 4 m hose, automatic nozzle	10590
② Bluetroll Mobile 12 V Pump set CENTRI SP 30 with 4 m cable and battery crocodile clips, 4 m hose, automatic nozzle. With transport trolley for drums.	10781

## Drum pump ECO-1 for AdBlue® PG 4

### COMPLETE PUMP SET ECO-1 FOR ADBLUE®

- motor 230 V
- variable dispensing volume, 6 speeds can be selected
- sealless pump unit
- with bung adapter S 70 x 6
- 4 m filler hose



Accessory: digital flow meter K24



Drum pump set ECO-1 with manual nozzle



Drum pump set ECO-1 with automatic nozzle



**Description**

Description	Order no.
① Drum pump set ECO-1 with manual nozzle, max. 80 L/min	10869
② Drum pump set ECO-1 with automatic nozzle, max. 35 L/min	10870

### ACCESSORY

**Description**

Description	Order no.
③ K24 electronic flow meter, with attachment screws and hose connector DN19	10871



# CEMO Cematic Blue pump systems PG 4

## COMPACT FILLING SYSTEM FOR ADBLUE®

AdBlue®

- high-quality diaphragm pump made of plastic, delivery rate approx. 30 L/min supply voltage 230 VAC
- pump self-priming
- dispensing hose 6 m
- automatic nozzle, plastic



① Optional flow meter, see accessories



④ Accessory: long life 3D filter

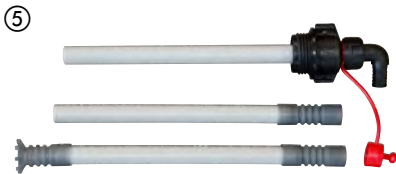

⑤ Accessory: 3-piece suction pipe with coupling AF2



⑥ Accessory: digital flow meter K24



⑦ Accessory: 2-piece suction pipe for IBC and 220 L tanks



⑧ Accessory: coupling SEC



③ Drum not included in the system.

Description	Order no.
① Cematic Blue pump system BASIC auto nozzle, with universal bracket for IBCs as described above, suction hose 1.5 m with SEC coupling	10215
② Cematic Blue pump system for drums 220 L as described above, suction hose 0.5 m with AF2 coupling and adapted suction pipe	10276
③ Bluetroll Mobile, mobile tank system for drums, consisting of a painted chassis, with steering and fixed castors and the Cematic Blue pump system BASIC AZV and adapted suction pipe	10277

### ACCESSORIES FOR CEMATIC PUMP SYSTEMS

Description	Order no.
④ AdBlue® long life 3D filter, replaceable cartridge, suitable for electric pump Cematic Blue and crank pump for AdBlue®	10782
⑤ 3-piece suction pipe with coupling AF2, S 70 x 6 thread, external thread DN 19	10872
⑤ 3-piece suction pipe with coupling AF2, 2" BSP thread, external thread DN 19	11063
⑥ Digital flow meter K24, plastic, 6-100 L/min, 1" internal thread, 90° elbow for direct attachment to the pump	10274
⑦ 2-piece suction pipe for IBC and 220 L tanks (can be shortened), suitable for SEC and CDS coupling, S 56 x 4 thread	10201
⑧ SEC coupling with elbow hoesetail DN 19	10256

# CEMO trolley for AdBlue® PG 4

## Trolley 60 L for AdBlue®

- elegant blue container made from tested polyethylene with integrated handle and carry handles
- large wheels, dia. 240 mm, for simple handling on terrain and over stairs
- integrated sloshing baffle
- low centre of gravity

## Trolley 100 L for AdBlue®

- blue container made from tested polyethylene with integrated handle and carry handles
- wheels, dia. 300, air-filled, all-terrain
- integrated sloshing baffle
- integrated recesses for securing with ratchet tie-downs during transport
- low centre of gravity

## Version with crank pump

- solid construction for professional operation
- housing in stainless steel and technopolymer
- delivery rate 0.38 L per revolution
- with manual dispensing nozzle
- independent of electrical energy

## Version with CENTRI SP 30

- electric submersible pump 12 V, max. 20 A
- delivery rate approx. 25 L/min
- 4 m cable with fuse, switch and crocodile clamps
- always self-priming, extremely quiet
- with lightweight automatic dispensing nozzle in plastic/stainless steel

## Version with CENTRI SP 30 and CAS battery

- totally mobile and cable free, independent of vehicle batteries
- very low self-discharge, no environmentally harmful heavy metals, no memory effect
- high intrinsic safety and integrated protection circuit
- extremely quiet
- incl. charger 220 - 240 VAC, output 18 V - 3 A

**NEW** CAS COMPLESS ALLIANCE SYSTEM



Trolley 60 L for AdBlue® with crank pump



Trolley 60 L for AdBlue® with CENTRI SP30 and CAS battery



**CENTRI SP30  
EXTREMELY  
QUIET**



Trolley 100 L for AdBlue® with CENTRI SP30



Trolley 100 L for AdBlue® with crank pump



Trolley 100 L for AdBlue® with CENTRI SP30 and CAS battery

**NEW**  
CAS COMPLESS ALLIANCE SYSTEM

# CEMO trolley for AdBlue® PG 4

AdBlue®

Description	Dimensions in cm (l x w x h)	Weight approx. kg	Order no.
60 L with crank pump, dispensing hose 2.9 m	90 x 53 x 38	13	11127
60 L with CENTRI SP 30, dispensing hose 2.9 m	90 x 53 x 38	14	11128
100 L with crank pump, dispensing hose 3.4 m	100 x 59 x 43	19	11130
100 L with CENTRI SP 30, dispensing hose 3.7 m	100 x 59 x 43	20	11131

Description		Pump dispensing volume	Battery capacity	Max. volume (litres) per battery charge	Dimensions in cm (l x w x h)	Order no.
<b>Including charger and battery</b>						
						
trolley for AdBlue® 60 L	<b>NEW</b>	25 L/min	2 Ah	300	90 x 53 x 38	11599
trolley for AdBlue® 100 L	<b>NEW</b>	25 L/min	4 Ah	600	100 x 59 x 43	11600
<b>Supplied without charger or battery – use your own CAS battery</b>						
trolley for AdBlue® 60 L	<b>NEW</b>	25 L/min	-	-	90 x 53 x 38	11592
trolley for AdBlue® 100 L	<b>NEW</b>	25 L/min	-	-	100 x 59 x 43	11593



Trolley for Adblue® 60 L

## ACCESSORY

Description	Order no.
 K24 digital flow meter, plastic, 6 - 100 L/min, 1" male thread, with two hose connecting pieces and sleeve for mounting at the hose or to the dispensing nozzle	10595

## ACCESSORIES

① Charger ASC55, 220 - 240 VAC, 3 A, CAS	<b>NEW</b>	11385
② Li-Power battery, 18 V / 2.0 Ah, CAS	<b>NEW</b>	11386
③ Li-Power battery, 18 V / 4.0 Ah, CAS	<b>NEW</b>	11387
④ Li-HD battery, 18 V / 8.0 Ah, CAS	<b>NEW</b>	11388



**Practical and economical:  
one battery for all devices. CAS.**



# CEMO BLUE-MOBIL EASY for AdBlue® PG 4

Highly practical solution for refilling vehicles with Selective Catalytic Reduction (SCR) systems in the field. Urea solution is not classed as hazardous, so no ADR certification needed!

- single-wall container constructed from polyethylene certified for AdBlue®
- moulded recesses for strapping during transport
- integral forklift pockets
- integral carry handles
- self priming 12V chemical pump approx. 30 L/min, 4 m fly leads, with crocodile clips
- 4 m delivery hose DN 19
- automatic nozzle



⑤ Blue-MOBIL Easy 980 L Premium, pump 12 V



⑥ Blue-MOBIL Easy 980 L Premium, pump 230 V



① Blue-MOBIL Easy 125 L

③ Blue-MOBIL Easy 600 L, hinged lid als accessories



① Blue-MOBIL Easy 125 L



② Blue-MOBIL Easy 200 L



④ Blue-MOBIL Easy 980L

## BLUE-MOBIL EASY WITH DIAPHRAGM PUMP CEMATIC BLUE

Description	External dimensions cm (l x w x h)	Weight approx. kg	Order no.	
125 L, with pump 12V	80 x 60 x 45	22	10195	
① 125 L, with pump 24V			10196	
125 L, with pump 12 V, hinged lid			10314	
200 L, with pump 12V	80 x 60 x 59	23	10197	
② 200 L, with pump 24 V			10198	
200 L, with pump 12V, hinged lid			10315	
600 L, with pump 12V, box with crane eyes	116 x 80 x 102	51	10174	
③ 600 L, with pump 24V, box with crane eyes			10175	
600 L, with pump 230V, box with crane eyes			10687	
980 L, with pump 12V, box with crane eyes, hinged lid	127 x 107 x 112	105	10972	
④ 980 L, with pump 24V, box with crane eyes, hinged lid			11164	
980 L, with pump 230V, box with crane eyes, hinged lid			10973	
⑤ 980 L Premium, pump 12 V, box with crane eyes, hinged lid, meter K24, hose reel 8 m, contents gauge			122	11146
⑥ 980 L Premium, pump 230 V, box with crane eyes, hinged lid, meter K24, hose reel 8 m, contents gauge			125	11147

# CEMO BLUE-MOBIL PRO PE 980 L for AdBlue® PG 4

**Robust and professional,  
everything included!**







## Blue-MOBIL PRO PE 980 Premium

- outer container made of 3 mm steel sheet, with high quality coating
- bidirectional forklift pockets and lifting eyes
- lockable lid with gas struts
- inner container 980 L from high quality polyethylene
- Cematic Blue pump, 230 V, 30 L/min
- K24 meter
- auto-rewind hose reel with 8 m of hose, manual nozzle
- contents gauge
- tank heater and equipment heater 230 V



Description	Dimensions in cm (l x w x h)	Weight approx. kg	Order no.
Blue-MOBIL PRO PE 980 Premium	130 x 115 x 130	380	11159

## ACCESSORIES FOR BLUE-MOBIL EASY

Description	Weight approx. kg	Order no.
 Li-Power-Block 12.8 V - 3.3 Ah with charger Sufficient for a dispensing volume of approx. 300 – 389 litres without idling, depending on the pump, charging time approx. 66 min.	0.9	10749
 Li-Power-Block 12.8 V - 5.5 Ah with charger Sufficient for a dispensing volume of approx. 500 – 630 litres without idling, depending on the pump, charging time approx. 110 min.	1.2	10750
 Charger 100 – 240 V, output 14.4 V - 3 A, with crocodile clips	0.5	10759
 Hinged lid for Blue-MOBIL Easy 125 L + 200 L, orange	4	8963
 Hinged lid for Blue-MOBIL Easy 430 L + 600 L, orange (can be hinged on right or left)	13	8833
 Contents gauge Blue-MOBIL Easy 440 L	0.3	11148
 Contents gauge Blue-MOBIL Easy 600 L	1.5	11150
 Contents gauge Blue-MOBIL Easy 980 L	0.4	11149
 Digital flow meter K24, plastic, 6 - 100 L/min, 1" internal thread, 90° elbow for direct attachment to the pump	0.5	10274
 K24 digital flow meter, plastic, 6 - 100 L/min, 1" male thread, with two hose connecting pieces and sleeve for mounting at the hose or to the dispensing nozzle	0.6	10595
 Insulation pack for Blue-MOBIL Easy 125 L + 200 L, including CEMbox 400, grey/orange (order no. 10334), comprising 30 mm insulation panels on the walls and 20 mm on the floor. Space for battery (not included) for supplying power to the pump and the heating pad as needed.	33	10008
 Heating fabric 12 V, thermostatically controlled, approx. 80 W, 50 x 98 cm, IPX 4, cable 2 m with universal connector	0.7	10266
 Coupler cable 1 m, 2-wire, max. 8 A, battery crocodile clips + socket 12 V (SAE J563)	0.3	10267
 Charger ASC55, 220 - 240 VAC, 3 A, CAS <b>NEW</b>	1.3	11385
 Li-Power battery 18 V / 2.0 Ah CAS <b>NEW</b>	0.5	11386
 Li-Power battery 18 V / 4.0 Ah CAS <b>NEW</b>	0.7	11387
 Li-HD battery 18 V / 8.0 Ah CAS <b>NEW</b>	1.0	11388

# CEMO BLUE-MOBIL EASY for AdBlue® PG 4

Specially adapted version of the Mobile Easy suitable for storing and dispensing urea solution AUS32 / DEF / AdBlue®. Highly practical solution for refilling vehicles with Selective Catalytic Reduction (SCR) systems in the field.

Urea solution is not classed as hazardous, so no ADR certification needed!

• angle-wall container constructed from polyethylene certified for AdBlue®

- moulded recesses for strapping during transport
- integral forklift pockets
- integral carry handles
- pump CENTRI SP 30, 12 V approx. 25 L/min, 4 m fly leads, with terminal clamp
- 4 m delivery hose DN 19
- automatic nozzle



CENTRI SP 30  
EXTREMELY  
QUIET



125 L



210 L



440 L

AdBlue®



210 L with CENTRI SP 30



210 L with CENTRI SP 30



CENTRI SP 30 submersible pump, 12 V

**NEW**



## CEMO BLUE-MOBIL EASY for AdBlue®

Description	External dimensions cm (l x w x h)	Weight approx. kg	Order no.
125 L	80 x 60 x 45	20	10593
210 L	78.5 x 59.5 x 68.5	18.8	11143
210 L with hinged lid	78.5 x 59.5 x 68.5	20.5	11144
440 L with hinged lid	118 x 80 x 71	36.3	11145

Description	Pump dispensing volume	Battery capacity	Max. volume (litres) per battery charge	Dimensions in cm (l x w x h)	Order no.
Including charger and battery					
210 L with hinged lid <b>NEW</b>	30 L/min	4 Ah	600	78.5 x 59.5 x 68.5	11602
Supplied without charger or battery – use your own CAS battery					
210 L with hinged lid <b>NEW</b>	30 L/min	-	-	78.5 x 59.5 x 68.5	11595



# Mobile car AdBlue® refilling PG 4

AdBlue®

## Mobile refilling of passenger vehicles for the workshop

The rapidly-increasing number of diesel vehicles with AdBlue® introduces new challenges for workshops in refilling. CEMO presents the ideal solution for your business.

### Trolley Car PRO and Bluetroll Car PRO

- 12V pump
- Elaflex automatic nozzle
- 4-8 L/min, adjustable on the dispensing nozzle; from 2 L/min possible by additional adjustment of bypass and pressure switch at the pump
- digital flow meter K24 (trolley only)
- lithium iron phosphate battery with charger



Trolley Car Pro 60 L



*Drum not included in the scope of delivery.*

Bluetroll Car PRO 200 L



### Bluefill PRO X

- chassis for 200 L and 60 L drums
- 230 V pump with 2 m dispensing hose
- dispensing volume preset
- dispensing volume automatic from 2 L/min to 15 L/min
- coupling for vehicle tank to ISO 22241
- self-cleaning sensor for automatic switch-off
- closed system between drum and vehicle tank, venting back into the drum
- with suction pipe for the drum and coupling type SEC
- the SEC coupling can be used for filling the drum or even connecting to an IBC for direct filling



Coupling with sensor



3-piece suction pipe and coupling AF2



Coupling SEC

Description	Dimensions cm (l x w x h)	Weight approx. kg	Order no.
trolley Car PRO 60L	90 x 53 x 38	16	10773
Bluetroll Car PRO 200L with suction pipe and coupling AF2	82 x 76 x 109	28	10867
Bluefill PRO X* 200 L or 60 L, car filling system with automatic shut-off	80 x 80 x 120	37	10868

## Transfer trolley Blue 130 L PG 4

- for safe, convenient indoor transfer of AdBlue® from the storage area to the vehicle
- totally mobile and cable-free
- 130 L container made of high-quality polyethylene, with integral handles
- low centre of gravity
- integral pump sump allows the container to be emptied almost entirely
- equipped with four swivel castors ø 100 mm (two castors with rotation and swivel brake)
- equipped with submersible pump, approx. 25 L/min, with LiFePO<sub>4</sub> battery, charger, 2 m dispensing hose and automatic nozzle
- suitable for commercial vehicles, construction and agricultural machinery and modern passenger cars.

Not suitable for older passenger cars which can only be filled at a reduced dispensing volume. Please refer to the driver's manual for your vehicle for information about the maximum permissible dispensing volume.



Description	Pump dispensing volume	Battery capacity	Max. volume (litres) per battery charge	Dimensions in cm (l x w x h)	Order no.
130 L, with submersible pump, battery, charger and automatic nozzle	25 L/min	4 Ah	600	50 x 75 x 101	11545
130 L without battery and charger	25 L/min	-	-	50 x 75 x 101	11675

Accessories transfer trolley see page 100

## Transfer trolley Chem 130 L PG 4

- for safe, convenient indoor transfer of liquid chemicals from the storage area to the dispensing point
- totally mobile
- 130 L container made of high-quality polyethylene, with integral handles and nozzle holder
- translucent container features a fill-level scale
- low centre of gravity
- integral pump sump allows the container to be emptied almost entirely
- equipped with four swivel castors 100mm (two castors with rotation and swivel brake)
- The screw cap is positioned in the centre and has an opening with a 2" BSP internal thread, where an electric or manual drum pump with a length of 1,000 mm can be installed. Our drum pumps can be found on pages 128-130.



1,000 mm electric or manual drum pump can be installed (optional accessory)



Description	Dimensions cm (l x w x h)	Weight approx. kg	Order no.
130 L, without pump	50 x 75 x 101	20	11547





# PUMPS





# The right pump for every application



## Diesel-/biodiesel pumps

### Dispensing pumps

Recommended for easy filling of large annual diesel requirements where tank data management is a must

page  
109 - 112

### CUBE pumps

Recommended for an annual diesel consumption between 10,000 and 250,000 litres wherever easy filling is required

113

### Cematic pumps

Recommended for an annual diesel consumption between 1,000 and 40,000 litres wherever easy filling is required without the need for integral tank data management

114 - 118

### CENTRI SP 80

Submersible pump for diesel/biodiesel and heating oil, maintenance free

119

### CENTRI SP 30

Compact submersible electric pump

119 - 120

### CENTRI diesel pump

Electric fuel pumps – low-wearing pumps with a long service life

121

### Hand pumps

For diesel and lubricating oils

122

## Petrol pumps

### ATEX/IECEx-certified pumps

For flammable liquids

123 - 124

## Lubricant pumps

### Viscomat pumps

up to SAE 140

125 - 127

### Hand pumps

For lubricating oils

122

## Chemical pumps

### Drum pumps and pumps for IBCs

For acids, lyes and aggressive chemicals

128 - 129

### Electric pumps Cematic Blue

Electric pumps with stainless steel housing for AUS 32

131

### Hand pumps

Hand pumps for chemicals and urea solution AUS 32

130

## Water pumps

### Petrol-driven pumps

With a dispensing volume up to 500 L/min

120 - 124

All details stated for pressure and delivery volume assume unobstructed suction and dispensing without additional accessories, if not specified refer to effective dispensing volume. AdBlue® is a registered trademark of the German Automotive Industry Association.

# B.SMART PG 4

## Simple and intuitive – the Tank Data Management System with access control via device using Bluetooth.

- Everything under a single part number: fuel dispenser, access code for the web app, and licences for driver/user.
- No monthly or annual costs. No ongoing costs when upgrading your operating system. No separate software required.
- The device sends the fuel receipts to the Cloud. The administrator can track each refuelling operation in real time. It works on any device (PC, tablet, smartphone, etc.) and any operating system (Windows, Linux, iOS, etc).
- Any number of B.SMART systems can be monitored from anywhere.
- Suitable for all devices with iOS or Android operating system. The app is available free of charge from the App Store or Google Play Store.
- Data can be exported from the web app as a PDF or XLSX file.
- Drivers can work in the languages set on their smartphones. Drivers without smartphones can refuel using magnetic keys.



CUBE 70/90 with optional pedestal



Diesel dispensing pump 70/100

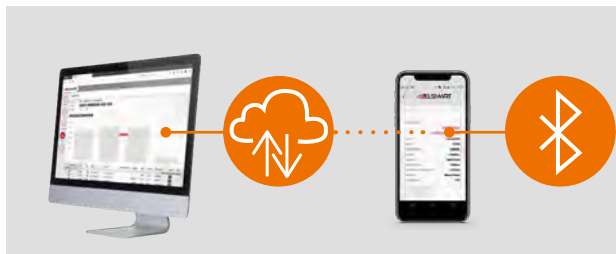

MC-Box-System

Description	Flow rate L/min	Order no.		
		10 user	20 userr	50 user
Diesel dispensing pump 70 B.SMART	70	11289	11290	11291
Diesel dispensing pump 100 B.SMART	90	11292	11293	11294
Dispensing pump for AdBlue® B.SMART	32	11295	11296	11297
MC-Box-System B.SMART	-	11298	11299	11300
MC-Box-System B.SMART for 2 pumps	-	11710	11711	11712
CUBE 70 B.SMART for Diesel	70	11301	11302	11303
CUBE 90 B.SMART or Diesel	90	11304	11305	11306





All devices for 230 V connection. Devices for 12 V or 24 V available on request.



# B.SMART PG 4

## Tank data management system

### ACCESSORIES FOR B.SMART

Description	Order no.
5-User licence pack	11307
15-User licence pack	11308
50-User licence pack	11309
B.SMART ADD-ON tank level indicator, 1-year period	11492
B.SMART ADD-ON tank level indicator, 3-years period	11493
B.SMART ADD-ON tank level indicator, unlimited period	11494
 Pedestal for electric pump CUBE 70 MC 50, black	7888
 Key reader complete with USB interface	10878
 Single user key, yellow	10877
B.Smart ADD-ON Fuel Economy, 1-year period	11703
B.Smart ADD-ON Fuel Economy, 3-years period	11704
B.Smart ADD-ON Fuel Economy, unlimited period	11705
B.Smart ADD-ON tank level + Fuel Economy, 1-year period	11706
B.Smart ADD-ON tank level + Fuel Economy, 3-years period	11707
B.Smart ADD-ON tank level + Fuel Economy, unlimited period	11708
B.Smart Fuel Economy 45 QR-Codes	11709
 Level gauge OCIO 2.0 RS485, 230 V	91528

#### ADD-ON Fill level monitoring

- Management of the tank fill level
- Setting alarms and notifications
- Management of suppliers and prices
- Display of trends and ranges

#### ADD-ON Fuel Economy monitoring

- Fleet management
- Limit consumption per vehicle and/or driver
- Determine average consumption and costs
- Easy entry of external refuelling
- Vehicle recognition via QR code possible

## Diesel dispensers PG 4 for diesel and biodiesel

### Diesel dispensers 70 MC + 100 MC

- rotary vane pump 230 V
- up to 80 users
- diesel dispensing volume can be preset
- option of entering vehicle registration number and mileage
- management of date and time of dispensing
- PIN-code access control is standard
- local recording of the last 255 fuel dispensing events
- optional electronic key access control
- optional data transfer to PC by means of electronic key

- optional data transfer to the PC by means of converter and data transmission cable up to a distance of 1000 m
- equipped with automatic dispensing, design approved in accordance with EN 13012
- 70 MC with passenger car outlet
- 100 MC with truck outlet
- 4 m dispensing hose, DN 25
- filter 30 µm with water separator
- menu language English (for "German" language code, see accessories)

### CUBE 70 MC 50

- set up to 50 users
- menu language German
- suction vacuum approx. 0.3 bar, so not recommended for underground tanks

### Diesel dispensers 70 K44 + 100 K44

- mechanical volumetric litre meter, 4 digit



Diesel dispensers  
70 K44 + 100 K44



Diesel dispensers  
70 MC + 100 MC



Electric pump CUBE 70 MC 50  
with pedestal (accessory)

## DIESEL DISPENSER

Description	Dispensing volume L/min	Dimensions cm (l x w x h)	Weight approx kg	Order no.
Diesel dispenser 70 MC	70	47 x 40 x 144	67	7930
Diesel dispenser 100 MC	90	47 x 40 x 144	75	8563
Diesel dispenser 70 K44	70	47 x 40 x 144	67	7931
Diesel dispenser 100 K44	90	47 x 40 x 144	75	8564
CUBE 70 MC 50	70	46 x 40 x 40	25	7853

We recommend that assembly and commissioning be performed by trained service technicians. We would be delighted to give you details of technicians near you.







Dispensers for **vegetable oil**  
and **AdBlue®** on request.

## Diesel dispensers PG 4 for diesel and biodiesel

### ACCESSORIES

Description	Order no.
 <p>Dispensing hose DN 25 (with 2 x 1" external thread) diesel biodiesel resistant</p>	4 m 7933
	6 m 7934
	8 m 7935
	10 m 7936
 <p>Cartridge filter with water separator, max. 70 L/min, 30 µm, 1"-12 UNF, for dispensing pumps 70 MC/FM/K44 (1 piece) and 100 MC/FM/K44 to model year 10/09 (2 pieces)</p>	10031
 <p>Cartridge filter with water separator, max. 150 L/min, 30 µm, 1½"-16 UNF, for dispensing pumps 100 MC/FM/K44 (1 piece) from model year 11/09</p>	10032

### ACCESSORIES SPECIALLY FOR DISPENSERS MC AND FM

Description	Order no.
 <p>PW-LAN data transmission interface <i>requires PC-software see below</i></p>	11310
 <p>PW-WIFI data transmission interface <i>requires PC-software see below</i></p>	11311
 <p>Converter without PC-software, for data transmission by means of a connection cable to the pump, USB interface, <i>requires PC-software see below</i></p>	10876
 <p>Key set (1 master key, 10 user keys green yellow, key reader with USB interface) for wireless data transfer to the PC, for dispensers beginning year of construction nov. 09 <i>requires PC-software see below</i></p>	10879
 <p>Key reader complete with USB interface</p>	10878
 <p>Master key (1 pc.), red, for data transmission</p>	7826
<p>1 set of user keys (10 pcs.) green, for dispensers until year of constr. oct. 09</p>	7825
 <p>Single user key, yellow</p>	10877
<p>1 set of user keys (10 pcs.) yellow, for dispensers beginning year of constr. nov. 09</p>	8705
<p>"German" language key, for changing the menu language from English to German</p>	8135

## Software SelfService Management 2018

Newly-revised version of the tank data management system for SelfService MC, SelfService FM, MC Box and CUBE MC.

- contemporary control panel and intuitive operation
- simple data import from previous versions
- with drivers for key reader, converter, PW-LAN and PW-WiFi



Description	Order no.
Software SELF SERVICE MANAGEMENT 2018 - USB USB stick with software, also acts as licence key	10865
Software SELF SERVICE MANAGEMENT 2018 - WEB Code for downloading the software, licence check online	10866



## CUBE pumps PG 4 for diesel and biodiesel

### CUBE pumps

- self-priming
- light and robust construction
- simple handling due to low weight
- with anti-siphon device
- 4 m dispensing hose and automatic nozzle is standard
- all pumps are equipped with a meter
- weather-proof housing with integrated nozzle holder and lever switch for automatic pump shut-off
- suction vacuum approx. 0.3 bar, so not recommended for underground tanks



Electric pump CUBE 56 K 33







Electric pump CUBE 70 K 33

### CUBE PUMPS

	Order no.
Pump CUBE 70 MC 50 (picture see page 111) 230 V, approx. 70 L/min (self-priming) with electric flow meter, 50 user codes, automatic nozzle, 4 m dispensing hose installed within a protective box, without suction hose	7853
Pump CUBE 56 K 33, 230 V, approx. 56 L/min (self-priming) with flow meter, automatic nozzle and 4 m dispensing hose DN 19, fitted in a protective housing, without suction hose	7776
Pump CUBE 70 K 33, 230 V, approx. 70 L/min (self-priming) with flow meter, automatic nozzle and 4 m dispensing hose DN 25, fitted in a protective housing, without suction hose	7887

**We recommend that assembly and commissioning be performed by trained service technicians.  
We would be delighted to give you details of technicians near you.**

### ACCESSORIES FOR CUBE PUMPS

Description	Order no.
 Pedestal for electric pump CUBE 70 MC 50, grey	7888
 Wall-mounting bracket	7889
1 set of user keys (10 pcs.) yellow, for dispensers beginning year of constr. Nov. 09	8705
 Quick coupling for barrels 2" x 1"	7781
 PVC suction hose 1.6 m with foot valve and filter (with 1" external thread)	7783
 Dispensing hose DN 25 (with 2 x 1" external thread) diesel biodiesel resistant	4 m 7933 6 m 7934 8 m 7935 10 m 7936

Dispensing hose DN 19 for CUBE 56 pump see page 116.

# CEMATIC pumps PG 4

## for diesel and biodiesel

### Cematic pumps

- self-priming / rotary vane pump
- light and robust construction
- simple handling due to low weight
- with anti-siphon device
- 4 m dispensing hose is standard
- additional hose lengths from 6 to 10 m can be purchased at extra cost
- 2" connector for all commercially available tanks and drums
- connection cable for DC-pumps approx. 4 m long with catch and crocodile clips



All versions include: suction hose, dispensing hose, barrel mounting and angle bracket.

Description	Order no.
 <p>Pump Cematic 56 230 V, approx. 56 L/min (self-priming) with nozzle, 4 m dispensing hose, 1.6 m suction hose with foot valve and 2" quick coupling for barrels</p>	7766
 <p>Pump Cematic 56 AZ 230 V, approx. 56 L/min (self-priming) with automatic nozzle, nozzle holder, 4 m dispensing hose, 1.6 m suction hose with foot valve and 2" quick coupling for barrels</p>	7768
 <p>Pump Cematic 56 K33 AZ 230 V, approx. 56 L/min (self-priming) with flow meter, automatic nozzle, nozzle holder, 4 m dispensing hose, 1.6 m suction hose with foot valve and 2" quick coupling for barrels</p>	7769
 <p>Pump Cematic 3000/12 12 V, approx. 40 L/min (self-priming) with nozzle, 4 m dispensing hose, 1.6 m suction hose with foot valve and 2" quick coupling for barrels</p>	7770
 <p>Pump Cematic 3000/12 K33 AZ 12 V, approx. 40 L/min (self-priming) with K33 flow meter, automatic nozzle, nozzle holder, 4 m dispensing hose, 1.6 m suction hose with foot valve and 2" quick coupling for barrels</p>	7772
 <p>Pump Cematic 3000/24 24 V, approx. 40 L/min (self-priming) with nozzle, 4 m dispensing hose, 1.6 m suction hose with foot valve and 2" quick coupling for barrels</p>	7773
 <p>Pump Cematic 3000/24 AZ 24 V, approx. 40 L/min (self-priming) with automatic nozzle and flow meter, nozzle holder, 4 m dispensing hose, 1.6 m suction hose with foot valve and 2" quick coupling for barrels</p>	7774
 <p>Pump Cematic Duo 24/12 AZ, 24 V, approx. 70 L/min (self-priming only for use with 24 V) with automatic nozzle, nozzle holder, 4 m dispensing hose, 1.6 m suction hose with foot valve and 2" quick coupling for barrels (can also be operated at 12 V, in which case, the pump dispensing volume is 35 L/min.)</p>	8053

# CEMATIC pumps PG 4

## for diesel and biodiesel

### Cematic pumps ① ② ③

- self-priming rotary vane pump
- suction height up to 2.5 m
- robust pump housing of cast steel
- Induction motor 230 V AC, protection category IP 55
- suitable for continuous operation, protected against thermal overload
- integral pressure relief bypass valve
- integral suction filter on Cematic 56 + 72
- 1" internal thread connection on suction and pressure sides

### Cematic pumps DC ④ ⑤ ⑥

- self-priming rotary vane pump
- suction height up to 2 m
- robust pump housing of cast steel
- brush-type DC motor, protection category IP 55
- duty cycle max. 30 min.
- built-in excess pressure bypass valve

### Electric pump Cematic UM ⑧

- 230 V, approx. 56 L/min
- self-priming
- flow meter
- suction hose
- automatic nozzle and nozzle holder
- 4 m dispensing hose
- mounted complete on a bracket that can be hung on the side of the UNI tank

①



230V pump Cematic 56

③



230V pump Cematic 90

⑤

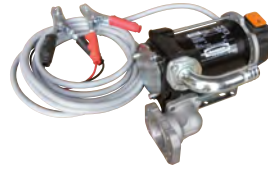

12V/24V pump Cematic 3000/12 + 3000/24

⑦



12V pump Bipump

②



230V pump Cematic 72 + 85

④



24V/12V pump Cematic Duo  
Cematic 56, 12V

⑥



12V Diesel transfer set Cematic 12/40

⑧



230V pump Cematic UM

#### Description

#### Order no.















①	Pump Cematic 56, 230 V, 370 W, dispensing volume approx. 56 L/min, delivery pressure approx. 2 bar	8565
②	Pump Cematic 72, 230 V, 500 W, dispensing volume approx. 72 L/min, delivery pressure approx. 2 bar	8353
③	Pump Cematic 85, 230 V, 700 W, dispensing volume approx. 90 L/min, delivery pressure approx. 2 bar	10764
④	Pump Cematic 90, 230 V, 750 W, dispensing volume approx. 90 L/min, delivery pressure approx. 1,5 bar	8354
⑤	Pump Cematic Duo, 24/12 V, 420 W, approx. 70/35 L/min, delivery pressure max.1.5 bar, 1" internal thread connection on both sides, without cable	10148
⑥	4 m cable with 30 A fuse and crocodile clips, for Cematic Duo 12V/24V	11158
⑦	Pump Cematic 56, 12 V 300 W, max. 56 L/min, delivery pressure max. 1.5 bar, 1" internal thread connection on both sides, without cable	10548
⑧	4 m cable with 40 A fuse and crocodile clips, for Cematic 56 12V	91021
⑨	Pump Cematic 3000/12, 12 V, 280 W, approx. 45 L/min, delivery pressure max.1.5 bar, hosedtail DN 19 suction side, 1" internal thread pressure side	10149
⑩	Pump Cematic 3000/24, 24 V, 280 W, approx. 45 L/min, delivery pressure max.1.5 bar, hosedtail DN 19 suction side, 1" internal thread pressure side	10150
⑪	Diesel transfer set Cematic 12/40	
⑫	In practical plastic case, 12 V pump, 4 m cable with battery pole terminals, dispensing volume approx. 30 L/min, 2 m suction hose with foot filter, 4 m dispensing hose, auto nozzle with swivel joint	10492
⑬	Bipump 12 V, max. 85 L/min 500 W, 1" internal threads , 4 m cable with crocodile clips, with switch	11160
⑭	Electric pump Cematic UM	8162

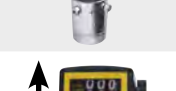

# CEMATIC pumps PG 4





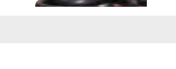

## for diesel and biodiesel

### ACCESSORIES



Description	Order no.	
 Self 3000 fuel pump nozzle (connection 1" internal thread)	7780	
 A 60 automatic dispensing nozzle with hose swivel joint, max. 60 L/min (1" internal thread connection), design approved in accordance with EN 13012	10028	
 A 60 automatic dispensing nozzle with hose swivel joint, max. 60 L/min (1" internal thread connection)	7983	
 Automatic nozzle, swivel joint with DN 19 hosetail	9705	
 A 80 automatic dispensing nozzle, truck outlet, max. 90 L/min, with 1" internal thread hose swivel joint	8355	
 A 80 automatic dispensing nozzle, design approved in accordance with EN 13012, truck outlet, max. 90 L/min, with 1" internal thread hose swivel joint	10026	
 Pump bracket for fitting Cematic pumps on UNI-/MULTI-tank 750 L and 1000 L	7631	
 Quick coupling for drums 2" x 1"(with 1" internal thread)	7781	
 K33 flow meter (connection 2 x 1" internal thread) 3-digit tank display	7779	
 Add-on kit for retrofitting K33 flow meter on Cematic pumps	7984	
 K24 digital flow meter, 10-120 L/min, 5-digit individual delivery display, 6-digit total delivery display, inlet 1" external thread, outlet 1" internal thread	8644	
 Digital flow meter K24 A, aluminium housing, 7 - 120 L/min, 5-digit display, total volume display 6-digit, 1" external thread, 1" internal thread, bi-directional flow	10157	
 1.6 m PVC suction hose with foot valve and filter (with 1" external thread, DN 25)	7783	
 Dispensing hose DN 19 (with 2 x 1" external thread) diesel/biodiesel resistant	4 m	7899
	6 m	7900
	8 m	7901
	10 m	7902
 Dispensing nozzle holder suitable for 7780, 7258, 7983, etc. for installation on the pump foot or on the wall as required	8566	
O-ring for flange connection, with groove on one sides	10027	
Double O-ring for flange connection, with groove on both sides	8357	

## Automatic hose reels PG 4

with spring return. For mounting on the wall, ceiling or floor.









Description	Hose length m	Hose Ø mm	Order no.
<b>Diesel Painted steel plate, with pivot arm</b>			
 Hose reel open, Inlet 1" internal thread, outlet 1" male thread, max. 10 bar, Dimensions 475 x 460 x 246 mm	10	19	10557
Hose reel open, Inlet 1" internal thread, outlet 1" male thread, max. 10 bar, Dimensions 475 x 460 x 246 mm	8	25	8734
Hose reel open, Inlet 1" internal thread, outlet 1" male thread, max. 15 bar, Dimensions 512 x 470 x 322 mm	15	25	11161
<b>Oil Painted steel plate</b>			
 Hose reel closed, with fixed bracket Inlet and outlet ½" male thread, max. 60 bar Dimensions 516 x 491 x 160 mm	12	15	10558
 Hose reel open, with pivot arm Inlet and outlet ½" male thread, max. 60 bar Dimensions 475 x 462 x 150 mm	15	15	10559
<b>AdBlue®, water</b>			
 Hose reel open, painted steel plate Inlet with hosetail 19 mm, outlet open, max. 10 bar Dimensions 475 x 460 x 196 mm	8	19	10560
Hose reel open, painted steel plate Inlet with hosetail 19 mm, outlet open, max. 10 bar Dimensions 475 x 460 x 246 mm	15	19	10561
 Hose reel open, stainless steel Inlet with 0.6 m hose ½" internal thread, outlet ½" male thread, max. 20 bar Dimensions 460 x 450 x 190 mm	10	19	8342
<b>Compressed air</b>			
 Hose reel closed, impact-proof plastic, with swivelling wall bracket, 3/8" ET connections, max. 20 bar, dimensions 500 x 420 x 210 mm	15	15	10883
<b>Cable</b>			
 Cable reel closed, rugged plastic housing, cable oil and water proof, can be locked in any position. With swivel bracket for wall and ceiling installation. Power cable 1.5 m, with Schuko plug.	15	3 x 1.5 mm <sup>2</sup>	10864

### ACCESSORIES FOR HOSE REEL

















Description	Order no.
 Pivotable wall bracket, painted steel plate suitable for order code 8338, 8342	8339
 Pivotable wall bracket, narrow, painted steel plate, suitable for order code 10559, 10560	10563
Pivotable wall bracket, wide, painted steel plate, suitable for order code 10557, 8734, 10561	8735

## Filter for fuels, diesel and biodiesel PG 4

Connection on both sides: 1" internal thread and flange with O-ring groove.

Description	Order no.
 Filter with transparent bowl max. 100 L/min, filter porosity 5 µm, pack contains 2 replaceable elements	10034
 Filter with transparent bowl max. 70 L/min, filter porosity 30 µm, with water separating function, pack contains 2 replaceable elements	10035
 Replacement element, max. 100 L/min, filter porosity 5 µm	10036
 Replacement element, max. 70 L/min, filter porosity 30 µm, with water separating function	10037
 Filter with cartridge 1"-12 UNF, max. 70 L/min, 30 µm, with water separator	8122
 Cartridge filter with water separator, 1"-12 UNF, 30 µm, max. 70 L/min	10031
 Filter with cartridge 1½" - 16 UNF u. 1 ¼" BSP, max. 100 L/min	10783
 Filter with cartridge with water separator, 1½" - 16 UNF, 30 µm, max. 150 L/min	10032
 Oil, diesel and fuel filter with cartridge, 10 µm, max. 60 L/min, max. 12 bar	10784

## Diesel pumps ACCESSORIES PG 4

 Quick-release brass hose coupling, leak-free coupling and uncoupling, 1" internal thread connection	10038
 Rubber suction hose DN 19, RME-resistant, with wire helix, sold by the metre	10039
 Rubber suction hose DN 25, RME-resistant, with wire helix, sold by the metre	10758
 PVC suction hose DN 19, RME-resistant, with plastic helix, sold by the metre	10757
 PVC suction hose DN 25, RME-resistant, with plastic helix, sold by the metre	10040
 Dispensing hose DN 19, PU/PVC, RME-resistant, sold by the meter	11351
 Dispensing hose DN 25, PU/PVC, RME-resistant, sold by the meter	11554
 Hosetail 1" external thread – 19 mm, brass, with O-ring	5522
 Hosetail 1" external thread – 25 mm, brass, with O-ring	10042
 Hose clamp 20 - 32 mm, 9 mm wide, galvanised	7030
 Hose clamp 32 - 50 mm, 9 mm wide, galvanised	10043
 Threaded ferrule compression coupling 1" ET for hose 19/4 mm, reusable	11555
 Threaded ferrule compression coupling 1" ET for hose 25/6 mm, reusable	11556
 Spring-loaded foot valve, brass, with filter, 1" internal thread	10044
 Swivel joint, brass, ¾" external thread, 1" internal thread	11719
 Swivel joint, brass, 1" external thread, 1" internal thread	10155
 Swivel joint ¾" external thread – DN 19 hosetail, nickel-plated brass, Viton seal	11495



## Submersible pump CENTRI SP80 AC PG 4 for diesel/bio diesel and fuel oil

**CEMO submersible pumps: the superior pump principle for your tank system. Simple, fast and safe.**

- Running time limitation: automatic switch-off after a preset time
- Simple start-up: stands on the tank bottom - no suction height
- submersible centrifugal pump Ø 130 mm, suitable for common tanks and IBCs
- electrical supply 230 V/50 Hz, power 800 W
- high flow rate of 80 L/min
- motor thermally protected
- connection 1" internal thread without non-return valve
- connection cable 3 m without plug

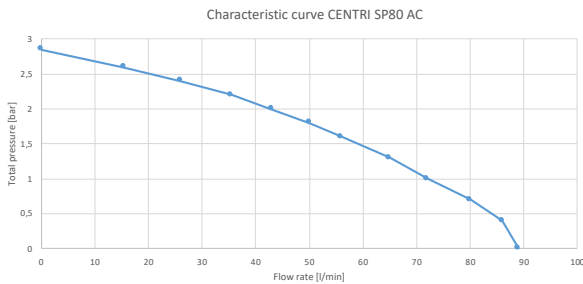

dispensing volume submersible pump CENTRI SP80



Description	Max. dispensing volume in L/min	Max. delivery pressure in bar	Order no.
Submersible pump CENTRI SP 80 AC, 230 V/50 Hz <b>NEW</b>	80	2.8	11644

## Electric pump CENTRI SP 30 PG 4

- low-cost entry-level solution
- low-wear centrifugal pump
- electric motor 12V, max. 20A
- version with power pack for 230V
- self-priming as submersible pump on container bottom
- user-friendly
- compact, lightweight design
- dispensing volume approx. 30L/min with automatic dispensing nozzle
- exterior pump dimensions: length 160 mm, dia. 56 mm
- extremely quiet



Large splash-proof cord switch



### Bunghole adapter in NBR rubber

- suitable for 2" BSP and S 70 x 6
- hose and cable continuous, hence infinitely adjustable to any tank height
- simple to change from drum to drum without screws
- anti-kink sleeve for cable and hose
- integrated vent
- hose clamp for fixing



4 m cable with crocodile clips and blade fuse (versions 10488, 10489, 10490)



Cable connection directly on the 230 V power pack (variants 10590, 10591, 10592)

Diesel/biodiesel  
**AUS32 (AdBlue®)**  
Fresh water  
Antifreeze liquid



Container opening from e. g. 2" BSP and S70x6, Ø 56 mm

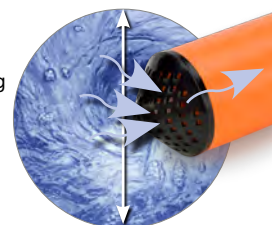

# Electric pump CENTRI SP 30 PG 4

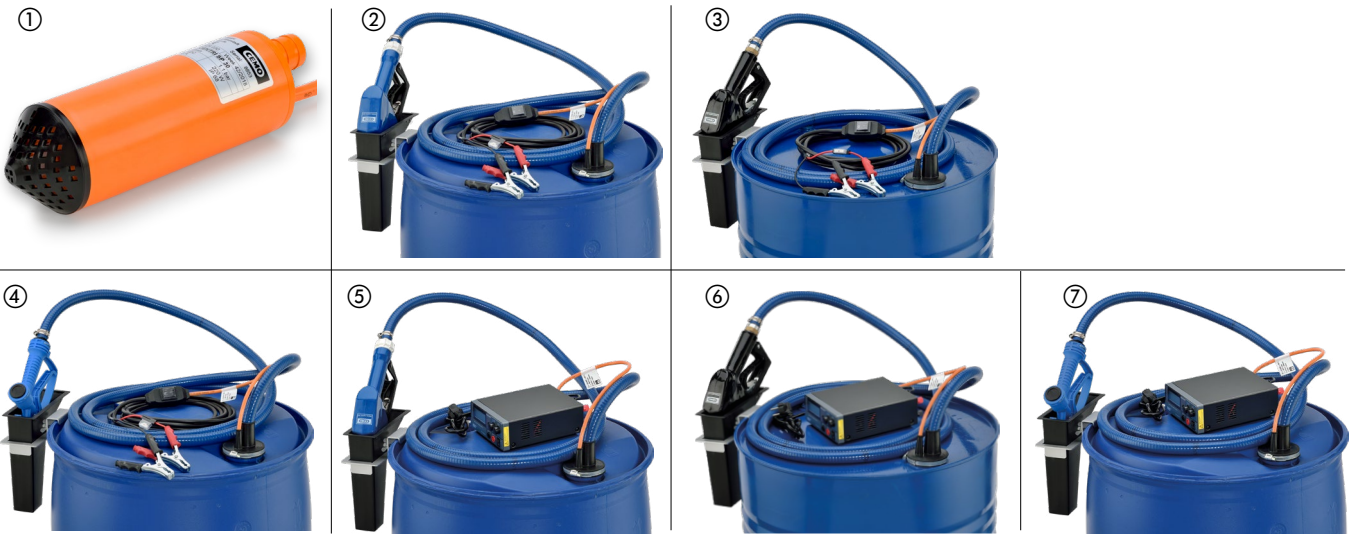









Images with optional nozzle holder accessory

## SUBMERSIBLE PUMP CENTRI SP 30

Description	Order no.
① Submersible pump CENTRI SP30, 12 V, max. 18 A, max. 50 L/min., cable length 1.5 m, hose barb DN 19	91000
<b>PUMP KITS</b>	
② 12 V for AdBlue®, 4 m cable with switch and crocodile clips, 4 m hose, automatic dispensing nozzle	10488
③ 12 V for diesel, 4 m cable with switch and crocodile clips, 4 m hose, automatic dispensing nozzle	10489
④ 12 V for AdBlue® and diesel, 4 m cable with switch and crocodile clips, 4 m hose, dispensing nozzle	10490
⑤ 12 V for AdBlue®, with power pack 230 V, 4 m hose, automatic dispensing nozzle	10590
⑥ 12 V for diesel, with power pack 230 V, 4 m hose, automatic dispensing nozzle	10591
⑦ 12 V for AdBlue® and diesel, with power pack 230 V, 4 m hose, dispensing nozzle	10592

## ACCESSORIES

Description	Order no.
 4 m fly lead with crocodile clips and 25 A fuse	91026
 In-line switch 16 A/250 V, two poles, black plastic	90958
 Li-Power-Block 12.8 V - 3.3 Ah with charger Sufficient for a volume of approx. 300 - 380 litres without idling, depending on the pump, charging time approx. 66 min	10749
 Li-Power-Block 12.8 V - 5.5 Ah with charger Sufficient for a volume of approx. 500 - 630 litres without idling, depending on the pump, charging time approx. 110 min	10750
 Power transformer 230 VAC/13.8 VDC, 20 A, cable 1 m	10491
 For AdBlue®: digital flow meter K24, plastic, 6 - 100 L/min, 1" male thread, with two hose connecting pieces and sleeve for mounting at the hose or to the dispensing nozzle	10595
 Trolley for steel and plastic drums 200 L, 2 steering castors and 2 fixed castors, painted steel tube frame, with holder for dispensing nozzle, hose and cable	10607
 Dispensing nozzle holster for drums complete with clamping screws and drip container	11044

AdBlue® is a registered trademark of the German Automotive Industry Association (VDA).

## Diesel pump CENTRI PG 4 non self-priming

- light and robust construction
- also for continuous operation
- simple handling due to low weight
- 2" connector and M 64 x 4 for all commercially available tanks and drums
- suction hose with foot filter
- integrated hand pump for priming

Diesel/biodiesel  
Antifreeze liquid  
Windshield cleaner





Submersible pump CENTRI 230 V



Submersible pump CENTRI 12 V  
with accessory meter K24

### CENTRI PUMP (EFFECTIVE OUTPUT)

Description	Order no.
 <p>Pump CENTRI, 12 V, approx. 30 L/min effective dispensing volume, 4 m connecting cable with terminals, 6 m hose, dispensing nozzle</p>	8640
 <p>Pump CENTRI, 12 V, approx. 25 L/min effective dispensing volume, 4 m connecting cable with terminals, 6 m hose, automatic dispensing nozzle</p>	8641
 <p>Pump CENTRI, 230 V, approx. 35 L/min effective dispensing volume, 4 m connecting cable, 6 m hose, dispensing nozzle</p>	8638
 <p>Pump CENTRI, 230 V, approx. 30 L/min effective dispensing volume, 4 m connecting cable, 6 m hose, automatic dispensing nozzle</p>	8639
 <p>K24 digital flow meter can be calibrated, measuring range 10 - 120 L/min, 5-digit display, 6-digit total delivery display, inlet 1" external thread, outlet 1" internal thread, with 1" steel coupling</p>	8644
 <p>Dispensing hose for pump CENTRI, DN 19 other sizes available, price is per meter of hose (The standard hose is still included in the package)</p>	11351



# Hand pumps for diesel and lubricants PG 4

- robust construction
- no energy source required
- low-cost

- 2" connector
- suction tube can be shortened as required

Diesel/biodiesel  
Lubricants  
Windshield cleaner  
Fuels

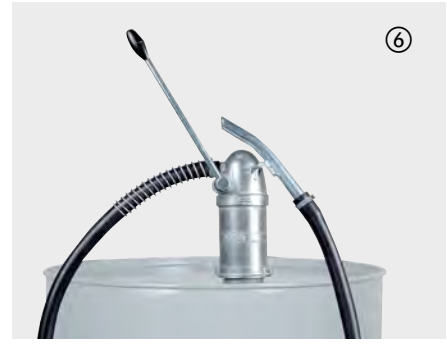
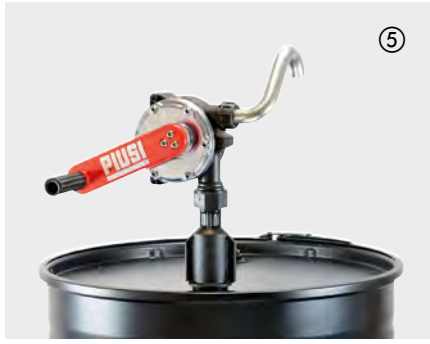

Description	Order no.
<p>① Hand pump with 1.5 m discharge hose with outlet spout DN 19, suction pipe 1450 mm Pumping media: oil up to SAE 50, fuels, undiluted antifreeze, low viscosity mineral oils, heating oil EL/L, diesel, petroleum, biodiesel Dispensing volume: 0.25 L/stroke</p>	1452
<p>② Steel drum-pump with spout for drums 60/200/220 L, Telescopic suction pipe 480-900 mm Pumping media: oil up to SAE 90, self-lubricating, non-abrasive media, undiluted antifreeze, heating oil, diesel, petroleum Dispensing volume: 0.3 L/stroke</p>	7892
<p>③ Hand pump with curved spout and anti-drip nozzle for filling measuring cups, measuring buckets, canisters for drums 60/200/220 L, suction tube 840 mm, quick coupling for drums M 64 x 4 and 2" thread Pumping media: oil up to SAE 90, self-lubricating, non-abrasive media Dispensing volume: approx. 0.25 L/stroke</p>	8577
<p>④ Aluminum rotary pump with curved spout 25 mm, for drums 60/200/220 L, threepart suction pipe 950 mm Pumping media: oil up to SAE 90, self-lubricating, non-abrasive media, undiluted antifreeze, heating oil, diesel, petroleum Dispensing volume: approx. 0.25 L/stroke</p>	10010
<p>⑤ Aluminum rotary pump with curved spout 25 mm, for drums 60/200 L, three-part suction pipe 950 mm Pumping media: oil up to SAE 90, self-lubricating, non-aggressive media, heating oil, diesel, petroleum Dispensing volume: approx. 0.25 L/stroke</p>	11162
<p>⑥ Hand pump with 1.5 m with conductive discharge hose with dispensing spout DN 19, telescopic suction pipe 470-925 mm Pumping media: fuels, undiluted antifreeze, low viscosity mineral oils, eating oil EL/L, diesel, petroleum, biodiesel Dispensing volume: 0.25 L/stroke</p>	<b>NEW</b> 11685

## ACCESSORY FOR ALUMINUM CRANK PUMP

Description	Order no.
 <p>Hose package 2 m, DN 25, with manual nozzle and pipe clamp, compatible with crank pump 10010</p>	10011

## Petrol pumps PG 4 for fuels

### ATEX/IECEx-certified pump Cematic 50 EX for flammable liquids

Complete set consisting of:

- pump 230 V, max. 50 L/min, with dispensing nozzle holder
- 2" drum adapter with coarse filter and check valve
- telescopic suction pipe max. 1100 mm
- cartridge filter 30 µm with water separating function
- 4 m dispensing hose, DN 19
- automatic dispensing nozzle with swivel joint

No connector cable is supplied with the pump. The electrical connection must be made by an expert technician after a risk assessment has been made.

**Petrol 2-stroke mixture  
Avgas | Kerosene**



Electric pump Cematic 230/50 EX, flow meter available as accessory

Electric pump Cematic 230/50 EX

## Petrol pump Cematic 12/25 EX PG 4 for flammable liquids

- vane pump, 12 V, max. 25 L/min
- suction and pressure connection 3/4" internal thread
- motor thermally protected

- Ex dbh II A T4 Gb
- dry self-priming, max. 2 m
- 5 m cable with crocodile clips and cable switch



**NEW**

### ATEX/CE-certified pump Cematic 12/30 EX for flammable liquids

- pump 12 V, approx. 30 L/min
- suction and pressure connection can be mounted on side or top
- compact design with carry handle
- thermally protected
- dry, self-priming, max. 1.5 m



Electric pump Cematic 12/30 EX













Petrol transfer set Cematic 12/30 EX in practical plastic case

## PETROL PUMPS CEMATIC EX

Description	Dispensing volume L/min	Pressure (max) in bar	Order no.	
Pump Cematic 230/50 EX, complete. ATEX, 230 V, filter, 4 m dispensing hose, automatic dispensing nozzle	40	1.1	10249	
Pump Cematic 12/30 EX, 12 V, 14 A, 220 W, 4.1 m cable with crocodile clips and earthing cable with crocodile clips, connection of both sides 3/4"	30	1.1	10647	
Petrol transfer set Cematic 12/30 EX In practical plastic case, 12 V pump, 4.1 m cable with battery pole terminals and earthing terminal, dispensing volume approx. 25 L/min, 2 m suction hose with foot filter, 4 m dispensing hose, manual nozzle with swivel joint	25	1.1	10730	
Cematic 12/25 EX, 12V	<b>NEW</b>	25	0.7	11645

# Petrol pumps PG 4

## ACCESSORIES FOR PETROL PUMPS CEMATIC EX

Description	Order no.
 K33 flow meter, upward flow, 20 - 120 L/min, ATEX	10236
 Retrofit kit for K33 ATEX flow meter, on Cematic 50 EX, Viton O-rings, flange	10410
 Digital flow meter K24 A ATEX/IECEX; II 2 G Ex ia IIB T4 Gb, aluminum housing, 7 - 120 L/min, 5-digit display, 6-digit total quantity display, 1" outer thread, 1" inner thread	10411
 Manual dispensing valve for fuels, outlet diameter 20 mm, with swivel joint 1" IT	90506
 Automatic nozzle for petrol, EN13012, ATEX, with swivel joint 1" internal thread	10142
 4 m dispensing hose, DN 19, 1" external thread, electrically conductive, antistatic	10263
LC-Mix fuel hose, dia. = 19 mm, electrically conductive R < 10 MOhm	10731
 Cable gland 1/2" NPT for cable 7 - 12 mm, to Cematic 50 EX	10264
Connector cable, 3 x 2.5 mm <sup>2</sup> , sold by the meter	10265
 Reducer 3/4" external thread x 1" internal thread	10659
Suction hose 3/4", conductive, sold by the meter	10660
 Plastic foot filter, hose connector 3/4"	10661
 Automatic rewind hose reel, open, for petrol, with swivel bracket/ Inlet 1" internal thread, outlet 1" external thread, max. 15 bar, hose 10m DN19 antistatic, dimensions 495x460x246 mm	11041
 Automatic rewind cable reel, with 16 m earth cable 8 mm <sup>2</sup> green/yellow, earthing clamp, feeder cable 1 m with open end	11042

# Motorised pumps with petrol engine PG 8

Water

### Motorised pump 500 L/min with Honda petrol engine

- pump permanently installed
- 2" suction and pressure port
- DN 50 hose connections
- suction strainer
- max. 3 bar

### Motorised pump with Honda petrol engine

- dispensing volume approx. 130 L/min
- pump capacity up to 3.5 bar
- 1" suction and pressure port
- DN 25 hose connections
- suction strainer



Motorised pump 500 L/min with Honda petrol engine



Motorised pump 130 L/min with Honda petrol engine

Description	Dimensions cm (l x w x h)	Order no.
① Motorised pump with Honda petrol engine, dispensing volume approx. 500 L/min	47 x 35 x 39	8337
② Motorised pump with Honda petrol engine, dispensing volume approx. 130 L/min	33 x 25 x 40	8348



# Lubricant pumps PG 4

Lubricants  
Vegetable oil

## Lubricant pump

### Viscomat 70 and Viscomat 90

- rotary vane pump, thus high delivery volume flow at high pressure
- die cast aluminum pump body
- sintered steel rotor with resin vanes
- seal on the rotary shaft with access from the pump side
- bypass line integrated into the pump body
- suitable for oils up to 500 cSt, corresponding to approx. SAE 90 at 20 °C
- also suitable for vegetable oils e.g. cold pressed rape seed oil









Lubricant pump Viscomat 70 + 90

## LUBRICANT AND VEGETABLE OIL PUMP VISCOMAT 70 AND VISCOMAT 90

Description	Dispensing volume L/min	Pressure (max) in bar	Order no.
Lubricant pump Viscomat 70, 230 V, self-priming, 750 W, 1" internal thread connection on both sides, without accessories	25	6	8727
① Viscomat 90, 230 V, self-priming, 1600 W, 2 m cable with connector, fixed bypass, 1" internal thread connection on both sides, without accessories	50	5	8070
Viscomat 90, 400 V, self-priming 2000 W, connection socket, adjustable bypass, 1" internal thread connection on both sides, without accessories	50	5	7985
Lubricant pump Viscomat 70, 230 V, self-priming, with nozzle, 4 m pressure hose, 1.6 m suction hose 1" with foot valve and quick coupling for drums	25	6	7928
② Lubricant pump Viscomat 70 K33, 230 V, self-priming, with nozzle, flow meter K33, 4 m pressure hose, 1.6 m suction hose 1", with foot valve, quick coupling for drums	25	6	7929

## ACCESSORIES FOR VISCOMAT 70 + VISCOMAT 90

Description	Order no.	
 Self 3000 nozzle (connection 1" internal thread)	7780	
 Automatic dispensing nozzle for vegetable oils with hose swivel joint, 1" internal thread connection, automatic shutoff for plant oil up to + 5 °C oil temperature	8349	
 Quick coupling for drums 2" x 1"(with 1" internal thread)	7781	
 1.6 m PVC suction hose with foot valve and filter, DN 19, 1" external thread	7783	
 Mechanical flow meter K33 Oil, 20-120 L/min, 3-digit display, 1" internal thread on both sides	8728	
 K600/3 electronic flow meter for oil, oval wheel principle, 6-60 L/min, 3/4" internal thread with flange	10430	
 DN 25 dispensing hose (with 2 x 1" external thread)	4 m	7933
	6 m	7934
	8 m	7935
	10 m	7936

## Lubricant pumps PG 4

### Lubricant pump Viscomat 200/2

- gear pump design, thus high dispensing volume at high pressures, no pulsation, uniform flow
- die cast aluminum pump body
- sintered steel gears, with a specially a designed internal profile
- mechanical seal on the engine shaft, accessible from the pump side
- bypass line integrated into the pump body
- suitable for oils up to 2000 cSt, corresponding to approx. SAE 140 at 20 °C

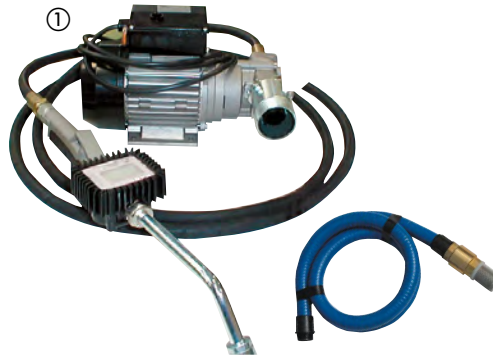

The pump principle:  
gear pump design

### Lubricant pump Visco-Flowmat 200/2

- like Viscomat 200/2, but with pressure switch
- pump switches on automatically when the nozzle is opened
- after delivery the pump continues to run for a few seconds to refill. Afterward it shuts off automatically.

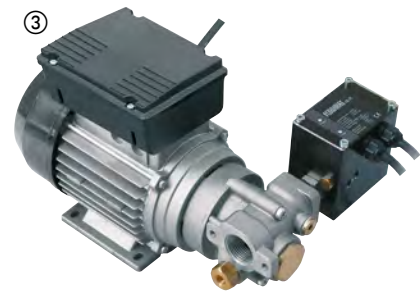

## LUBRICANT PUMPS VISCOMAT 200/2 AND VISCO-FLOWMAT

Description	Dispensing volume L/min	Pressure (max) / bar	Order no.
Lubricant pump Viscomat 200/2, 230 V, self-priming, with nozzle, 4 m pressure hose 1/2", 1.6 m suction hose 1" with foot valve and quick coupling for drums	9	12	7896
① Lubricant pump Viscomat 200/2 K400, 230 V, self-priming, with nozzle, flow meter K400, 4 m pressure hose 1/2", 1.6 m suction hose 1", with foot valve and quick coupling for drums	9	12	7897
② Lubricant pump Viscomat 200/2 230 V, 800 W, 1" internal thread connection on both sides, without accessories	9	12	8571
③ Lubricant pump Visco-Flowmat 200/2 with pressure switch, 230 V, 800 W, 1" internal thread connection on both sides, without accessories	9	12	8572

## Compressed air diaphragm pump PG 4

- max. 60 L/min
- self-priming
- aluminum housing and motor, NBR membrane
- inlet 3/4" internal thread, outlet 1/2" internal thread
- temperature range -20 °C to +90 °C (or briefly +120 °C)
- particles up to 1.5 mm permissible
- max. 8 bar, air consumption 600 L/min
- explosion-proof (equipotential bonding on site)
- accessories, other versions and sizes on request











Waste oil  
Lubricants  
Antifreeze liquid  
Windshield cleaner  
Dirty water

Description	Order no.
Compressed air diaphragm pump, max. 60 L/min	10176

# Lubricant pumps PG 4

## ACCESSORIES FOR LUBRICANT PUMPS VISCOMAT 200/2, VISCO-FLOWMAT AND VISCOAIR

Description	Order no.
 <p>Pressure hose ½" for oil, 2 m, both ends ½" inner thread, with union nuts</p> <p>Pressure hose ½" for oil, 4 m, both ends ½" outer thread</p> <p>Pressure hose ½" for oil, 6 m, one end ½" external thread, other end union nut and ½" double male connector</p> <p>Pressure hose ½" for oil, 10 m, one end ½" external thread, other end union nut and ½" double male connector</p>	<p>10697</p> <p>8608</p> <p>8351</p> <p>8352</p>
 <p>Quick coupling for drums 2" x 1" (with 1" internal thread)</p>	<p>7781</p>
 <p>1.6 m PVC suction hose with foot valve and filter, DN 19, 1" external thread</p>	<p>7783</p>
 <p>Oil dispensing nozzle with ½" swivel joint, fixed outlet with anti-drip nozzle. The K400 meter can be integrated between the handle and outlet.</p>	<p>8573</p>
 <p>Electronic K400 meter, oval wheel principle, 1-30 L/min, ½" inner thread, max. 70 bar, fits equipment including nozzle 8573</p>	<p>8574</p>
 <p>Oil dispensing nozzle K500, with electronic meter, ½" inner thread connection with swivel joint, 2-fold adjustable angle outlet with anti-drip nozzle, 1-30 L/min, max. 70 bar, with quantity pre-setting from 0.1 - 99.9 l. When the preset quantity is reached, the nozzle shuts off automatically.</p>	<p>8576</p>
 <p>Steel telescopic suction pipe, 1" male thread max. 1,100 mm</p>	<p>10748</p>
 <p>Suction pipe and hose set for drums 200 L, incl. wall bracket</p>	<p>10698</p>
 <p>Nozzle holster with drip tray</p>	<p>10696</p>



# Electric drum and IBC pumps PG 4

## for liquid chemicals

### Complete pump sets for your liquid chemicals

- motor, 230 VAC
- ex-rated version available
- sealless pump unit with sturdy 8 mm driveshaft without guide tube
- robust, no dead space, easy to clean
- brief running on empty possible
- quick-lock coupling for super-fast connection with robust gear coupling, insensitive to soiling and aggressive environments
- contained in each set: PP drum adapter, 2" outer thread and wall bracket for storage



① Basic set, for occasional use, can be used for diluted acids and lyes



② Allround set, for regular use, can be used for concentrated acids and lyes



③ Chemical set, for professional use, can be used for aggressive liquids



④ Ex-klusiv set, can be used for solvents and highly flammable liquids



Wall bracket



Drum adapter made from PP, 2" outer thread

## ELECTRIC DRUM AND IBC PUMPS

Description / kit includes	Tech. data, maximum values				for drum, immersion depth 1000 mm	for IBC, immersion depth 1200 mm
	Dispensing volume L/min	Pressure bar	Density kg/L	Viscosity mPas	Order no.	Order no.
① Basic set consisting of: Motor p310-A-230, 520 W, pump unit DL-PP-A-Niro, 2 m PVC hose reinforced DN19, dispensing nozzle PP/FPM/Niro	100	0.6	1.3	300	10438	10442
② Allround set consisting of: Motor p400-A-230, 850 W, pump unit DL-PP-R-HC, 2 m PVC hose reinforced DN25, dispensing nozzle PP/FPM/HC DN25	100	2.0	1.8	700	10439	10443
③ Chemical set consisting of: Motor p400-A-230, 850 W, pump unit DL-PVDF-A-HC, 2 m hose universal chemical DN25, dispensing nozzle PVDF/ FEP 1 1/4"	110	0.8	2.0	800	10440	10444
④ Ex-clusive set consisting of: Motor EX700, 700 W, pump unit Niro-A, 2 m solvent hose DN25, hose connector MS 1 1/4", dispensing nozzle MS/PTFE, earth cable	110	0.7	1.8	600	10441	10445

# Electric drum and IBC pumps PG 4

## for liquid chemicals

Chemicals  
AUS32 (AdBlue®)





### Complete pump set ECO-1 for liquid chemicals

- motor 230 V
- six speed settings
- sealless pump unit
- easy to clean
- brief running on empty possible
- quick-lock coupling
- with S70x6 adapters in set for drums
- with 2" BSP adapter in set for IBCs



Description / kit includes	Tech. data, maximum values				for drum, immersion depth 1000 mm	for IBC, immersion depth 1200 mm
	Dispensing volume L/min	Press bar	Density kg/L	Viskosity mPas	Order no.	Order no.
ECO-1 set, consisting of: Motor 230 V, 450 W; pump unit PP, shaft A2, seal Viton; 2 m PVC hose DN 25, dispensing nozzle PP/FPM/A2	140	1.0	1.8	200	10486	10487

### ACCESSORIES FOR ELECTRIC DRUM AND IBC PUMPS

Description	Order no.
 Digital meter FMT 3 Material PP, 5 - 120 L/min, both side 1" outer thread	10450
 Installation kit (except ECO-1) for meter with 1" outer thread, PP	10446
 Screw lid DN 150 for IBC, with 2" inner thread, TPE seal	10447
 Threaded adapter of 2" fine (I) to 2" Mauser rough (A) S70 x 6	10448

The following table shows a number of typical liquids and their matching pump set.

Liquid	ECO-1-Set	Basis set	Allround set	Chemical set	Ex-klusiv set
Acetone					x
AdBlue®	x	x	x	x	
Battery acid	x	x	x	x	x
Formic acid	x	x	x	x	x
Ammonia water	x	x	x	x	x
Petrol					x
Bleaching lye (sodium hypochlorite)				x	
Chlorine/chlorinated water				x	
Iron III chloride			x	x	
Acetic acid		x	x	x	
Ethanol					x
Ethyl acetate					x
Liquid fertilisers	x	x	x	x	
Anti-free agent (Antifrogen)	x	x	x	x	
Anti-free for radiators (ethylene glycol)	x	x	x	x	x
Cooling lubricants				x	x
Milking machine cleaner, alkali				x	
Milking machine cleaner, acidic	x	x	x	x	
Methanol					x
Caustic soda/sodium hydroxide	x	x	x	x	
Nitrocellulose thinner					x
Propionic acid				x	
Nitric acid		x	x	x	
Hydrochloric acid			x	x	
Foaming agent		x	x	x	x
Window cleaner	x	x	x	x	x
Sulphuric acid				x	
Turpentine					x
Water, (distilled/DI)	x	x	x		

Information on chemical resistance applies to a room temperature of 20°C.  
A verification must be performed at much higher temperatures. At high concentrations, we recommend the use of the higher quality pump sets.

**Can't find your liquid, or aren't sure?**  
Then call representative responsible for your area  
([www.cemo-group.com/representation/international](http://www.cemo-group.com/representation/international)).  
We'd be pleased to assist.

# Hand pumps for chemicals PG 4

## for chemicals

Please read the datasheet for the chemical resistance of the medium to be conveyed, and decide for yourself on the basis of our material specification list!

### Hand pumps for chemicals

- material: plastic, polypropylene and polyethylene
- food-safe
- double-action
- outlet tubes suitable for connecting a hose DN 25
- suitable for propionic acids, molasses, detergent, lubricants, AdBlue®, liquid fertilisers, liquid feeds, pesticides, etc.
- not suitable for highly flammable substances and strong solvents



Chemicals  
AUS32 (AdBlue®)

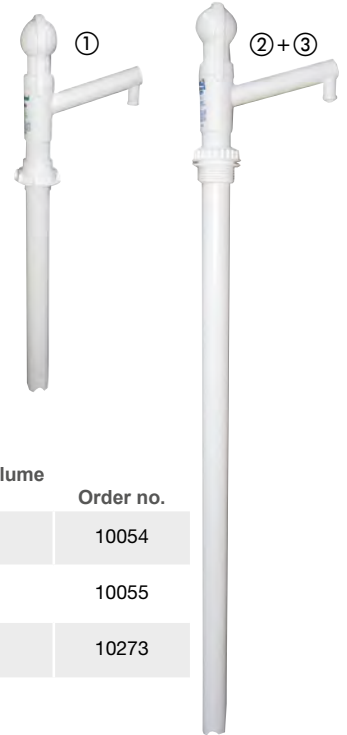

## HAND PUMPS FOR CHEMICALS



Description	Dispensing volume L/stroke	Order no.
① Hand pump for canisters up to 30 L, inclusive of adapter C57 and C63, tube diameter 41 mm, max. immersion depth 420 mm	0.16	10054
② Hand pump for drums up to 220 L, inclusive of adapter S70x6, S56x4 and 2" BSP, tube diameter 41 mm, max. immersion depth 930 mm	0.4	10055
③ Hand pump for IBC 1000 l, inclusive of adapter S56x4 and 2" BSP, tube diameter 41 mm, max. immersion depth 1185 mm, output connection 20 mm	0.4	10273

### Rotary hand pump for AUS 32 (AdBlue®)

- solid construction for professional operation
- housing in stainless steel and technopolymer
- drum adapter with connection thread S56x4
- multi-part suction pipe 1 m, can be shortened as required
- PVC dispensing hose 3 m
- stainless steel outlet pipe 19 mm with protective cap



## ROTARY HAND PUMP FOR AUS32 (ADBLUE®), ANTI-FREEZE, WATER

Description	Dispensing volume L/stroke	Order no.
④ Crank pump for AdBlue® with PVC hose 3 m	0.38	10517
⑤ Crank pump for AdBlue® with PVC hose 3 m, mounting plate for IBC suction hose 1.5 m. For accessories see page 100	38	11163
 Accessory: plastic manual dispensing nozzle, with lever lock, polypropylene (PP) body, stainless steel valve, Viton gaskets, connection hosetail DN 19, stainless steel spout 19 mm	max. 80	8333
 Accessory: plastic manual dispensing nozzle, housing PA6, stainless steel, Viton gaskets, connection nozzle DN 19, outlet 19 mm, with lever lock	max. 80	11033

AdBlue® is a registered trademark of the German Automotive Industry Association (VDA).



## Pumps PG 4 for chemicals

### Electric pump Cematic Blue

- for AUS 32 (AdBlue®), antifreeze fluid and windshield cleaner with flash point > 55 °C
- self-priming plastic diaphragm pump
- 1" external thread connection on both sides incl. DN 19 hose connecting pieces with union nut
- OFF/ON switch
- can be installed in any orientation



AUS32 (AdBlue®)  
Antifreeze fluid  
Windshield cleaner  
Water





①  
Pump  
Cematic Blue 230 V

②  
Pump  
Cematic Blue 12 V + 24 V

### ELECTRIC PUMPS CEMATIC BLUE

Description	Dispensing volume L/min	Pressure (max) in bar	Order no.
① Cematic Blue pump 230V self-priming plastic diaphragm pump, 230 V, 370 W, 2800 rpm, 2 m cable with Schuko plug	35	1.5	8730
② Cematic Blue pump 12V self-priming plastic diaphragm pump, 12 V, 280 W, 2 m connecting cable with crocodile clips	35	1.5	10152
Cematic Blue pump 24V self-priming plastic diaphragm pump, 24 V, 280 W, 2 m connecting cable with crocodile clips	35	1.5	10153

### ACCESSORIES FOR ELECTRIC PUMPS CEMATIC BLUE

Description	Order no.
 DN 19 hoesetail with 1" IT union nut with locknut	8731
 90°elbow with union nuts for K24 flow meter	8732
 Connecting piece, straight with union nuts for K24 flow meter	8733
 DN 19 hoesetail, 90° elbow with union nut	8611

For other accessories such as hoses and meters, see pages 95.

### Submersible pump Squalo 35

- submersible centrifugal pump 140mm diameter, suitable for common tanks and IBCs
- 230 V, 370 W
- Innovative pressure regulation system. Almost constant pressure and flow over the entire operating range.
- 1" connection with internal thread, with non-return valve
- 5 m connection cable without plug



AUS32 (AdBlue®)  
Water

### SUBMERSIBLE PUMP SQUALO 35

Description	Dispensing volume L/min	Pressure (max) in bar	Order no.
Submersible pump Squalo 35, 230 V/50 Hz, with Timer ca. 6 min	35	2.0	11255



# **STORAGE OF HAZARDOUS SUBSTANCES**







# The basics of hazardous material storage



When storing hazardous materials, various basic legal conditions are to be observed. The essential relevant information is presented below.

**Cause for concern principle:**

Water is the most important foundation for life and is irreplaceable. This fact has always been true, and endangering the water supply is a threat to our future. This is why the so-called “cause for concern principle” is central to the (German federal) Water Resources Management Act. In the words of a lawyer: “Cause for concern exists not only when a harmful event is likely to occur but even as soon as a harmful event is not unlikely to occur.”

- ✓ Determine your water hazard class
- ✓ Note the classification of flammable liquids (see table on right)
- ✓ Observe the legal requirements
- ✓ Ensure that your collection trays are positioned correctly
- ✓ Check that your tray is made from a material that is resistant to the media held in it



Examples	WGK	GHS
Alcohol (ethanol), acetone	1	extremely flammable
Anti-freeze for radiators (glycol)	1	not flammable
AdBlue®	1	not flammable
Diesel fuel/heating oil	2	liquid with flash point > 55 resp. 60 °C
Normal petrol	3	highly flammable
Unused lubrication oils	2	not flammable
Old oil (known origin)*	3	liquid with flash point > 55 resp. 60 °C
Old oil (unknown origin)*	3	highly flammable
Coolant lubrication emulsion	3	not flammable
CKW (Tri, Per, etc.)	3	not flammable



## Collection trays

### Spill trays



### Spill pallets/sumps for drums



### IBC bunds



### Workfloors/ground protection systems



### HazMat racks and cabinets

Bunds on several levels



# Collection trays in comparison

## Characteristic

GRP	PE	steel
-----	----	-------

### CORROSION RESISTANCE

Trays must remain impervious to liquids across their entire service life and may not be impaired in this function.

No corrosion across entire service life.

No corrosion across entire service life.

Vulnerable to corrosion: check regularly.

### COMPULSORY CHECKS OF THE TRAY BASE

The underside of the collection tray and the grating must be visually inspected every two years. The result must be recorded and presented to the responsible water authorities upon request.

No compulsory check, as material does not corrode.

No compulsory check, as material does not corrode.

Vulnerable to corrosion: regular checking and recording compulsory.

### CLEANING THE INSIDE OF THE TRAY

The operator must check at least once a week by means of visual inspection whether any liquid has leaked out of the containers. Any liquid that has leaked out must be removed immediately.

Smooth inside surfaces make it easy to clean the tray if necessary.

Necessary reinforcements make cleaning harder.

Smooth inside surfaces enable simple cleaning.

### TRAY STRENGTH

The walls of the tray must be dimensioned in such a way that they absorb the forces acting upon them. The trays may only be placed on suitable surfaces.

The material structure enables both high strength and low wall thickness.

High wall thicknesses and reinforcements are necessary for strength.

Required minimum wall thickness 3 mm.

### TRAY HANDLING

The handling characteristics depend heavily on the weight of the trays.

Low weight through relatively low material thicknesses.

Higher material thicknesses have a negative effect on the tray weight.

Highest weight results in difficult handling, e.g. when checking the tray base.

### TRAY MATERIAL DURABILITY

The prescribed requirements for the trays remain fully valid across the entire service life.

The material characteristic does not change throughout the entire service life.

Strength is reduced as a result of the natural ageing process.

Corrosion impairs the required impermeability over a longer period.

### CEMO recommendation for tray material:

**Diesel, fresh and used oils, weak lyes and acids**

**Lyes and acids**

**Petrol, highly flammable liquids**

## Comparison of the suitability of sump/spill pallets made from different materials

(confirmed by independent experts)

used with various media typical in industrial concerns and workshops

Material of collection trays	Media stored						
	Waste oil of known origin (flammable, flash point > 55 °C)	Heating oil and diesel (flammable, flash point > 55 °C)	Petrol, nitro (extremely flammable, highly flammable, flammable)*	Lyes up to pH 8	Lyes over pH 8	Acids up to 10 % salt solutions pH 6-8 fixing baths	Acids up to 20 % battery acid 37%
GRP	X	X	–	X	–	X	X
Steel painted or galvanised	X	X	X	X	–	–	–
PE = polyethylene	–	–	–	X	X	X	X
X certified and resistant	– not certified / not resistant				If necessary, please enquire about individual resistances.		

\* Special storage space requirements are to be observed. (fire protection, explosion protection).



## GRP sumps / spill pallets

### GRP SUMPS ARE IDEAL FOR THE STORAGE OF ENVIRONMENTALLY HAZARDOUS SUBSTANCES.

GRP is a universally applicable material for the storage of environmentally hazardous substances. The thermosetting plastic base structure in conjunction with the glass fibre reinforcement provide an

advantageous fire performance and high chemical resistance. GRP sumps combine the properties of steel and plastic. Due to their absolute corrosion resistance, GRP sumps can be placed directly on

the ground. The low installation height facilitates easy handling in factories and workshops.

**Extremely favourable price/performance ratio**



universal application  
e.g. waste oil, lyes and acids

absolutely corrosion-resistant  
(no welding seams)

low installation height, because no  
ground clearances are required  
(compare steel sumps/spill pallets)

smooth inside walls  
ensure simple cleaning

minimal inspection requirements,  
no additional inspection of  
sump floor (compared to steel  
sump/spill pallets)

Example:  
GRP sump 220/2

### Our PREMIUM product line GRP



Due to the excellent material properties created by reinforcing the three-dimensionally meshed duroplastic material with glass fibres, GRP has been used for decades to make high-performance products that are expected to have a long service life in tough environments and at the same time ensure high levels of safety.

GRP combines the positive properties of steel and plastic.

## GRP sumps PG 9

**GRP sumps with general construction inspection certification no. Z-40.12-227**

- for the storage of strongly water polluting substances



Sump/spill pallet 220/2



Sump/spill pallet 220/4

Sump/spill pallet 150 for Euro pallets



### Mobile sump/spill pallets from GRP

- hot-dip galvanised grating
- hot-dip galvanised chassis with collision protection
- 2 steering and 2 fixed castors (castors dia. 12.5 cm) as well as a handle for trouble-free steering



Accessory: loading rails  
Accessories see page 140



Accessory: steel foot-frame, galvanised

## Sumps Type RC PG 9







**GRP sumps type RC without certification**

- suitable as a collection tray for materials not hazardous to water or for uses for which no certification is required





Sump/spill pallet 220/3-RC

## GRP sumps and RC sumps PG 9

Description / Type	External dimensions cm (l x w x h)	Collection volume L	Loading capacity kg	Quantity 200 L drums	Weight approx. kg	with general construction inspection certification	Type RC, without certification
						Order no.	Order no.
<b>GRP sump/spill pallet 65</b>							
 without grating	82 x 41 x 23	65	-	-	4	7086	10380
with galvanised steel grating	82 x 42 x 24	65	40	-	9.5	7717	10381
<b>GRP sump/spill pallet 150 for Euro pallets</b>							
 without fixture	120 x 80 x 16.5	150	-	-	9	5113	10382
with fixing pins	120 x 80 x 20.8	150	-	-	9	5114	10383
with galvanised steel grating	120 x 80 x 19.0	140	250	-	25	7963	10384
with fixing pins and galvanised steel grating	120 x 80 x 23.5	140	250	-	25	7970	10385
<b>GRP sump/spill pallet 220/1</b>							
 without grating	85 x 85 x 39	210	-	1	13	7867	10386
with galvanised steel grating	85 x 85 x 40	210	400	1	27	7868	10387
complete with GRP grating	85 x 85 x 40	210	400	1	20	7869	10388
<b>GRP sump/spill pallet 220/2</b>							
 without grating	128 x 85 x 27	220	-	1	13	6882	10389
with galvanised steel grating	128 x 85 x 29	220	800	2	33	6875	10390
complete with GRP grating	128 x 85 x 29	220	800	2	24	6886	10391
<b>GRP sump/spill pallet 220/3</b>							
 without grating	188 x 85 x 19	220	-	1	18	7085	10392
with galvanised steel grating	188 x 85 x 20	220	1200	3	46	7083	10393
complete with GRP grating	188 x 85 x 20	220	1200	3	36	7286	10394
<b>GRP sump/spill pallet 220/4</b>							
 without grating	128 x 128 x 18	220	-	1	18	6884	10395
with galvanised steel grating	128 x 128 x 21	220	1300	4	46	6876	10396
complete with GRP grating	128 x 128 x 20	220	1300	4	36	6943	10397

Accessories see page 140

## MOBILE SUMP/SPILL PALLETS FROM GRP

Description / Type	External dimensions cm (l x w x h)	Height of loading area	Collection volume L	200 L drum Items	Loading kg	Weight approx. kg	Order no.
 220/1-mobile	109 x 86 x 108	56	210	1	400	50	7870
 220/2-mobile	152 x 86 x 108	44	220	2	800	60	7834



# GRP sumps PG 9

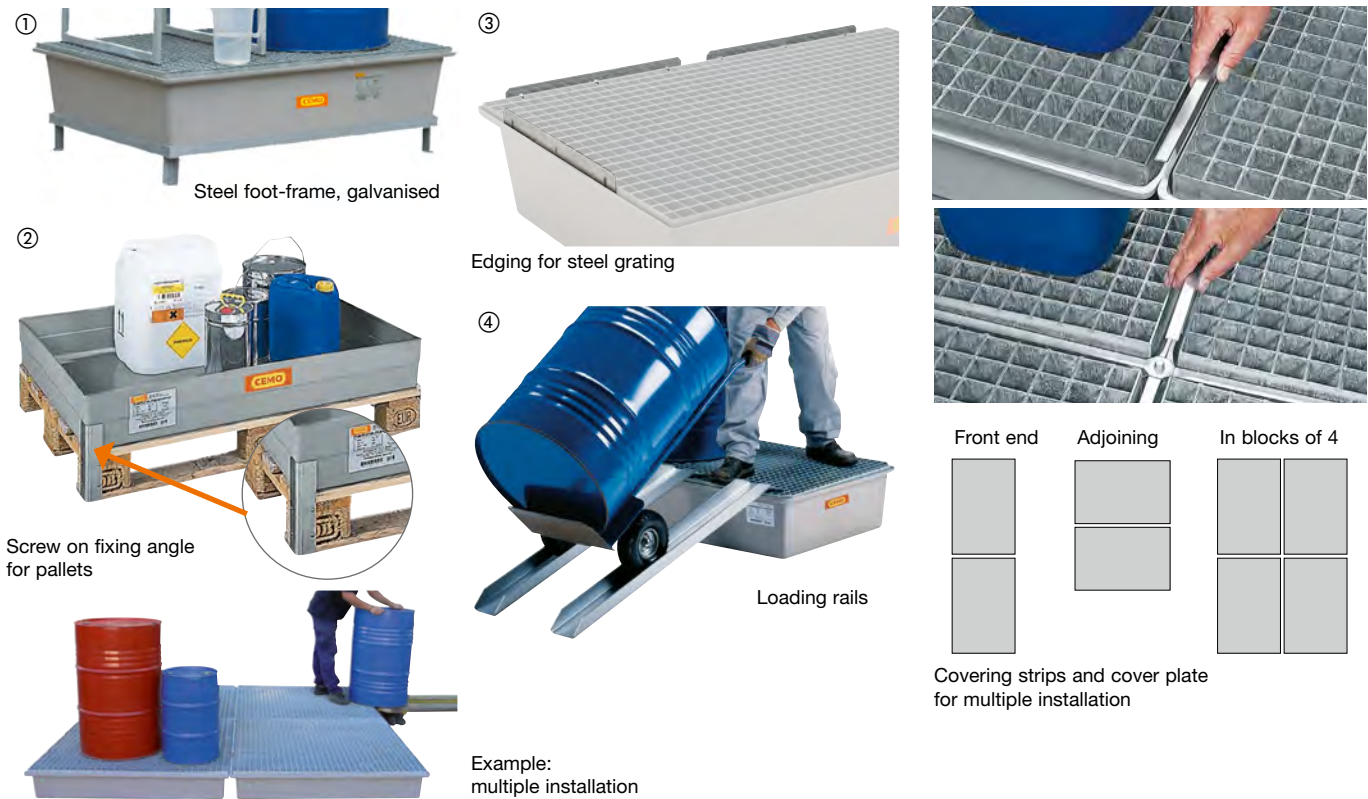

## ACCESSORIES FOR GRP SUMP/SPILL PALLETS

Description	External dimensions cm (l x w x h)	Weight approx. kg	Order no.
① Steel frame, galvanised (max. drive-under height 96 mm) only for GRP sump/spill pallet 220/2	117 x 78 x 14	15	6889
② Screw on fixing plate for pallets (2 off with screws) only for GRP pallet sump/spill pallet 150		0.5	5112
③ Edging (4-part), galvanised for sideways insertion in the steel grating, to stop storage material such as small containers, etc. from falling off)			6990
④ Loading rails, galvanised (2 off), width inside 15 cm			6878

Description		External dimensions cm (l x w x h)	Weight approx. kg Steel / GRP	Galvanised steel	GFK
				Order no.	Order no.
Grating for GRP sump/spill pallet	65	80 x 40 x 3	6 / -	7641	-
	150	118 x 78 x 3	12.5 / -	8121	-
	220/1	83 x 83 x 3	14 / 7	8176	10601
	220/2	125 x 83 x 3	18 / 11	6883	6887
	220/3	185 x 83 x 3	28 / 18	7084	7338
	220/4	125 x 125 x 4	28 / 18	6885	6941

## ACCESSORIES FOR MULTIPLE INSTALLATION

Type	Description	Number required			Order no.
		220/2	220/3	220/4	
Front end	Covering strip short	1	1	-	6967
Adjoining	Covering strip long	1	-	1	6968
In blocks of 4	Cover plate	1	-	1	6969
	Covering strip short	2	-	-	6967
	Covering strip long	2	-	4	6968

# PE sump/spill pallets

## PE SUMP/SPILL PALLETS WITH AN IDEAL PRICE/PERFORMANCE RATIO

CEMO always offers a suitable solution when it comes to collecting water-polluting substances. Environmentally compatible, proper and safe storage of hazardous materials is an important topic for every company.

Caustic or toxic substances require special care during handling and storage. For purposes of protection and a clean environment, we have developed a range of PE sump/spill pallets which offer great functionality and high resistance against

acids and lyes thanks to the diverse variation options which ensures an ideal price/performance ratio for you.



- ✓ high chemical resistance
- ✓ great functionality



various options:  
with fixing pins,  
feet, skids or castors

the tray can be placed directly on  
the floor or a Euro pallet

Example: suitable  
for Euro pallets



PE small container and rack trays



PE sump/spill pallet 120 x 80 mm  
with a collection volume of 242 L



PE filling station  
with a collection volume of 450 L

# EURO PE sump/spill pallet 250/2 PG 9

## Euro PE sump/spill pallet 250/2 with general construction inspection certification no. Z-40.22-420

- manufactured from high quality polyethylene (HDPE)
- high chemical resistance
- collection capacity without grating 250 L, with grating 224 L

- for storing drums up to 224 L
- high functionality
- tray can be positioned directly on the floor or on a Euro-pallet
- versions with locking pins (for Euro-pallets), feet, runners or castors

## Euro PE sump/spill pallet 250/2 - RG without certification no.

- manufactured from high quality recycled polyethylene
- suitable as a collection tray for materials not hazardous to water or for uses for which no certification is required



With 4 feet and PE grating



Integrated recessed handles for easy lifting



With 2 runners and steel grating



With steering castors

Description / Capacity L	External dimensions cm (l x w x h)	Capacity kg	Quantity 200 L drums	Weight approx. kg	with General Construction Inspection Certification	without certification 250/2 RG
					Order no.	Order no.
<b>EURO PE SUMP/SPILL PALLET 250/2</b>						
without grating	120.5 x 80.5 x 33	600	1	16	8276	8424
with galvanised steel grating	120.5 x 80.5 x 33	600	2	29	8277	8425
with PE grating	120.5 x 80.5 x 34	600	2	29	8278	8426
<b>EURO PE SUMP/SPILL PALLET 250/2 WITH 4 FEET</b>						
without grating	120.5 x 80.5 x 43	600	1	18	8279	8427
with galvanised steel grating	120.5 x 80.5 x 43	600	2	31	8280	8428
with PE grating	120.5 x 80.5 x 44	600	2	31	8281	8429
<b>EURO PE SUMP/SPILL PALLET 250/2 WITH 2 RUNNERS</b>						
without grating	120.5 x 80.5 x 43	600	1	20	8282	8430
with galvanised steel grating	120.5 x 80.5 x 43	600	2	33	8283	8431
with PE grating	120.5 x 80.5 x 44	600	2	33	8284	8432
<b>EURO PE SUMP/SPILL PALLET 250/2 MOBILE WITH STEERING AND FIXED CASTORS*</b>						
without grating, with steel base-frame	129 x 80.5 x 104	400	1	26	8285	8433
with galvanised steel grating	129 x 80.5 x 104	400	2	37	8286	8434
with PE grating and steel base-frame	129 x 80.5 x 104	400	2	39	8287	8435

\* Loading height 250/2 mobile 49 cm, castor dia. 12.5 cm

Accessories see page 143



## EURO PE sump/spill pallet 250/2 PG 9

### Canister rack system

The rack system is designed for the Euro PE sump/spill pallet 250/2 in versions: without feet or runners (8276 + 8277), with feet (8279 + 8280) and with runners (8282 + 8283).  
Loading capacity per shelf: 100 kg.



Euro PE sump (8277), canister rack system base unit (8523) and extension unit (8627)



Accessory:  
PE grating



Accessory:  
locking pins



Accessory:  
sump/spill pallet attachment



### CANISTER RACK SYSTEM FOR EURO PE SUMP/SPILL PALLET 250/2

Description	Overall dimensions* cm (l x w x h)	Heights of shelves in cm from the ground*	Weight approx. kg	Order no.
Canister rack system base unit for Euro PE sump/spill pallet 250/2, consisting of 4 push-on support elements and one steel grating (excludes sump)	120.5 x 80.5 x 81	33 / 81	19	8523
Canister rack system attachment unit for Euro PE sump/spill pallet 250/2, consisting of 4 push-on support elements and one steel grating (excludes sump)	120.5 x 80.5 x 129	129	19	8627

\* Scope includes Euro PE sump/spill pallet 250/2 with steel grating (8277)

### ACCESSORIES

Description	Order no.
Locking pins for fixing the Euro PE sump/spill pallet 250/2 onto a Euro pallet (4 pcs. incl. fittings)	8288
Steel grating, galvanised for PE sump/spill pallet 250/2	8324
PE grating for PE sump/spill pallet 250/2	8325
Sump/spill pallet attachment (height 20.5 cm)	8358

## PE sump/spill pallet 250<sup>HD</sup> PG 9

HD = HIGH DENSITY

**PE sump/spill pallet 250<sup>HD</sup>**  
with general construction inspection certification Z-40.22-548 from polyethylene

- fully recyclable
- can be used with/without perforated plate
- non-slip plate surface
- maintenance friendly
- trays can be connected to form a surface protection system, see page 163
- leak indicator is included free of charge (see page 147)



PE sump/spill pallet 250<sup>HD</sup>, with PE perforated plate

### PE SUMP/SPILL PALLET<sup>HD</sup>

Description	Overall dimensions cm (l x w x h)	Loading capacity kg	Collection volume L	Quantity 200 L drums	Weight approx. kg	Order no.
PE sump/spill pallet 250 <sup>HD</sup>	160 x 120 x 16.5	-	250	2	10.5	10712
PE sump/spill pallet 250 <sup>HD</sup> with PE perforated plate	160 x 120 x 18	1000	250	5	25.7	10713

# PE pallet sumps and PE drum bunds

The new generation of CEMO PE pallet sumps and PE drum bunds has arrived. The polyethylene (PE) sumps and bunds are highly resistant to chemicals. Thanks to the different sizes and versions, we have a solution for almost any application.

### PE pallet sumps

- Matched to the size of a Euro pallet (120 x 80 cm) or an industrial pallet (120 x 120 cm).
- You can place the transport pallet directly on the bund or use a steel or PE grating as the deck surface.



Pallet sump 220/2 with wooden pallet



Pallet sumps 425/4 with steel grating



Pallet sump 220/4 with PE grating



Video PE pallet sumps and PE drum bunds

### PE drum bunds

- Grating dimensions match the size of 200L drums
- no wasted space



Drum bund 220/3



Drum bund 220/4e

## PE pallet sumps PG 9

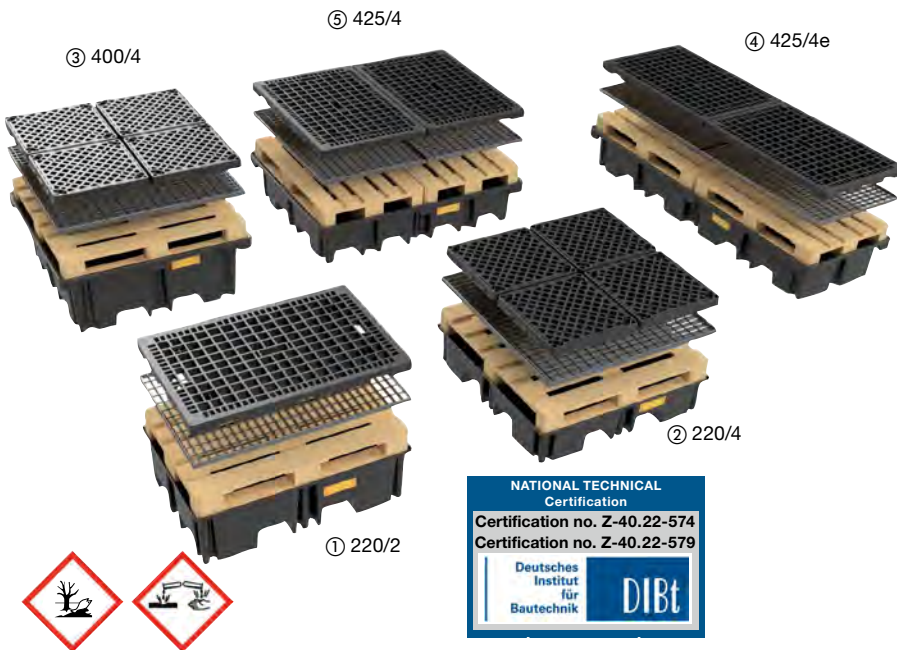

### PE pallet sumps with General Construction Inspection Certification Z-40.22-574 and Z-40.22-579

- made from high-quality polyethylene (PE)
- high chemical resistance
- Sumps can be placed directly on the floor
- with integral forklift pockets
- accessible from four sides (except tray for two 120 x 80 pallets lengthwise)
- ideal for Euro pallets (120 x 80) or industrial pallets (120 x 120), and for plastic pallets of similar sizes
- loaded pallets can be placed directly on the tray using a forklift or high-platform truck
- a steel or PE grid is not required, but can be used if desired

### PE pallet sumps – RG non-certified

- made from high-quality polyethylene regranulate
- suitable as sumps for non-water-hazardous substances or where certified products are not required

Description / Type	Overall dimensions cm (l x d x h)	Loading capacity kg	Collection volume L	Quantity pallets	Quantity 200 L drums	Weight approx. kg	with General Construction Inspection Certification	PE sumps RG non-certified
							Order no.	Order no.
① PE pallet sump 220/2 for 1 pallet 120 x 80								
without grating	123 x 83 x 36	600	220	1	2	13	11257	11484
with steel grating	123 x 83 x 36	600	220	1	2	25.4	11258	11485
with PE grating	123 x 83 x 39	600	220	1	2	21.5	11259	11486
② PE pallet sump 220/4 for 1 pallet 120 x 120								
without grating	123 x 123 x 26	1200	220	1	4	13.5	11260	11487
with steel grating	123 x 123 x 26	1200	220	1	4	43.5	11261	11488
with PE grating	123 x 123 x 29	1200	220	1	4	26	11262	11489
③ PE pallet sump for 1 pallet 120 x 120								
without grating	129 x 129 x 48	1200	400	1	4	15.5	11276	-
with steel grating	129 x 129 x 48	1200	400	1	4	45.5	11277	-
with PE grating	129 x 129 x 50	1200	400	1	4	28	11278	-
④ PE pallet sump for 2 pallets 120 x 80 längs								
without grating	242 x 88 x 36	1200	425	2	4	17.5	11263	-
with steel grating	242 x 88 x 36	1200	425	2	4	42.3	11264	-
with PE grating	242 x 88 x 39	1200	425	2	4	34.5	11265	-
⑤ PE pallet sump for 2 pallets 120 x 80 quer								
without grating	167 x 127 x 36	1200	425	2	4	17	11266	-
with steel grating	167 x 127 x 36	1200	425	2	4	41.8	11267	-
with PE grating	167 x 127 x 39	1200	425	2	4	34	11268	-

## ACCESSORIES FOR PE PALLET SUMPS

Description/Type	Overall dimensions cm (l x d x h)	Loading capacity kg	Weight approx. kg	Order no.
Steel grid for PE pallet sump 220/2, 425/4, 425/4e	120 x 80 x 3	600	12.4	11269
Steel grid for PE pallet sump 220/4, 400/4	120 x 120 x 3	1200	30	11270
PE grid for PE pallet sump 220/2, 425/4, 425/4e	120 x 80 x 6	600	8.5	10286
PE grid 60 x 60 (4 x) for PE pallet sump 220/4, 400/4	120 x 120 x 7	4 x 300	12.5	11281



## PE drum bunds PG 9

### PE drum bunds with General Construction Inspection Certification Z-40.22-579

- made from high-quality polyethylene (PE)
- high chemical resistance
- bund can be placed directly on the floor
- with integral forklift pockets
- accessible from two sides
- ideally suited for drums
- only one PE grid size for all versions



220/3



220/6

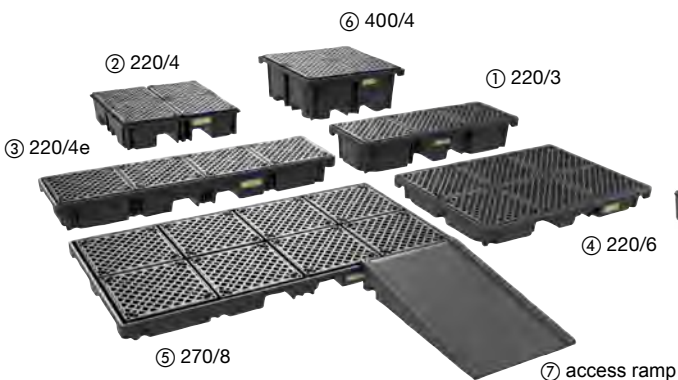

270/8

Description / Type	Overall dimensions cm (l x d x h)	Loading capacity kg	Collection volume L	Quantity PE grating	Quantity 200 L drums	Weight approx. kg	Order no.
① 220/3	186 x 66 x 33	900	215	3	3	23	11272
② 220/4	123 x 123 x 29	1200	220	4	4	26	11262
③ 220/4e	245 x 66 x 26	1200	215	4	4	24.5	11273
④ 220/6	186 x 126 x 20	1800	220	6	6	33	11274
⑤ 270/8	248 x 128 x 18	2400	270	8	8	44	11275
⑥ 400/4	129 x 129 x 50	1200	400	4	4	35.5	11278

## ACCESSORIES FOR PE DRUM BUNDS

Description/Type	Overall dimensions cm (l x d x h)	Loading capacity kg	Weight approx. kg	Order no.
⑦ Access ramp for PE drum bunds 220/8	126 x 80 x 20	300	13	11282
PE grating 60 x 60	60 x 60 x 7	300	3.1	11283

# Small PE container/laboratory trays<sup>HD</sup> PG 9

HD = HIGH DENSITY

## Small PE container/laboratory trays with general construction inspection certification Z-40.22-548 and Z-40.22-549

- small container/laboratory trays from polyethylene
- fully recyclable
- can be used with/without perforated grating
- stackable for space-saving storage/transport
- non-slip grating surface
- maintenance friendly
- designed for Euro-pallets
- trays can be connected to form a surface protection system, see p. 158



PE sump/spill pallet 25<sup>HD</sup> with and without PE grating



PE sump/spill pallet 30<sup>HD</sup> with and without PE grating



PE sump/spill pallet 60<sup>HD</sup> with PE grating

## PE Container/laboratory trays<sup>HD</sup> - RG without certification no.

- manufactured from high quality recycled polyethylene
- suitable as a collection tray for materials not hazardous to water or for uses for which no certification is required



PE sump/spill pallet 25<sup>HD</sup> with PE grating as laboratory tray



PE sump/spill pallet 120<sup>HD</sup> with PE grating

## A significant plus in safety in the daily handling of hazardous liquids

**COST-FREE**  
visual leakage indicator  
for every tray with PE grating



If liquid has flowed unnoticed into the drip tray, then the visual leakage indicator free floats and becomes visible.



Description	Overall dimensions cm (l x w x h)	Loading capacity kg	Collection volume L	Weight approx. kg	with General Construction Inspection Certification	without certification PE-trays RG
					Order no.	Order no.
PE sump/spill pallet... ... 25 <sup>HD</sup>	60 x 40 x 16.5	-	25	1.8	10704	10884
... 25 <sup>HD</sup> with PE grating	60 x 40 x 18	125	25	3.7	10705	10885
... 35 <sup>HD</sup>	80 x 40 x 16.5	-	35	2.2	10706	10886
... 35 <sup>HD</sup> with PE grating	80 x 40 x 18	160	35	4.8	10707	10887
... 60 <sup>HD</sup>	80 x 60 x 16.5	-	60	3	10708	10888
... 60 <sup>HD</sup> with PE grating	80 x 60 x 18	250	60	6.8	10709	10889
... 120 <sup>HD</sup>	120 x 80 x 16.5	-	120	5.2	10710	10890
... 120 <sup>HD</sup> with PE grating	120 x 80 x 18	500	120	12.8	10711	10891
... 250 <sup>HD</sup>	160 x 120 x 16.5	-	250	10.5	10712	10892
... 250 <sup>HD</sup> with PE grating	160 x 120 x 18	1000	250	25.7	10713	10893
Accessory PE grating 60 x 40	60 x 40 x 17	125	-	1.9	10715	10894
Accessory PE grating 40 x 40	40 x 40 x 17	80	-	1.3	10716	10895

# PE filling stations and folding trays PG 9

## PE filling station 450 L with general construction inspection certification no. Z-40.22-380

- made from high-quality polyethylene (PE)
- high chemical resistance
- collection volume 450 L
- suitable as a storage and filling station for two 200-L barrels (with additional drum pallet for four 200-L drums)
- forkliftable



PE filling station 450 L



PE filling station with PE drum pallet (accessory)



Description	Overall dimensions cm (l x d x h)	Containment capacity L	Quantity 200 L drums	Weight approx. kg	Order no.
PE filling station 450 L	135 x 138 x 64	450	2	46	8674
Accessory: PE drum pallet	94 x 138 x 39	-	2	15	8675

## Folding tray 8/12

This flexible, flat PVC tarpaulin can quickly and easily be turned into a resistant collection tray; it can be used as an emergency tray or as a transport and consignment container that can protect people and the environment against water-polluting liquids.

- multi-function container tray
- flexible collecting tray, extremely adaptable to different spaces

- built-in contents gauge
- space-saving when folded up
- ready for use in seconds
- impervious to liquid
- easy forklift access when empty
- resistant to oils, chemicals and technical fluids
- material: PES, surface-coated with PVC on both sides, blue



Description	External dimensions expanded cm (l x w)	External dimensions tray cm (l x w x h)	Package size cm (l x w x h)	Collection volume L	Weight approx. kg	Order no.
Folding tray 8/12 with carry bag	130 x 170	84 x 124 x 22.5	45 x 70 x 12	210	5.5	10179

## Folding tray 30 L

This folding collection tray is made from PVC and has built-in reinforcement plates; its extremely flat design means it can be transported in any vehicle.

It is ideally suited for transporting hazardous materials on construction, agricultural and forestry machines. This saves you unnecessary costs caused by leaking chemicals or oils.

- flat design, low space requirement when unfolded (only 2.5 cm high)

- quick assembly with Velcro fasteners
- absolutely impervious to liquid
- resistant to many chemicals and oils



Description	Collection volume L	External dimensions cm (l x w x h)	Collapsed dimensions cm (l x w x h)	Weight approx. kg	Order no.
Folding tray	30	60 x 40 x 25	60 x 40 x 2.5	1.2	10183



# Small containers and collection tray PE

## PE collection tray 30-MOBILE PG 9

PE collection trays with general construction inspection certification no. Z-40.22-388

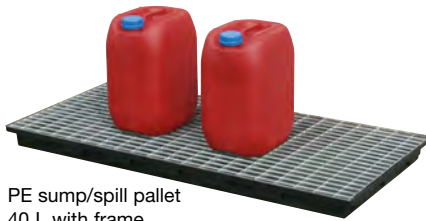

PE sump/spill pallet 40 L with frame



PE sump/spill pallet 40 L



Suitable for hazardous substance cabinet 13/20...



... drum racks 360, 540 and hazardous substances racks.



### PE sump/spill pallet 30-mobile

- chassis galvanised with 2 steering and 2 fixed castors, dia. 100 mm, as well as a pushing handle for trouble-free maneuvering
- for carrying and storage of water-polluting substances such as cleaning agents, pesticides, used oil filters, oil-coated machine components
- PE collection tray can be removed for cleaning



PE sump/spill pallet 30-mobile

Description/Type		External dimensions cm (l x w x h)	Collection volume L	Loading capacity kg	Weight approx. kg	Order no.
PE collection tray 30	without grating	98 x 60 x 8.5	30	-	4	8076
	complete with steel grating	98 x 60 x 8.5	30	50	10	8077
PE collection tray 40	without grating	130 x 62 x 8	40	-	5	7871
	complete with steel grating	130 x 62 x 8	40	50	13	7872
PE collection tray 30-mobile		112 x 63 x 104	30	100	28	8166

### ACCESSORIES FOR PE COLLECTION TRAYS AND PE COLLECTION TRAY 30-MOBILE

Description	Weight approx. kg	Order no.
Steel grating galvanised for PE collection trays 30 L	6	8167
Steel grating galvanised for PE collection trays 40 L	8	8168

## Canister filling stand PG 9

- facilitates emptying of canisters up to 60 L
- cage secures mounting of canisters
- precise measuring by swivelling of the canister
- made from highly resistant stainless steel – suitable for acids and lyes
- wall mounting possible



Canister filling stand for canisters up to 30 L



Canister filling stand for canisters up to 60 L

Description/Typ	External dimensions cm (l x w x h)	max. canister dimensions cm (l x w x h)	Weight approx. kg	Order no.
Canister filling stand for canisters up to 30 L	67 x 39 x 74	31 x 29 x 48	5.4	8007
Canister filling stand for canisters up to 60 L	67 x 47 x 82	42 x 37 x 65	7.5	10100

# Steel sump/spill pallets

## SPILL PALLETS OFFERING EXCELLENT VALUE FOR MONEY

In the early days of the Environmental Protection Industry, spill pallets/sumps were made of steel. This material offers strength, rigidity and endurance. In the arena of professional manufacturing in a regulated industry, steel sumps emerged as a high-quality, premium sump for

hazardous materials. Before leaving the factory, every sump is tested for being leak-proof.

Companies should only implement products that conform to Water Resources Act standards, and have recognised certification.

All CEMO's steel bunds have the StawaR certification and are allowed to display the Ü mark.

### IBC bunds

Designed for the storage of large containers such as KTC/IBC, ASF and ASP containers up to 1,000 litres.

### Spill pallets

Our spill pallets come in various sizes and are available with or without hot-dip galvanised, removable grating (required for flammable liquids).

Forklift accessible for assembly and transport



Type SW2  
galvanised without grating

#### Practical tip:

As a rule, CEMO generally recommends using spill pallets with galvanised grating. This provides the clear advantage of a level storage area for ease of loading and unloading. In addition, the full legally required collection volume is not reduced by drums placed directly in the spill pallet and therefore, the spill pallet will not overflow if the drums should leak.

#### Safety information:

When storing flammable liquids, please note that the German technical regulation TRGS 510 defines special fire protection and explosion prevention requirements applicable above a specific volume. These requirements can be met in practice by maintaining safety distances, earthing equipment and suitable storage spaces such as F90 containers and fire-resistant rooms, for example.



Example application:  
Filling from a 60 litre drum.  
Spill pallet in combination with filling stand (see p. 154)



**TÜV certified products**  
**Certified under StawaR**  
**U** Manufacturer's declaration of conformity (ÜHP) according to Construction Products List A Part 1, DIBt Berlin



**Surface protection system**

The modular, matched elements of our surface protection system are also available in steel.

**Mobile sump/spill pallet**

Two steering and two fixed castors for easy manoeuvring and push handle for trouble-free positioning.

**Small spill trays**

For containers up to 30 litres. Highly versatile applications, such as decanting liquids on the workbench.



Spill pallet with and without grating



Painted spill pallet GS1a AB1 with filling area and filling stand



Drum rack type 540 with steel bund



# Steel sump/spill pallets PG 9

## Fireproof storage and transport assured

Steel bunds 3 mm thick ensure safe storage of water-hazardous and flammable substances. The product range offers many options for a wide variety of applications for small containers, canisters and drums. Sump/spill pallets have 100 mm ground clearance.



### for 200 L drums



Type SW6 painted without grating



Type SW2 galvanised without grating



Type SW1 painted with grating



Type SW2 painted with grating



Type SW3 painted with grating



Typ SW4 galvanised with grating



Type SW8 painted with grating



Type SW10 painted with grating

Type SW65/2 painted without grating

Type SW65/4 painted without grating

Type SW65/2 painted with grating

Type SW65/4 painted with grating

Type SW600/2 painted with grating (example with DT-Mobile Easy 600 litre)

### for 60 L drums

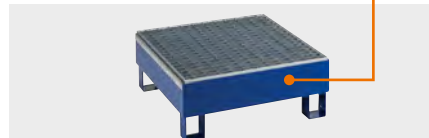

Type SW4e painted with grating

## Steel sump/spill pallets PG 9

### SUMP/SPILL PALLETS WITHOUT GRATING FOR 60 L DRUMS

Description/ Type	External dimensions cm (l x w x h)	Collection volume L	Capacity / no. of 60 L drums	Loading kg	Weight approx. kg	Painted model	Galvanised model
						Order no.	Order no.
Type SW65/2 o. GR	82 x 41 x 32	65	one 60 L drum and small container	200	23	11473	11474
Type SW65/4 o. GR	80 x 80 x 23	65		400	27	11475	11476

### SUMP/SPILL PALLETS WITH GRATING FOR 60 L DRUMS

Description/ Type	External dimensions cm (l x w x h)	Collection volume L	Capacity / no. of 60 L drums	Loading kg	Weight approx. kg	Painted model	Galvanised model
						Order no.	Order no.
Type SW65/2	82 x 42 x 33	65	2 x 60 L drum	200	29.5	11477	11478
Type SW65/4	80 x 81 x 25	65	4 x 60 L drum	400	37	11479	11480

### SUMP/SPILL PALLETS WITHOUT GRATING FOR 200 L DRUMS

Description/ Type	External dimensions cm (l x w x h)	Collection volume L	Capacity / no. of 200 L drums	Loading kg	Weight approx. kg	Painted model	Galvanised model
						Order no.	Order no.
Type SW1 o. GR	80 x 80 x 44	205	one 200 L drum and small container	400	46	8529	8530
Type SW2 o. GR	120 x 80 x 35	210		800	50	7582	7680
Type SW3 o. GR	180 x 80 x 28	205		1200	61	10138	10139
Type SW4 o. GR	120 x 120 x 26.5	205		1600	56	7681	7682
Type SW4e o. GR	239 x 80 x 23	205		1600	71	7683	7684
Type SW6 o. GR	201 x 120 x 25.6	308		2400	87	10402	10403
Type SW8 o. GR	239 x 120 x 20	205		3200	92	7685	7686
Type SW10 o. GR	300.6 x 120 x 25.6	462		4000	125	10404	10405

### SUMP/SPILL PALLETS WITH GRATING FOR 200 L DRUMS

Description/ Type	External dimensions cm (l x w x h)	Collection volume L	Capacity / no. of 200 L drums on grating	Loading kg	Weight approx. kg	Painted model	Galvanised model
						Order no.	Order no.
Type SW1	80 x 81 x 46	205	1 x 200 L drum	400	56	8531	8532
Type SW2	120 x 81 x 36	210	2 x 200 L drum	1000	64	7583	7687
Type SW3	180 x 80.5 x 29	205	3 x 200 L drum	1200	90	10140	10141
Type SW4	120 x 121 x 28.5	205	4 x 200 L drum	1600	94	7688	7689
Type SW4e	239 x 81 x 25	205	4 x 200 L drum	1600	100	7690	7691
Type SW6	201 x 120.5 x 26.6	308	6 x 200 L drum	2400	122	10406	10407
Type SW8	239 x 121 x 21	205	8 x 200 L drum	3200	166	7692	7693
Type SW10	300.6 x 120.5 x 26.6	462	10 x 200 L drum	4000	175	10408	10409

### SPILL PALLETS WITHOUT GROUND CLEARANCE

Description/ Type	External dimensions cm (l x w x h)	Collection volume L	Loading kg	Weight approx. kg	Painted model	Galvanised model
					Order no.	Order no.
<b>WITHOUT GRATING</b>						
Type SW2 o.F o.GR	120 x 80 x 24.6	210	800	47	11206	11207
Type SW4 o.F o.GR	120 x 120 x 15.6	205	1600	53	11208	11209
<b>WITH GRATING</b>						
Type SW2 o.F	120 x 80.5 x 25.6	210	1000	49	11210	11211
Type SW4 o.F	120 x 120.5 x 16.6	205	1600	76	11212	11213

### SPILL PALLETS FOR MOBILE TANK SYSTEMS FOR DIESEL UP TO 600 L

Description/ Type	External dimensions cm (l x w x h)	Collection volume L	Loading kg	Weight approx. kg	Painted model
					Order no.
<b>WITHOUT GRATING</b>					
Type SW 600/2 o. GR	120 x 81 x 81	600	600	96	11504
<b>WITH GRATING</b>					
Type SW 600/2	120 x 82 x 82	600	600	110	11505

## Steel sump/spill pallets PG 9

### Mobile steel sump/spill pallets

- with hot-dip galvanised, removable gratings
- 2 steering and 2 fixed castors as well as a pushing bar for trouble-free steering
- collection volume 205 L
- loading height SW1-mobile 49 cm, loading height SW2-mobile 42 cm



SW1-mobile galvanised



SW2-mobile galvanised

### MOBILE STEEL SUMP/SPILL PALLETS

Description / Type	External dimensions cm (l x w x h)	200 L drum items	Loading capacity kg	Weight approx. kg	Order no.
SW1-mobile painted	98 x 81 x 113	1	300	62	7397
SW1-mobile galvanised	98 x 81 x 113	1	300	62	7398
SW2-mobile painted	135 x 81 x 109	2	450	72	7399
SW2-mobile galvanised	135 x 81 x 109	2	450	72	7400
Securing belt for safer transport, 25 mm x 4 m, one-piece					7420

## Small steel collection trays PG 9

- extremely versatile use: e.g. for the decanting procedure on the work-bench, placing on a pallet, etc.
- made liquid-tight from 3 mm steel
- certified according to German regulation StawaR
- for containers up to max. 30 litres



Steel spill tray Q30



Steel spill tray R30



Description / Type	External dimensions cm (l x w x h)	Capacity L	Weight approx. kg	Order no.
① Small steel collection trays Q30	46 x 43.5 x 17	30	11	11003
② Small steel collection trays R30	90 x 44.5 x 9	30	16	11004
③ Perforated plate insert Q30	–	–	2.5	11060
④ Perforated plate insert R30	–	–	3.5	11061

## Barrel support and drum pallet for GRP, PE and steel sump/spill pallets PG 9



Description / Type	External dimensions cm (l x w x h)	Capacity	Weight approx. kg	Order no.
① Barrel support FB1	60 x 60 x 35	1 x 60 L or 1 x 200 L	15	7586
② Barrel support FB2	113 x 60 x 35	2 x 60 L or 2 x 200 L	21	7587
③ Barrel support FB3	120 x 60 x 40	3 x 60 L	17	7835
④ Barrel support stackable	63 x 45 x 53	1 x 60 L	10	7741
⑤ PE drum pallet	94 x 138 x 39	2 x 200 L	15	8675



## IBC bunds steel PG 9

### IBC bunds steel with design certification

- certified for the storage of water-hazardous and flammable substances
- designed for the storage of IBC, ASF- and ASP containers up to 1000 litres
- with galvanised, removable grates
- 100 mm ground clearance for safe transport
- painted (RAL 5002, ultramarine blue) or galvanised



IBC bund GS2a galvanised with filling area



IBC bund GS1a AB1 painted with filling stand and filling area



IBC bund GS2 AB1 painted with filling area

IBC bund GS1a painted with grating and filling area

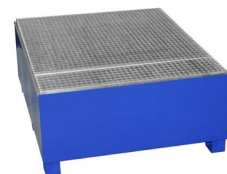

Description	Overall dimensions cm (l x w x h)	Collection volume L	Cont. à 1000 L item	Loading capacity kg	Weight approx. kg	Painted	Galvanised
						Order no.	Order no.
GS1	135 x 125 x 75	1000	1	2000	170	7392	7393
GS1a with filling area	160 x 126 x 65	1000	1	2000	179	10613	10614
GS1 AB1 with 1 filling stand	135 x 125 x 109	1000	1	2000	182	10849	10850
GS1a AB1 with 1 filling stand	160 x 126 x 100	1000	1	2000	191	10851	10852
GS2	268 x 126 x 45	1000	2	4000	238	7394	7395
GS2a with filling area	268 x 161 x 39	1000	2	4000	273	10615	10616
GS2 AB1 with 1 filling stand	268 x 126 x 80	1000	2	4000	247	10853	10854
GS2a AB1 with 1 filling stand and filling area	268 x 161 x 74	1000	2	4000	282	10855	10856
GS2 AB2 with 2 filling stands	268 x 126 x 80	1000	2	4000	256	10857	10858
GS2a AB2 with 2 filling stands and filling area	268 x 161 x 74	1000	2	4000	291	10859	10860

### ACCESSORIES FOR IBC BUNDS MADE OF STEEL

Description	External dimensions cm (l x w x h)	Collection volume L	Cont. à 1000 L item	Loading capacity kg	Weight approx. kg	Order no.
Filling stand GS ZB galvanised	133 x 122 x 40	-	1	2000	49	7396
Can holder for IBC bunds GS1 and GS2	35 x 30 x 19	-	-	-	4	8740

## IBC bunds PE PG 9

### IBC collecting trays in PE with National Technical Certification Z-40.22-564

- made from high-quality polyethylene
- high chemical resistance
- capacity 1,100 litre
- rugged PE support crossbar for high load-bearing capacity
- forkliftable with a forklift or manual lift truck (transport only when empty)
- can be stacked inside each other for transport



- ✓ rugged PE support crossbar for high load-bearing capacity
- ✓ high chemical resistance
- ✓ made from high-quality polyethylene



forkliftable

IBC bund 1100/1-PE with supporting crossbar and filling attachment

## IBC bunds PE PG 9



IBC bund 1100/1-PE  
with supporting crossbar



IBC bund 1100/1-PE  
with PE perforated plate



IBC bund 1100/1-PE with filling  
attachment and galvanised steel  
grating



Nestable for transport

IBC bund 1100/2-PE  
with galvanised steel  
grating



Description / Type	External dimensions cm (l x w x h)	Collection volume L	No. of 1000 L IBCs	Loading capacity kg	Weight approx. kg	Order no.
1100/1-PE	146 x 117 x 85	1100	1	1500	43	10938
1100/1-PE with galvanised steel grating	146 x 117 x 87	1100	1	1500	63	10947
1100/1-PE with PE perforated plate	146 x 117 x 88	1100	1	1500	53	10950
1100/1-PE with filling attachment	162 x 117 x 85	1100	1	1500	45	10939
1100/1-PE with filling attachment with galvanised steel grating	162 x 117 x 87	1100	1	1500	65	10948
1100/1-PE with filling attachment with PE perforated plate	162 x 117 x 88	1100	1	1500	55	10951
1100/2-PE	223 x 146 x 44	1100	2	3000	47	10940
1100/2-PE with galvanised steel grating	223 x 146 x 46	1100	2	3000	87	10949
1100/2-PE with PE perforated plate	223 x 146 x 47	1100	2	3000	67	10952



# PE ground protection systems<sup>HD</sup> with PE grating PG 9

## PE ground protection systems with general construction inspection certification Z-40.22-548 and Z-40.22-549

- can be used as storage/filling station
- elements can be combined to cover a complete storage area
- connection components (accessories) permit the lining of surfaces of any size that are suitable as storage and transfilling stations

- can be combined in any way with the PE collection trays on page 147 of this catalogue
- rugged, removable PE grating
- sturdy PE access ramp with an integrated fixing bolt for connection to the PE grating, slight inclination for easy loading of the floor elements
- PE grating and access ramp are non-slip
- with visual leak detector



Can be combined in any way with the PE collection trays<sup>HD</sup> on page 147



① Accessory access ramp

## PE ground protection systems - RG without certification no.

- manufactured from high quality recycled polyethylene
- suitable as a collection tray for materials not hazardous to water or for uses for which no certification is required



PE sump 120<sup>HD</sup> with PE grating



PE sump 250<sup>HD</sup> with PE grating

Description / Type	Overall dimensions cm (l x w x h)	Collection volume L	Ultimate load* kg	Weight approx. kg	with General Construction Inspection Certification	without certification PE-Systems <sup>HD</sup> RG
					Order no.	Order no.
PE sump 120 <sup>HD</sup> with PE grating	120 x 80 x 18	120	500	12.8	10711	10891
PE sump 250 <sup>HD</sup> with PE grating	160 x 120 x 18	250	1000	25.7	10713	10893

\* with an evenly distributed load

## ACCESSORIES FOR PE GROUND PROTECTION SYSTEMS<sup>HD</sup>

Description	Overall dimensions cm (l x w x h)	Order no.
① Access ramp, ultimate load 300 kg, weight approx 13 kg	126 x 80 x 20	10714
② Connecting rail, short	114 x 1.5 x 1.5	10721
③ Connecting rail, long	154 x 1.5 x 1.5	10722
Cross connector	11.5 x 11.5 x 3.5	10723

# Ground protection systems<sup>HD</sup> with galvanised grating PG 9

## PE ground protection system with general building certification Z-40.22-548 and Z-40.22-549

- implemented as storage and filling station
- components can be combined into a floor-covering storage system
- robust, removable, galvanised steel grating with feet
- optional connecting rails make it possible to cover large surfaces that are suitable as storage and filling stations

- sturdy PE ramps with integrated locating bolts for docking on the grating, with a gentle slope for easy loading on the work floor
- perforated plate and access ramp are non-slip



① Accessory access ramp



Description / Type	Overall dimensions cm (l x w x h)	Collection volume L	Ultimate load kg	Wheel load kg	Weight approx. kg	Order no.
PE spill pallet 60 <sup>HD</sup> with galvanised steel grating	80 x 60 x 18	60	1000	150	16	11135
PE Spill pallet 120 <sup>HD</sup> with galvanised steel grating	120 x 80 x 18	120	1000	150	31	11136
PE Spill pallet 250 <sup>HD</sup> with galvanised steel grating	160 x 120 x 18	250	1000	150	63	11137

## ACCESSORIES FOR PE GROUND PROTECTION SYSTEMS<sup>HD</sup>

Description	Overall dimensions cm (l x w x h)	Order no.
① Access ramp, ultimate load 300 kg, weight approx 13 kg	126 x 80 x 20	10714
② Connecting rail, short	114 x 1.5 x 1.5	11138
③ Connecting rail, long	154 x 1.5 x 1.5	11139



# PE ground protection system 270/8 with PE grating PG 9

**PE ground protection system with general building certification Z-40.22-579**

- can be used as a storage/filling station
- elements can be connected to form a comprehensive storage system

- rugged, removable PE grating
- connection components (accessories) permit the lining of surfaces of any size that are suitable as storage and transfilling stations

- sturdy PE drive-on ramp with integrated angle bracket for docking onto the PE sump, low gradient for easy loading of the floor elements
- PE grating and access ramp are non-slip

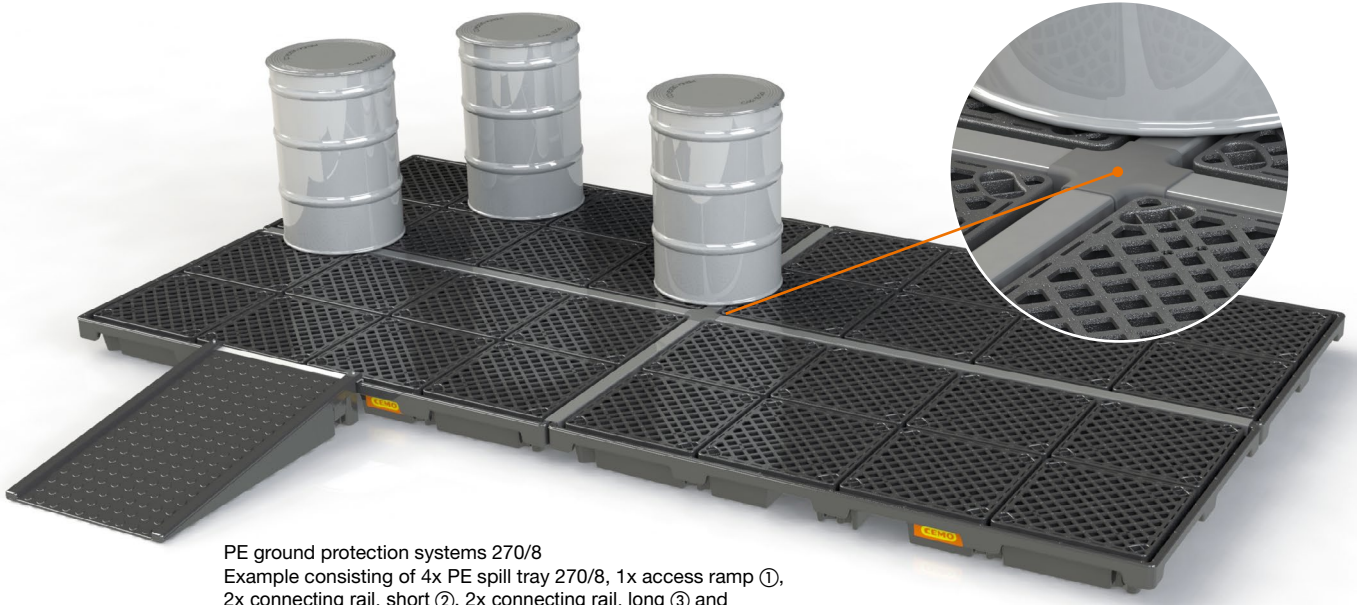



PE ground protection systems 270/8  
Example consisting of 4x PE spill tray 270/8, 1x access ramp ①, 2x connecting rail, short ②, 2x connecting rail, long ③ and 1x Cross connector ④



Description / Type	Overall dimensions cm (l x w x h)	Collection volume L	Ultimate load* kg	Weight approx. kg	with general building certification
					Order no.
PE ground protection systems 270/8 with PE grating	248 x 128 x 18	270	2400	44	11275

\* with an evenly distributed load

## ACCESSORIES FOR PE GROUND PROTECTION SYSTEMS 270/8

Description	Overall dimensions cm (l x w x h)	Order no.
① Access ramp for PE drum bunds 220/8	126 x 80 x 20	11282
②  ③ 	② Connecting rail, short for front connection ③ Connecting rail, long for longitudinal connection	11641 11642
④ 	Cross connector	11643



# Ground protection systems (steel) PG 9

Safety when handling water hazardous and flammable substances.

Modular matching elements allow the lining of large surfaces, which are suitable as storage and transfer stations.

- suitable for storage of water-polluting and flammable substances
- modular, matched elements
- with galvanised, removable grating
- available painted (RAL 5002, ultramarine blue) or galvanised

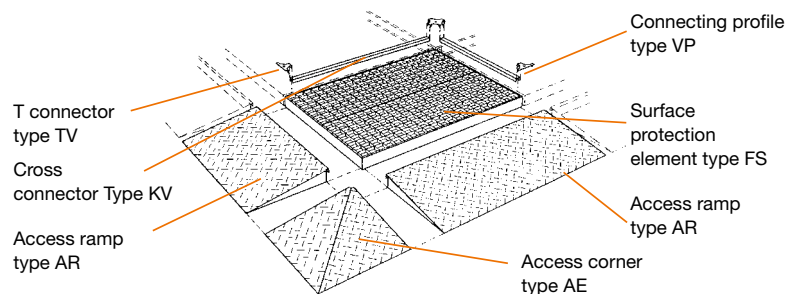
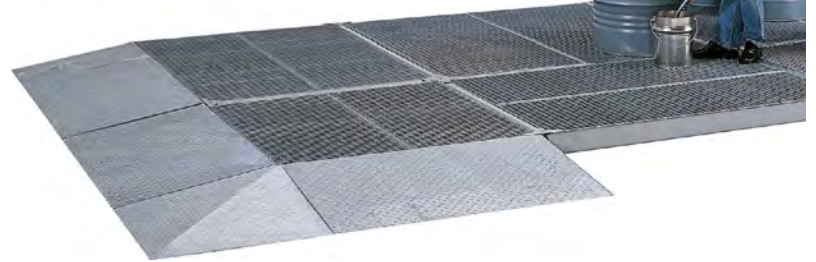

## SYSTEM ELEMENTS

Description / Type		External dimensions cm (l x w)	Height cm	Collection volume L	Capacity kg/m <sup>2</sup>	Wheel load kg	Weight approx. kg	Order no.
Ground protection	FS 55/13/13 galvanised	130 x 130	5.5	49	5000	450	106	11441
	FS 55/13/18 galvanised	130 x 180	5.5	69	5000	450	136	11442
	FS 55/13/28 galvanised	130 x 280	5.5	108	5000	450	223	11443
	FS 55/18/18 galvanised	180 x 180	5.5	96	5000	450	201	11444
	FS 108/13/13 galvanised	130 x 130	11	105	5000	450	112	11445
	FS 108/13/18 galvanised	130 x 180	11	146	5000	450	153	11446
	FS 108/13/28 galvanised	130 x 280	11	228	5000	450	233	11447
	FS 108/18/18 galvanised	180 x 180	11	220	5000	450	209	11448
Access ramp	AR13 galvanised	126 x 72	5.5				30	7407
	AR18 galvanised	176 x 72	5.5				42	7408
	AR28 galvanised	276 x 72	5.5				63	10619
	AE galvanised	72 x 72	5.5				21	7410
	AR13 galvanised	126 x 72	11				34	7411
	AR18 galvanised	176 x 72	11				46	7412
	AR28 galvanised	276 x 72	11				70	10620
	AE galvanised	72 x 72	11				23	7414

Manufactured to order. Delivery approx. 3-4 weeks. Galvanised version of ground protection elements upon request.

## FASTENING ELEMENTS

Description /Type		External dimensions mm (w x l)	Weight approx. kg	Order no.
VP13	galvanised	38 x 1280	2	7415
VP18	galvanised	38 x 1780	3	7416
VP28	galvanised	38 x 2780	5	10621
KV	galvanised	200 x 200	1	7418
TV	galvanised	200 x 100	1	7419

Manufactured to order. Delivery approx. 3-4 weeks.

# Drum racks

**Sump/spill pallets with general construction inspection certification no. Z-40.12-227 granted by DIBt-Berlin.**

Drum racks for approved and space-saving storage of barrels and other containers. All drum racks are completely hot-dip galvanised and have a corrosion

free GRP sump/spill pallet for long-term safe use.

Due to their absolute corrosion resistance, GRP sump/spill pallets can be placed directly on the ground.

The low installation height facilitates handling in the factory/ workshop.

The different rack models permit filling

over the projecting sump/spill pallet even for the most widely varying types of barrels and containers. The rack ensures optimum matching to the actual operating conditions.

Delivered in space-saving individual parts, easily and quickly assembled.

- ✓ quick and easy assembly
- ✓ universally applicable  
e.g. waste oil, lyes and acids
- ✓ corrosion-resistant
- ✓ high resilient shelves
- ✓ minimum inspection requirements,  
no additional inspection of  
sump/spill pallet bottom  
(compare steel sump/spill pallets)



Example:

**Drum rack type 540** has three grating shelves and six clip-in individual drum supports, which can be clipped in different positions in two shelves.

## ACCESSORIES



Sump/spill pallet supports for secure standing on uneven ground and to permit driving under the drum rack

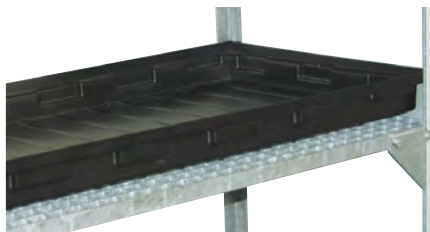

Accessory PE collection tray 40 L



Can holder for easy filling of small containers



Ball valve for quick and simple discharge



Rotating roller support for simple movement of drums



Drum supports for tilting drum for optimum emptying of 60 L drums

## Drum racks type 120 PG 9

2 shelves  
for up to two 60 L barrels

or

2 shelves  
for small containers

or

1 shelf  
for one 60 L barrel and  
1 shelf  
for small containers

GRP sump/spill pallet with  
65 L collection volume

drum supports

Application example:  
with steel grating for  
GRP sump/spill pal-  
let as 3rd shelf (see  
page 167)

Application example:  
with stackable barrel  
support as an extra  
shelf for a 60 L drum  
(see page 167)

Model 3  
Drum rack Type 120  
with GRP sump/spill  
pallet

### DRUM RACK TYPE 120 FOR SMALL CONTAINERS AND 60 L BARRELS

Description		Overall dimensions cm (l x w x h)	Heights of shelves in cm from ground	Weight approx. kg	Order no.
Type 1 sump/spill pallet 65 L					
	Model 1 with GRP sump/spill pallet ① with drum supports for 2 x 60 L barrels	45 x 82 x 131	63 / 115	18	7081
	Model 1 with steel sump/spill pallet ④ with drum supports for 2 x 60 L barrels	45 x 82 x 131	63 / 115	37	11481
	Model 2 with GRP sump/spill pallet ② with grating support for small containers	45 x 82 x 131	60 / 112	21	7639
	Model 2 with steel sump/spill pallet ⑤ with grating support for small containers	45 x 82 x 131	60 / 112	40	11482
	Model 3 with GRP sump/spill pallet ③ with drum and grating support for 1 x 60 L barrel and small containers	45 x 82 x 131	60 / 112	19	7640
	Model 3 with steel sump/spill pallet ⑥ with drum and grating support for 1 x 60 L barrel and small containers	45 x 82 x 131	60 / 112	38	11483

Accessories see page 167



# Drum racks type 360 and type 540 PG 9



Drum rack type 360 with GRP sump/spill pallet  
Application example: with can holder and steel grating as 3rd shelf



Drum rack type 540 with GRP sump/spill pallet  
Application example: with can holder and steel grating as 4th shelf



Drum rack type 540 with steel sump/spill pallet\*



\*certified under StawaR

Description	Overall dimensions cm (l x w x h)	Heights of shelves in cm from ground	Weight approx. kg	Order no.
<b>DRUM RACK TYPE 360 FOR SMALL CONTAINERS AND UP TO 6 X 60 L BARRELS</b>				
Drum rack type 360 with GRP sump/spill pallet 150 L (5113) with drum supports for 6 x 60 L barrels and/or small containers	132 x 80 x 130	69 / 117	60	7642
Drum rack type 360 with steel sump/spill pallet SW 2 (7583) with drum supports for 6 x 60 L barrels and/or small containers	132 x 80 x 130	36 / 69 / 117	115	10253
<b>DRUM RACK TYPE 540 FOR SMALL CONTAINERS AND UP TO 12 X 60 L BARRELS</b>				
Drum rack type 540 with GRP sump/spill pallet 150 L (5113) with drum supports for 6 x 60 L barrels and small containers	132 x 80 x 200	69 / 117 / 165	82	7734
Expansion unit for type 540 with GRP sump/spill pallet 150 L (5113) with drum supports for 6 x 60 L barrels and small containers	132 x 80 x 200	69 / 117 / 165	72	7855
Drum rack type 540 with steel sump/spill pallet SW 2 (7583) with drum supports for 6 x 60 L barrels and small containers	132 x 80 x 200	36 / 69 / 117 / 165	137	10254
Expansion unit for type 540 with steel sump/spill pallet SW 2 (7583) with drum supports for 6 x 60 L barrels and small containers	132 x 80 x 200	36 / 69 / 117 / 165	127	10255

Accessories see page 167



Combination of drum rack type 540 and expansion unit type 540



Combination of drum rack type 540 and hazardous substance rack 13/20 (see p. 170)

## Drum racks type 400 PG 9

2 shelves  
for up to four 60 L barrels  
or two 200 L barrels

or

1 shelf  
for small containers  
and 1 shelf  
for up to two 60 L barrels  
or one 200 L barrel



GRP sump/spill pallet with  
220 L collection volume



Model 2  
drum rack type 400

### DRUM RACK TYPE 400 FOR SMALL CONTAINERS AND UP TO 4 X 60 L BARRELS

Description

Type 400 with GRP sump/spill pallet 220 L (6882)	Overall dimensions cm (l x w x h)	Heights of shelves in cm from ground	Weight approx. kg	Order no.
 <p>Model 1 with barrel support for 2 x 60 L barrels or 1 x 200 L barrel</p>	99 x 128 x 84	62	41	7663
 <p>Model 2 with barrel support for 4 x 60 L barrels or 2 x 200 L barrels or 2 x 60 L drums and 1 x 200 L drum</p>	99 x 128 x 162	62 / 140	70	7664
 <p>Model 3 with barrel support for 2 x 60 L barrels or 1 x 200 L barrel and grating support for small containers</p>	99 x 128 x 162	62 / 139	82	7665

Accessories see page 167

## Drum rack type 800 PG 9

2 shelves  
for up to six 60 L barrels  
or four 200 L barrels

or

1 shelf for small  
containers and 1 storage  
level for barrels

or

1 shelf  
for barrels

GRP sump/spill  
pallet with 220 L  
containment capacity



Model 3  
drum rack type 800

drum supports

can holder  
(accessory)















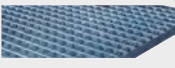

### DRUM RACK TYPE 800 FOR SMALL CONTAINERS AND UP TO 4 X 200 L BARRELS

Type 800 with GRP sump/spill pallet 220 L (6884)	Description	Overall dimensions cm (l x w x h)	Heights of shelves in cm from ground	Weight approx. kg	Order no.
	Model 1 with barrel supports for 2 x 200 L barrels	141 x 128 x 84	62	51	7670
	Model 2 with barrel supports for 4 x 200 L barrels	141 x 128 x 162	62 / 140	84	7671
	Model 3 with barrel supports for 2 x 200 L barrels and 3 x 60 L barrels	141 x 128 x 162	62 / 140	87	7672
	Model 4 for 2 x 200 L barrels and grating support for small containers	141 x 128 x 162	62 / 139	116	7673
	Model 5 with drum supports for 3 x 60 L barrels	141 x 128 x 84	62	54	7674
	Model 6 with drum supports for 6 x 60 L barrels	141 x 128 x 162	62 / 140	90	7675

Accessories see page 167



## Accessories for drum racks type 120 to type 800 PG 9

	for type	Description	Overall dimensions cm (l x d x h)	Heights of shelves in cm from ground	Weight approx. kg	Order no.
	400	Sump/spill pallet support (pair), sump/spill pallet forkliftable by forklift		15	7	7668
	800	Sump/spill pallet support (pair), sump/spill pallet forkliftable by forklift		15	10	7679
	400	Shelf for 1 x 200 L or 2 x 60 L drums	99 x 66 x 84	62	28	8326
	800	Shelf for 2 x 200 L drums	141 x 66 x 84	62	33	8328
	800	Shelf for 3 x 60 L drums	141 x 66 x 84	62	36	8329
	120	Steel grating for sump/spill pallet as 3rd shelf	42 x 80 x 3	24	6	7641
	360 540	Steel grating as 3rd (for type 360) or 4th shelf (for type 540)	130 x 62 x 3	21	18	6817
	360 540	Steel tray 20 L as 3rd (for type 360) or 4th shelf (for type 540)	130 x 62 x 5	21	19	7799
	360 540	PE collection tray 40 L as insert tray (acid-/alkali resistant, see page 149)	130 x 62 x 8	22	5	7871
	120	Stackable drum support, for an extra shelf for a 60 L drum (see page 154)	63 x 45 x 53	167	10	7741
	400	Grating level for small containers	99 x 125 x 84	62	40	8327
	360 540	Drum supports 3 pcs. per shelf			1	7800
	360 540	Drum supports "raising" 3 pieces for one shelf for optimum emptying of the 60 L drums			1	8254
	400 800	Rotating roller support for 200 L barrel (pair)		66	6	7669
	360 400 540 800	Edge border (4-part), galvanised for sideways insertion in the steel grating for securing storage material such as small containers, etc. from filling off				6990
	120 360 540	Can holder, galvanised, bearing surface 23 x 11 cm (w x d)			2	5917
	400 800	Can holder, galvanised, bearing surface 18.5 x 11 cm (w x d)			2	7727
	all	Discharge ball valve 1/2", nickel plated brass, angled 90° [PG 8]			1	3775
	all	Discharge ball valve 3/4", nickel plated brass, angled 90° [PG 8]			1	3776

# HazMat pallet racks with PE sumps PG 9

## HazMat pallet racks

These racks are ideal for storing drums on Euro pallets or chemical pallets and for IBC storage. They comply with the legal requirements for the storage of water-hazardous substances.

- several storage versions can be combined
- expandable
- simple plug-together assembly system
- suitable for storage of water-hazardous substances
- two shelves

**PE collection trays with General Construction Inspection Certification Z-40.22-579**



HazMat pallet racks 18/405 and 27/1100, including optional PE suspended rack sumps 18/230 and 27/230, see page 169

## HazMat pallet rack consisting of:

- two support frames
- two pairs of cross members
- two push-through prevention rails incl. bracket
- one PE rack floor tray

## Add-on rack consisting of:

- one support frame
- two pairs of longitudinal members
- two push-through prevention rails incl. bracket
- one PE rack floor sump



## HAZMAT PALLET RACKS AS A SET WITH PE RACK FLOOR TRAY

Description	Overall dimensions cm (l x w x h)	Shelf dimensions in cm (w x d)	Shelf load in kg	For number of pallets	Weight approx. kg	Collection volume L	Order no.
HazMat pallet rack 18/405 for drum storage	207 x 110 x 300	190 x 110	3850	2	132	405	11462
Add-on rack for HazMat pallet rack 18/405	199 x 110 x 300	190 x 110	3850	2	98	405	11463
HazMat pallet rack 22/520 for drum storage	247 x 110 x 300	230 x 110	3000	2	145	520	11464
Add-on rack for HazMat pallet rack 22/520	239 x 110 x 300	230 x 110	3000	2	111	520	11465
HazMat pallet rack 27/1100 for drum or IBC storage	287 x 110 x 300	270 x 110	3070	3	166	1100	11466
Add-on rack for HazMat pallet rack 27/1100	279 x 110 x 300	270 x 110	3070	3	132	1100	11467

## ACCESSORY HAZMAT PALLET RACK

Description	Order no.
 <p>Rack collision guard</p>	8202

# HazMat pallet racks with PE sump PG 9

## PE rack floor trays

with General Construction Inspection Certification Z-40.22-579

- for retrofitting to convert existing rack systems into HazMat pallet racks
- made of high-quality polyethylene (PE)
- high chemical resistance
- sump can be placed directly on the floor
- with integral forklift pockets for loading the racks with pallets or IBCs



## PE RACK FLOOR SUMPS

Description	Overall dimensions cm (l x w x h)	For number of pallets	Weight approx. kg	Collection volume L	Order no.
PE rack floor sump 18/405 for shelf dimensions 180 x 110 cm	178 x 132 x 28	2	18.2	405	11468
PE rack floor sump 22/520 for shelf dimensions 220 x 110 cm	218 x 132 x 28	2	22.5	520	11469
PE rack floor sump 27/1100 for shelf dimensions 270 x 110 cm	268 x 132 x 42	3	34	1100	11470

## PE suspended rack sumps

with General Construction Inspection Certification Z-40.22-579

- for retrofitting to convert existing rack systems into HazMat pallet racks
- made of high-quality polyethylene (PE)
- high chemical resistance
- the PE suspended rack sumps rest on the rack cross members and are held securely in place
- ideal for Euro pallets (120x80)
- loaded pallets can be placed directly on the sump
- a steel or PE grating is not required, but can be used if desired



PE suspended rack sump 18/230 for shelf dimensions 180 x 110 cm



PE suspended rack sump 27/230 for shelf dimensions 270 x 110 cm



## PE SUSPENDED RACK SUMPS

Description	Overall dimensions cm (l x w x h)	Internal depth cm	Shelf load in kg	For number of pallets	Weight approx. kg	Collection volume L	Order no.
PE suspended rack sump 18/230 for shelf dimensions 180 x 110 cm	178 x 130 x 23	95	2 x 600	2	20	230	11471
PE suspended rack sump 27/230 for shelf dimensions 270 x 110 cm	262 x 130 x 16.5	95	3 x 600	3	27.5	230	11472

## ACCESSORY FOR PE SUSPENDED RACK TRAY

Description	Overall dimensions cm (l x w x h)	Load capacity kg	Weight approx. kg	Order no.
Steel grating for PE suspended rack sump*	120 x 80 x 3	600	12.4	11269
PE grating for PE suspended rack sump*	120 x 80 x 6	600	8.5	10286

\*two required for PE suspended rack tray 18/230 and three for suspended rack sump 27/230



# Environmental / HazMat racks PG 9

## Environmental/HazMat rack 10/20 with general construction inspection certification no. Z-40.22-388

For storage of water-polluting substances in small containers up to 30 L capacity. The tray is completely galvanised and can be assembled without screws or tools. It has 5 shelf floors which can be positioned in mounting points that have 25 mm spacing and two 30 L, PE collection trays. Each level can support up to 200 kg.



## Environmental/HazMat rack 13/20

For storage of water-polluting substances in small containers up to 20 L capacity. It is completely hot-dip galvanised and equipped with a 20 L leak-tight spill tray base welded in accordance with StawaR (German guidelines for the requirements of steel container trays of capacity up to 1000 L) lowest shelf. Each level can support up to 200 kg.





Environmental/HazMat rack 10/20 with expansion rack (PE sump/spill pallet, accessory)

## ENVIRONMENTAL/HAZMAT RACK 10/20 FOR SMALL CONTAINERS

Description	Overall dimensions cm (l x w x h)	Weight approx. kg	Order no.
 Environmental/HazMat rack 10/20 for small containers	106 x 63 x 200	44	8091
 Expansion rack for environmental/HazMat rack 10/20	101 x 63 x 200	34	8092

## ENVIRONMENTAL/HAZMAT RACK 13/20 FOR SMALL CONTAINERS

Description	Overall dimensions cm (l x w x h)	Heights of shelves in cm from ground	Weight approx. kg	Order no.
 Environmental/HazMat rack 13/20 for small containers	132 x 63 x 200	16/69/117/165	92	7820
 Expansion rack for Environmental/HazMat rack 13/20	132 x 63 x 200	16/69/117/165	82	7856

## ACCESSORIES ENVIRONMENTAL/HAZMAT RACKS 10/20 AND 13/20

for type	Description	Overall dimensions cm (l x w x h)	Weight approx. kg	Order no.
10/20	PE collection tray 30 L as insert tray (acid-/alkali resistant)*	98 x 60 x 8.5	4	8076
13/20	PE collection tray 40 L as insert tray (acid-/alkali resistant)*	130 x 62 x 8	5	7871
10/20	Additional shelf floor for Environmental/HazMat rack 10/20	100 x 60 x 4	4	8093

\* see page 149

## Environmental/HazMat racks PG 9

### Space-saving storage for substances in all water-pollution classes

- galvanised steel for racks, sumps and gratings
- able to be accessed from both sides
- 200 kg weight limit per shelf
- 1600 kg floor wait limit per rack system
- height-adjustable shelves with grids of 25 mm

- additional wall fixing according to application (not essential)
- expandable storage capacity by increasing the base unit with expansion units
- quick plug-assembly of supplied components



Environmental/HazMat rack 10/5 (base unit) and 13/5 (as expansion unit) with removable grating (see accessories)



### Version with spill tray base:

- 4 shelves with spill tray base
- separated storage of different substances per shelf
- spill tray per shelf
- all shelves can have the full containment volume by using the removable grating (see accessories)

### Version with grating shelves:

- 4 shelves with grating
- 3 shelves with grating
- bottom shelf with spill tray
- bottom shelf can have the full containment volume by using a removable grating (see accessories)



Environmental/HazMat rack 13/5 (base unit) and 10/5 (expansion unit) with removable grating (see accessories)

## ENVIRONMENTAL/HAZMAT RACK 10/5 AND 13/5

Description	External dimensions cm (l x w x h)	Usable floor area cm (l x w)	Features	Containment volume L	Base unit	Expansion unit
					Order no.	Order no.
10/5 with spill tray bases	106 x 53.5 x 200	100 x 50	4 x shelf tray, galvanised	4 x 25	11181	11182
13/5 with spill tray bases	136 x 53.5 x 200	130 x 50	4 x shelf tray, galvanised	4 x 33	11183	11184
10/5 with grating levels	106 x 53.5 x 200	100 x 50	1 x shelf tray, 3 x grating, galvanised	1 x 25	11185	11186
13/5 with grating levels	136 x 53.5 x 200	130 x 50	1 x shelf tray, 3 x grating, galvanised	1 x 33	11187	11188

Note: An expansion unit is supplied without a frame on one side and can only be used in conjunction with the base field.

## ACCESSORIES FOR ENVIRONMENTAL/HAZMAT RACK 10/5 AND 13/5

Description	for type 10/5	for type 13/5
	Order no.	Order no.
Additional shelf spill tray	11189	11190
Additional grating as storage shelf	11191	11192
Reinforcing cross members (two) for shelf floor tray and grating as shelf	11365	11363
Removable grating for shelf tray	11193	11194
Wall fixing	11195	11195

# Workshop trolley PG 9

**Robust mobile workshop trolley for use in working and storage areas. Also ideal as a station for dispensing liquids and safely providing hazardous substances.**

**Three versions are available.**

- 3 mm thick steel spill trays tested according to German regulation StawaR
- optionally available with lockable storage space
- push handle for simple manoeuvring
- four castors, including two braked steering castors
- top spill tray shelf positioned at an ergonomic working height of 92 cm
- optional third spill tray shelf can be positioned at half height
- high-quality powder coating in light grey and orange

**Version 1: with spill tray shelves**

- two spill tray shelves with 89 x 59 cm base area
- spill tray shelf can be fixed at half height as necessary
- includes 1 x perforated plate insert, can be used for both spill tray shelves

**Version 2: with compartment**

- two spill tray shelves with 44 x 59 cm base area
- lockable door
- height-adjustable shelf inside (42 x 58 cm base area)
- storage area on top with non-slip mat
- includes 1 x perforated plate insert, can be used for both spill tray shelves

**Version 3: with drawers**

- two spill tray bases with 44 x 59 cm base area
- five drawers, jointly lockable
- storage area on top with non-slip mat
- includes 1 x perforated plate grating, can be used for both spill tray bases



**Version 1**  
Workshop trolley with spill trays



**Version 1**  
Workshop trolley with spill trays and additional spill tray base 20 litres



**Version 3**  
Workshop trolley with spill trays, drawers and additional spill tray base, 10 litres



**Version 2**  
Workshop trolley with spill trays, compartment and additional spill tray base 10 litres

Description	Dimensions cm (l x d x h)	Containment volume L	Weight approx. kg	Load capacity per level kg	Order no.
Workshop trolley with spill trays	99 x 61 x 92	2 x 20	58.8	75 / 150	11583
Workshop trolley with spill trays, <b>compartment</b> and anti-slip mat	99 x 61 x 92	2 x 10	56.2	75 / 180	11584
Workshop trolley with spill trays, <b>drawers</b> and anti-slip mat	99 x 61 x 92	2 x 10	86.2	75 / 180	11585

## ACCESSORIES FOR WORKSHOP TROLLEY

Description	Overall dimensions cm (l x d x h)	Weight approx. kg	Order no.
Additional spill tray 10 L	45 x 60 x 6	7.8	11586
Additional spill tray 20 L	90.5 x 60 x 6	14.8	11587
Perforated plate for spill trays 10 L	44 x 59 x 5.5	2.2	11588
Perforated plate for spill trays 20 L	89.5 x 59 x 5.5	3.6	11589
Anti-slip mat (for compartments and drawers)	45 x 60 x 0.5	0.8	11358



## Mobile hazardous material depot PG 9

### For moving directly to the working location

- base spill according to German regulation StawaR
- shelf at the topmost position
- body made from sheet steel painted in grey (RAL 7035)
- smooth-running, lockable roller shutter
- side faces with perforations for tool holding system
- four castors, including two braked steering castors
- push handle for simple manoeuvring
- delivered fully assembled and ready for immediate use
- delivery completely assembled



Mobile hazardous material depot with shelf, extending tray and floor tray 33 L

Roller shutter, closed



Description	System includes	Overall dimensions cm (b x t x h)	Weight approx. kg	Load-bearing capacity per shelf in kg	Order no.
Mobile hazardous material depot	1 x shelf 1 x extending tray 1 x floor tray 33 L (incl. perforated plate insert)	124 x 61 x 136	118	50	11394

### ACCESSORIES

Floor tray 66 L (incl. perforated plate insert)	110 x 55 x 12	28	-	11400
Additional extending tray	108 x 51 x 9	11	-	11398
Additional spill tray base (incl. perforated plate insert)	111 x 55 x 5	12	-	11395
Non-slip mat, suitable for extending tray or shelf	-	0.5	-	11397

Environmental/HazMat cabinets on page 174

## Hazardous material depot PG 9

**NEW**

### For use in buildings and for outdoor installation

- vents in the door for natural ventilation
- lockable doors against unauthorised access
- slight roof pitch for rain drainage
- certified drip tray according to German regulation StawaR
- 2-drum version with partition wall in the centre
- hazard warning labels enclosed for identification as a hazardous materials storage facility
- Accessory height-adjustable shelves (grid 25 mm) allow storage of canisters and trays
- ground clearance for optimum forkliftability
- drums can be stored with pump or funnel fitted
- delivery completely assembled



Hazardous material depot compact 220 for 2 drums with perforated shelf (accessory)

Hazardous material depot compact 220 for 1 drum



Description	Internal dimensions cm (l x w x h)	External dimensions cm (l x w x h)	Containment volume L	Weight approx. kg	Order no.
Hazardous material depot compact 220 for 1 drum	82 x 67 x 144	82 x 67 x 200	220	99	11699
Hazardous material depot compact 220 for 2 drums	167 x 67 x 144	170 x 70 x 180	220	162	11700

### ACCESSORY FOR HAZARDOUS MATERIAL DEPOT

perforated shelf	81 x 66 x 3	-	-	4.2	11701
------------------	-------------	---	---	-----	-------

## Environmental/HazMat cabinets PG 9

For the safe and proper storage of water-hazardous and environmentally hazardous substances in buildings pursuant to German technical regulation TRGS 510.

CEMO environmental cabinets are manufactured from quality sheet steel. All cabinets are certified due to the sump certification according to German Steel Sump Guideline (StawaR). Since the doors are lockable, access can be restricted to persons trained in handling hazardous substances. Also ideal for storage of pesticide. Not suitable for the storage of flammable substances in work areas.

The following applies to all environmental cabinets on this double page:

- floor bund conformant to StawaR in 3 mm-thick steel
- each shelf is a spill tray
- high-quality powder coating in grey (RAL 7035)
- lockable doors by means of a cylinder lock
- doors open to 180°
- vents in the doors for natural ventilation
- supplied fully assembled and ready for immediate use
- the cabinet top has a connection (NW75) for an external ventilation system
- hazard warning label included

**Environmental cabinet 5/10, 10/10, 5/20 & 10/20 and certified pursuant to StawaR**

4 sizes for maximising space

- all shelves are manufactured as galvanised sumps
- height-adjustable shelves, additional shelves available separately
- document pouch on inside of door



Environmental/HazMat cabinet 10/20



Environmental/HazMat cabinet 5/20



Environmental/HazMat cabinet 10/10



Environmental/HazMat cabinet 5/10



Green pesticide cabinets on page 178

### ENVIRONMENTAL/HAZMAT CABINETS 5/10, 10/10, 5/20 AND 10/20

Description	System includes: Floor tray, shelf tray	Overall dimensions cm (l x d x h)	Load capacity per level kg	Weight approx. kg	Order no.
Environmental/HazMat cabinet 5/10	1 x 30 L, 1 x 20 L	50 x 50 x 100	65	38	10999
Environmental/HazMat cabinet 10/10	1 x 30 L, 1 x 20 L	95 x 50 x 100	65	54	11000
Environmental/HazMat cabinet 5/20	1 x 30 L, 3 x 20 L	50 x 50 x 195	65	61	11001
Environmental/HazMat cabinet 10/20	1 x 30 L, 3 x 20 L	95 x 50 x 195	65	88	11002

### ACCESSORIES FOR ENVIRONMENTAL/HAZMAT CABINETS 5/10, 10/10, 5/20 AND 10/20

Description	for type	Weight approx. kg	Order no.
Shelf tray	5/10, 5/20	2.5	11005
Shelf tray	10/10, 10/20	4	11006
Perforated plate insert for shelf tray	5/10, 5/20	2.2	11007
Perforated plate insert for shelf tray	10/10, 10/20	3.2	11008
Perforated plate insert for floor tray	5/10, 5/20	2.5	11060
Perforated plate insert for floor tray	10/10, 10/20	3.5	11061

# Environmental/HazMat cabinets PG 9

① **Environmental cabinet with sliding door and certified pursuant to StawaR**

- ideal for tight spaces
- each sliding door is mounted on rollers and can therefore be operated with one hand
- all shelves are manufactured as spill trays
- height-adjustable shelves
- all spill trays galvanised

② **Environmental cabinet with fully extending drawers and certified pursuant to StawaR**

- removable galvanised shelf trays enable best access to all stored containers and tanks
- with interlock protection as standard so that not more than one sliding shelf can be open simultaneously
- all trays galvanised

③ **Environmental cabinet designed as a canister cabinet and certified pursuant to StawaR**

- filling directly from the canister store (up to 15 canisters)
- the floor tray can be pulled out at the same time as the canister shelf to catch any spillage during filling
- the canister holder is suitable for most popular designs
- with interlock protection as standard so that the shelf tray cannot be open at the same time as more than one canister level
- all internals painted in RAL 7035
- shelf tray galvanised



② Environmental/HazMat cabinet 10/20 with fully extending drawers



Mobile HazMat depot on page 173.



① Environmental/HazMat cabinet 15/20 with sliding doors



③ Canister cabinet 10/20 (canisters not included)

Fans on pages 192-193

Description	System includes	Overall dimensions cm (l x d x h)	Load capacity per level kg	Weight approx. kg	Order no.
Environmental cabinet 10/20 with sliding doors	1 x Floor tray 30 L, 3 x Shelf tray @ 20 L	100 x 50 x 195	65	95	11011
① Environmental cabinet 15/20 with sliding doors	2 x Floor tray @ 30 L, 6 x Shelf tray @ 20 L, centre divider	150 x 50 x 195	65	150	11012
Environmental cabinet 10/20 with fully extending drawers	1 x Floor tray 30 L, 3 x Shelf tray @ 20 L	95 x 50 x 195	70	108	11009
② Environmental cabinet 12/20 with fully extending drawers	1 x Floor tray 39 L, 3 x Shelf tray @ 20 L	120 x 50 x 195	70	120	11010
③ Canister cabinet 10/20	1 x Floor tray 30 L, 1 x Lower shelf, 3 x Canister shelves	100 x 55 x 195	Canister shelf: 70 Lower shelf: 45	125	11014



# Environmental/HazMat cabinet 13/20 PG 9

For the safe and proper storage of water-hazardous and environmentally hazardous, non-flammable substances in buildings pursuant to TRGS 510



The frame of this environmental cabinet is based on drum rack 540, forming a particularly sturdy overall package.

The cabinet is available in two versions.

- hot-dip galvanised frame and grating shelves
- high-quality powder coating in grey (RAL 7035)
- vents at the top and bottom of the doors for natural ventilation
- document pouch on inside of door
- hazard identification labels included
- load bearing capacity up to 200 kg per shelf
- 600 mm shelf depth allows horizontal storage of 60 L drums including tap for version 1



GRP sump with certification



Version ① with GRP sump 150 L



Version ① with GRP sump 150 L



Version ② with spill tray base 20 L

Version ①:

**Environmental cabinet 13/20 with GRP sump**

- collection volume 150 litres with General Construction Inspection Certification Z-40.12-227

Version ②:

**Environmental cabinet 13/20 with spill tray**

- bottom shelf as seamlessly welded steel spill with 20 litre collection volume

The cabinet is delivered unassembled.

Description	Kit includes	Overall dimensions cm (l x w x h)	Weight approx. kg	Order no.
① Environmental/HazMat cabinet 13/20 with GRP sump	4x gratings 1x GRP sump 150 L cabinet lining	132 x 80 x 200	202	7954
② Environmental/HazMat cabinet 13/20 with spill tray base	3x gratings 1x spill tray base 20 L cabinet lining	132 x 63 x 200	204	7956

## ACCESSORIES

Description	Overall dimensions cm (l x w x h)	Weight approx. kg	Order no.
PE sump 40 L as insert tray (acid-/alkali resistant)*	130 x 62 x 8	5	7871
Three drum supports for one shelf for version 1	130 x 62 x 8	1	7800

\* see page 149

You can find mobile cabinet solutions on page 173.

# Drum cabinet 14/20 PG 9

For the safe and proper storage of drums containing water-hazardous and environmentally hazardous, non-flammable substances in buildings according to German regulation TRGS 510

60 and 200 litre drums can be safely stored in this drum cabinet. The cabinet is large enough for you to work with a hand pump or handle the drums. The additional spill tray base at the top can accommodate small containers.

### Drum cabinet 14/20

- high-quality powder coating in grey (RAL 7035)
- lockable doors by means of a cylinder lock
- vents in the doors for natural ventilation
- the cabinet top has a connection (NW75) for an external ventilation system
- document pouch on inside of door
- hazard warning label included

#### Version ① with large, certified collection tray:

- floor tray made of steel or PE, both with grating
- additional spill tray at top (height adjustable, 25 mm grid)
- supplied fully assembled and ready for immediate use

#### Version ② with drum rack type 360 and certified collection tray:

- base made of steel, PE or GRP
- with drum supports for 6 x 60 L drums
- optional third shelf using grating



Drum cabinet with steel base for upright 200 litre drums



Drum cabinet with drum rack type 360 inside for horizontal 60 litre drums, steel grating as as third shelf (see accessories), GRP base

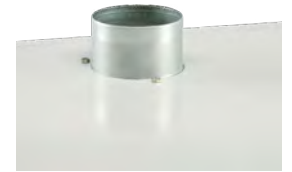

Connection option (NW75) for external ventilation system



Description	System includes:	Overall dimensions cm (l x w x h)	Weight approx. kg	Order no..
① Drum cabinet 14/20 with steel sump	1 x spill tray 30 L 1 x steel floor tray 210 L, incl. galvanised steel grating	140 x 84 x 195	150	11566
① Drum cabinet 14/20 with PE sump	1 x spill tray 30 L, 1 x PE floor tray 250 L, incl. PE grating	140 x 84 x 195	125	11571
① Drum cabinet 14/20 with PE sump	1 x spill tray 30 L, 1 x PE floor tray 250 L, incl. galvanised steel grating	140 x 84 x 195	128	11572
② Drum cabinet 14/20 with drum rack and steel sump	1 x drum rack type 360, incl. 6 x drum supports, 1 x steel floor tray 65 L	140 x 84 x 195	165	11569
② Drum cabinet 14/20 with drum rack and PE sump	1 x drum rack type 360, incl. 6 x drum supports, 1 x PE floor tray 120 L	140 x 84 x 195	145	11568
② Drum cabinet 14/20 with drum rack and GRP sump	1 x drum rack type 360 incl. 6 x drum supports, 1 x GRP sump 150 L	140 x 84 x 195	149	11567

## ACCESSORIES

Description	Overall dimensions cm (l x w x h)	Weight approx. kg	Order no.
Steel grating as third shelf for drum rack type 360	130 x 62 x 3	18	6817
Three drum supports for steel grating for drum rack type 360	-	1	7800
Spill tray 30 L as additional shelf	132 x 46 x 5	8.5	11573

# Pesticide cabinets PG 9

For the safe and proper storage of pesticides in buildings pursuant to TRGS 510

Pesticides are useful but, in the wrong hands or if released unintentionally, they can cause great harm to people and the environment due to the water hazard they pose. These substances can be safely stored behind locked doors and on trays in CEMO pesticide cabinets. The cabinets are suitable for the storage of non-flammable substances in work areas.

**Pesticide cabinets 5/10, 10/10, 5/20 and 10/20**

**certified pursuant to StawaR:**

- four sizes for different storage quantities
- high-quality powder coating in green (RAL 6011)
- floor tray (30 litres) pursuant to StawaR, made of 3 mm thick steel
- all shelves are manufactured as galvanised trays
- height-adjustable shelves (25 mm grid)
- see accessories for further spill tray bases as additional shelf
- lockable doors by means of a cylinder lock
- doors open to 135°
- vents in the doors for natural ventilation
- delivered fully assembled and ready for immediate use
- document pouch on inside of door
- hazard warning label included

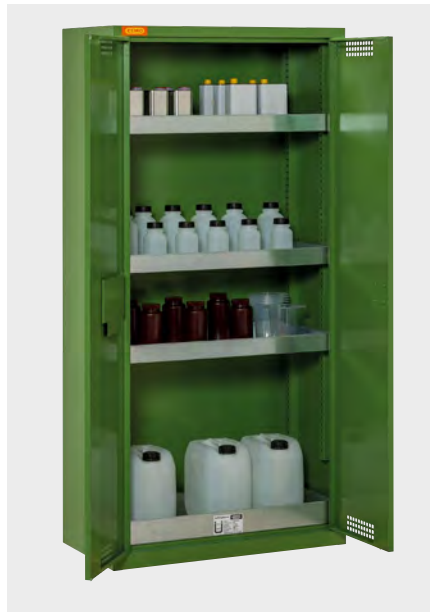

Pesticide cabinet 10/20



Pesticide cabinet 5/20



Pesticide cabinet 10/10



Pesticide cabinet 5/10 with perforated plate insert (see accessories)

Description	System includes: Spill tray base, floor tray	Overall dimensions cm (l x w x h)	Load capacity per shelf kg	Weight approx. kg	Order no.
Pesticide cabinet 5/10	1 x 20 L 1 x 30 L	50 x 50 x 100	50	29	11390
Pesticide cabinet 10/10	1 x 20 L 1 x 30 L	95 x 50 x 100	50	50	11391
Pesticide cabinet 5/20	3 x 20 L 1 x 30 L	50 x 50 x 195	50	56	11392
Pesticide cabinet 10/20	3 x 20 L 1 x 30 L	95 x 50 x 195	50	87	11393

## ACCESSORY

Description	for type	Weight approx. kg	Order no.
Spill tray base (20 litres)	5/10, 5/20	2.5	11005
Spill tray base (20 litres)	10/10, 10/20	4	11006
Perforated plate insert for spill tray base (20 litres)	5/10, 5/20	2.2	11007
Perforated plate insert for spill tray base (20 litres)	10/10, 10/20	3.2	11008
Perforated plate insert for floor tray (30 litres)	5/10, 5/20	2.5	11060
Perforated plate insert for floor tray (30 litres)	10/10, 10/20	3.5	11061



## PE environmental cabinets PG 9

### For storage of environment- and water-hazardous liquids

- suitable for aggressive media (e.g. acids & lyes)
- lockable swing doors
- integrated bund
- shelves made of resistant stainless steel
- only for indoor use
- ideal for storing small quantities
- polyethylene body manufactured in single-piece by rotation moulding



PE environmental cabinet S (Small) with storage in swing door and storage area on top



For outdoor storage:  
PE hazardous material depot  
on page 182

PE environmental cabinet L (Large)  
installed on optional, forkliftable sump  
(see accessory)



PE environmental cabinet M  
(Medium)

Description	External dimensions cm (l x w x h)	Internal dimensions cm (l x w x h)	Collection volume L	Weight approx. kg	Load capacity per shelf kg	Order no.
PE Environmental Cabinet S	60 x 47 x 85	58 x 38 x 20	18	19	15	11196
PE Environmental Cabinet M	97.5 x 52 x 118	95 x 41 x 31	47	38	50	11197
PE Environmental Cabinet L	99 x 50 x 166	97 x 41 x 31	28	53	50	11198

### ACCESSORY

Separate sump for PE Environmental Cabinet L	103 x 53 x 17	-	40	7	-	11199
--	---------------	---	----	---	---	-------

# Storage of hazardous substances outdoors

It is not always possible for businesses to store hazardous substances indoors. Sometimes it is recommended to reduce risk by storing hazardous substances outdoors in suitable containers. One needs to distinguish between storage containers without fire protection features (Safety Storage Containers (SRC) and hazardous substance depots) and those with fire-

resistant features (F90 fireproof container). When storing flammable substances, EX-protective equipment is generally required because a potentially explosive zone can be expected. In principle, the hazardous substances store should be fitted with a liquid-tight sump that should be certified.

The collection volume of a hazardous substance store must be capable of containing 10% of the total volume of liquids stored, or the volume of the largest container (e.g. drum or IBC). Please note: there are different regulations in water protection areas, if storage is permitted there

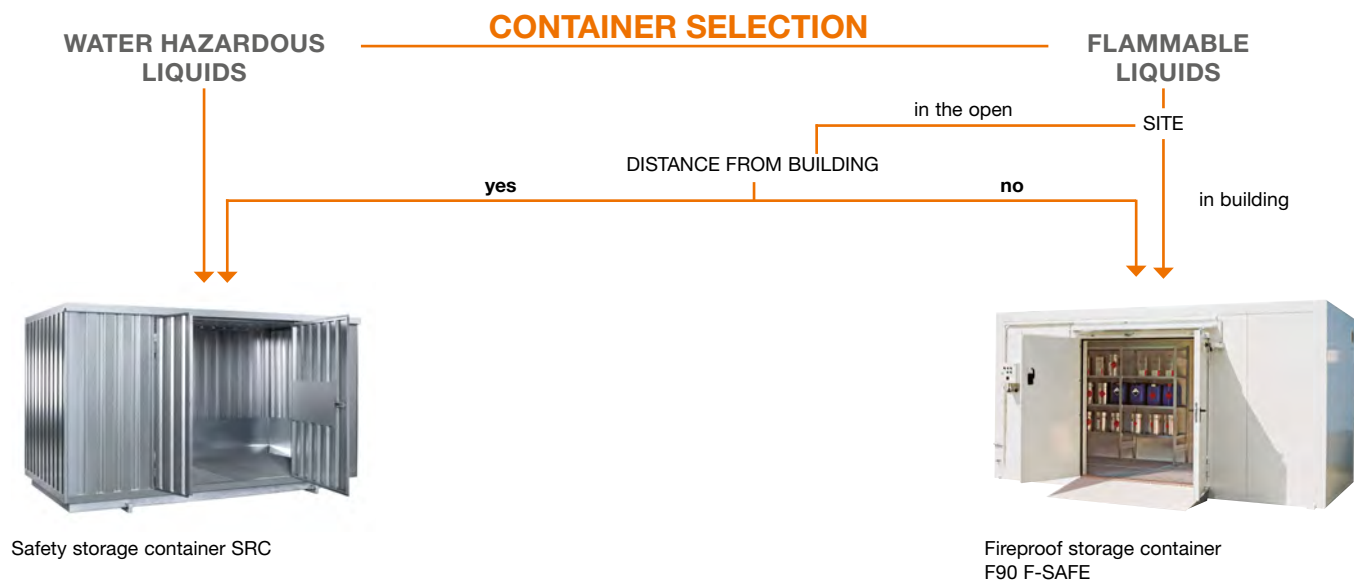

## SAFE DISTANCES

When **flammable liquids** are stored with out fireproof storage facilities, a safety distance must be maintained. This distance depends on the quantity to be stored in accordance with **TRGS (Technical Rule for Hazardous Substances) 510, Annex 5, Nr. 4, para. 2.:**

Combined stored volume <b>less than 200 kg:</b>	<b>3 metres</b>
Combined stored volume <b>between 200 kg and 1000 kg:</b>	<b>5 metres</b>
Active storage (see below) or combined stored volume <b>more than 1000 kg:</b>	<b>10 metres</b>

Alternatively, either fire-resistant building exterior walls (F90 in accordance with DIN 4102) or fire-resistant components between buildings and hazardous material storage in specified height and width would be sufficient, but in practice this occurs in very few cases. However, if a hazardous materials store is to be erected directly against a building, an F90 Fire proof container in fireproof construction is required.

## ACTIVE AND PASSIVE STORAGE OF FLAMMABLE LIQUIDS

1. Passive storage is when storage takes place in tightly closed containers. During the storage the containers may not be emptied or filled containers, even opening for other purposes is prohibited. Generally natural ventilation is sufficient.
2. Active storage refers to those storage situations in which the containers are opened for dispensing or refilling. Mechanical ventilation is mandatory in these cases. An exception can be made for small hazardous substance stores (observe risk assessment).

Description	Passive storage	Active storage
Safety distance available	SRC (Depot) Natural ventilation (0.4 times air change)	SRC (Depot) Mechanical ventilation (5 times air change)
No safety distance possible	F 90 fireproof container Mechanical ventilation (5 times air change)	F 90 fireproof container Mechanical ventilation (5 times air change)

## Hazardous material depot (steel) PG 9

- can be installed outdoors due to weather-resistant coating (similar to RAL7035)
- certified according to German regulation StawaR for the storage of water-hazardous (WGK 1-3) and flammable liquids (H224-226)
- cover can be held open as required by means of gas struts
- vents for natural ventilation
- doors can be locked to prevent unauthorised access
- ground clearance to allow the depot to be forkliftable
- space to accommodate chemical and Euro pallets
- supplied fully-assembled
- hazard warning label included for identification as a hazardous material storage facility
- horizontal drum storage possible with installation of drum rack (optional accessory) with 2 shelves for 2 x 200 L or 3 x 60 L drums per shelf
- additional shelves for canisters etc. available with the small container rack (optional accessory)
- for the storage of flammable liquids please note the safety distances from buildings specified in the regulations TRGS 510, no. 12.4.1 (2).



Wide-opening doors for easy access



Hazardous material depot 400 with optional drum rack



Hazardous material depot 320 with optional small container rack

Description	Dimensions cm (l x w x h)	Collection volume L	Capacity	Weight approx. kg	Order no.
Steel hazardous material depot 320	150 x 120 x 189.5	320	2 x 200 L / 6 x 60 L	209	11015
Steel hazardous material depot 400	150 x 150 x 189.5	400	4 x 200 L / 9 x 60 L	250	11016

### ACCESSORIES FOR STEEL HAZARDOUS MATERIAL DEPOT

Description	Dimensions cm (l x w x h)	Order no.
Drum shelf for steel hazardous material depot, horizontal drum storage, galvanised design, per shelf either 2 x 200 L drums or 3 x 60 L drums	135 x 52 x 90	11017
Small container shelf for steel hazardous material depot, 3 spill trays, galvanised design, up to 4 height-adjustable shelves	135 x 61 x 135	11018

Further hazardous material depots see page 173.



# PE hazardous material depot PG 9

## with General Construction Inspection Certification Z-40.22-591

- for use outdoors and indoors
- made of high-quality polyethylene (PE)
- high chemical resistance
- lockable with sturdy stainless steel bar lock
- with document pouch on inside of door
- with integral forklift pockets for loading with pallets or IBCs
- ideal for Euro pallets (120x80), industrial pallets (120x120), plastic pallets of similar size or IBCs

- loaded pallets or IBCs can be placed directly into the depot
- a steel or PE grating is not required, but can be used if required on PE hazardous material depot 220/2
- PE hazardous material depot 1100/1 is fitted with a separate, sturdy stand
- the stand is already integrated in the housing with PE hazardous material depot 220/2
- door opens to 270° for stand-alone installation
- door opens to approx. 180° for serial installation

- doors can be latched at increments of 90°
- integrated rain gutter at top of door opening
- domed roof withstands higher snow loads
- option for fitting interior lighting
- cable duct option on the rear wall



PE hazardous material depot 220/2 with Euro pallet and two drums



PE hazardous material depot 220/1 with industry pallet and four drums



PE hazardous material depots 220/2 and 1100/1

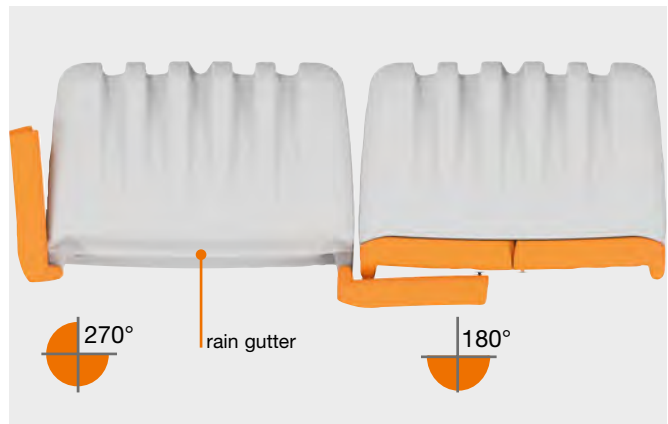

Door opening angle

Description	External dimensions cm (l x w x h)	Internal dimensions cm (l x w x h)	Load capacity kg	Collection volume L	Quantity 200 L drums	Quantity IBCs	Weight approx. kg	Order no.
PE hazardous material depot 220/2	160 x 114 x 198	127 x 94 x 153	600	220	2	-	100	11550
PE hazardous material depot 1100/1	160 x 167 x 228	127 x 147 x 149	1500	1100	4	1	170	11551

## PE hazardous material depot PG 9



PE hazardous material depot 220/2 with drum rack type 360, steel grating as third shelf and steel grating as filling area



Wind load protection



PE hazardous material depot 1100/1 with IBC

### ACCESSORIES FOR PE HAZARDOUS MATERIAL DEPOT

Description	Overall dimensions cm (l x w x h)	Weight approx. kg	Order no.
Steel grating for PE hazardous material depot 220/2	120 x 80 x 3	12.4	11269
PE grating for PE hazardous material depot 220/ 2	120 x 80 x 6	8.5	10286
Drum rack type 360 for PE hazardous material depot 220/2	132 x 63 x 130	51	7643
Steel grating as third shelf for drum rack type 360	130 x 62 x 3	21	6817
Steel grating as filling area for PE hazardous material depot 220/2	150 x 27 x 3	3	11549
Interior lighting with motion sensor and battery (non-ex rated) for PE hazardous material depots 220/2 and 1100/1	-	-	10378
Wind load protection for PE hazardous material depot 220/2 and 1100/1	-	-	11360

NEW

## HazMat collection station PG 9

**Hazardous substance collection stations from glass fibre reinforced plastic (GRP)**

**with General Construction Inspection Certification Z-40.12-228 granted by DIBt-Berlin**

offer centralised, safe storage for a variety of containers and liquids. The GRP sump

with splash protection wall is suitable for storage of liquids of all the water-polluting classes.

The wide opening lockable lid with gas struts allows easy loading/unloading and allows outdoor use – station has galvanised floor frame with grating.



### GRP HAZARDOUS SUBSTANCE COLLECTION STATION

Description	Surface area cm (l x w)	Height cm	Weight approx. kg	Order no.
Collection station with grating floor for outdoor installation (with lid), with 200 L containment volume	150 x 85	211	85	3412

Drum stand as accessory item on page 167

# Safety storage containers PG 9

This accessible container offers a compact solution for storage of a variety of hazardous materials. By the modular principle, this can be supplied in a variety of sizes and can be tailored to individual demands on site.

Surface area coverage from 2–42 m<sup>2</sup>



SRC 5.1W  
with 2 swing doors fitted to long side







Storage for  
plant pesticide  
(example painted green)

- ✓ Fully-assembled model
- ✓ Galvanised sheet steel  
Alternative: Galvanised and painted (RAL 5002 ultramarine blue, other colours available on request)
- ✓ Wall and roof elements from galvanised trapeze profile corrugated sheet steel
- ✓ Floor sections made as hot dipped galvanised steel sump floor.
  - resistant to chemicals according to Chemical compatibility guide DIN 6601
  - steel S235JR according to EN 10025
- ✓ 100 mm ground clearance
- ✓ Floor grating removable (load limit 1000 kg/m<sup>2</sup>)
- ✓ Large, single swing door (width 1240 mm)
- ✓ Traversable roof (designed to withstand 125 kg/m<sup>2</sup> snow load)
- ✓ drainage via interior gutters
- ✓ Spill guards on walls to protect against spills
- ✓ Door handles inside and outside



SRC 3.1W  
with door on narrow side

## FOR EVERY APPLICATION THE CORRECT CONTAINER CONFIGURATION

Type series	Icon	Description	Features	Example storage situation:
<b>SRC-W</b>		Storage of water-polluting liquids (WGK [water hazard class] 1-3)	<ul style="list-style-type: none"> <li>✓ Sump/spill pallet, walls and roof made of sheet steel</li> </ul>	Chemicals, water-polluting liquids
<b>SRC-N</b>		Storage of combustible and flammable liquids (WGK 1-3, H224-226)	<ul style="list-style-type: none"> <li>✓ Sump/spill pallet, walls and roof made of sheet steel</li> <li>✓ Perforations for natural ventilation (min. 0.4 air changes guaranteed)</li> </ul>	Fuel, petrol, oils, solvents
<b>SRC-TB</b>		Storage of temperature-sensitive, water-polluting liquids (WGK [water hazard class] 1-3)	<ul style="list-style-type: none"> <li>✓ Sump/spill pallet made of sheet steel</li> <li>✓ Walls and roof made of thermal insulation material (building material class B1: flame retardant)</li> </ul>	Pesticides, cleaning agents, chemicals, housing for dosing systems
<b>SRC-TA</b>		Storage of temperature-sensitive, flammable liquids (WGK 1-3, H224-226)	<ul style="list-style-type: none"> <li>✓ Sump/spill pallet made of sheet steel</li> <li>✓ Walls and roof made of thermal insulation material (building material class A1: non-combustible)</li> </ul>	Sensitive paints and varnishes

\* Multi-module containers from size 4.x are delivered in individual modules



# Safety storage containers PG 9

## STORAGE OF SUBSTANCES HAZARDOUS TO WATER (WGK [WATER HAZARD CLASS] 1-3):

Safety storage containers can be installed both indoors and outdoors.

Observe official requirements for larger storage quantities, in particular for WGK 3 (highly hazardous to water).

## STORAGE OF FLAMMABLE SUBSTANCES (H224-226):

### Normal case: passive storage

Four fundamental specific features must be taken into account here:

- The prescribed safety distance between material and buildings is maintained
- Sufficient ventilation is guaranteed
- The electrical equipment is explosion-proof and the container is earthed
- For versions with thermal insulation: only type series TA

If the spatial situation on the property does not permit a safety distance, an F90 fireproof storage unit with DIBt certification must be used.

See the detailed explanation of the regulations on page 180.

### Special feature: active storage

e.g. decanting, removing, filling, etc. into and from drums, IBCs and small containers

In addition to the technical requirements for passive storage, the container must imperatively have technical ventilation (forced ventilation) for 5 times air exchanges. We also recommend exhaust air monitoring of the ventilation system for maximum safety.

## EQUIPMENT OPTIONS (STANDARD OR OPTIONAL)

### Natural ventilation

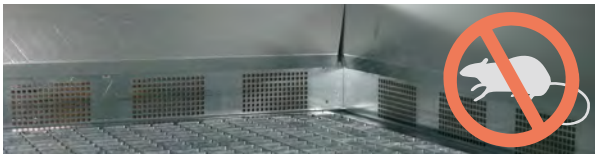

Min. 0.4 times air change rate confirmed by expert. Micro-perforation protects against penetration by small animals and rodents.

### Mechanical ventilation



Forced ventilation for 5 times air changes.

### Thermal insulation



For protection against frost and cold. Dependent on the storage medium in building material A1 or B1. Frequently used in conjunction with heating and ventilation (for accessories see page 188).

### Grating

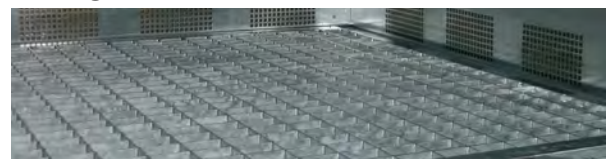

In addition to the standard grid, a closer-meshed grating with better lift truck access is also available if required.

### Single or double-wing doors



Single-wing door already in place creates an opening of 1240 cm (e.g. for chemical pallets), two-lead version provides significantly greater opening.

### Sliding door



Convenient access. No slamming in the wind compared to winged doors. Not possible for thermo-insulated containers.

# Safety storage containers PG 9

## CONTAINER DESIGNATION: MODULAR DESIGN SYSTEM

**FIGURE 1:** Module depth or width of the basic size (rough guideline value)

**FIGURE 2:** Number of assembled modules

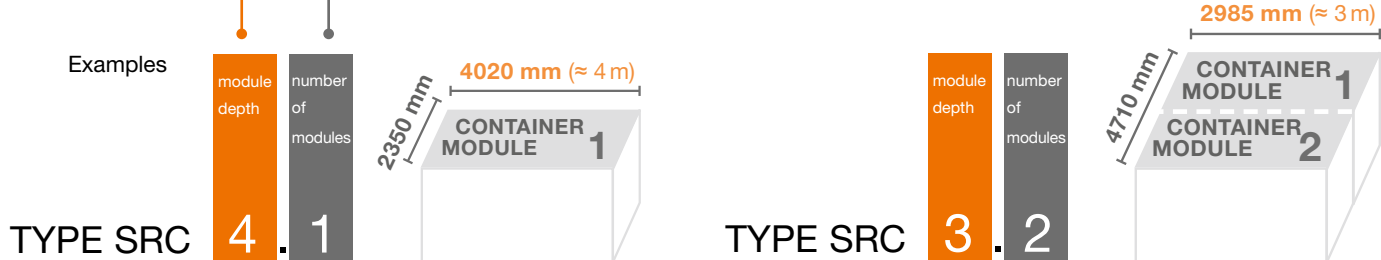

### TYPE SERIES SRC W FOR WATER POLLUTING SUBSTANCES/HAZMAT



Description	External dimensions cm (l x w x h)	Weight approx .kg	Collection volume in L	Galvanised model		Galvanised and painted	
				Position of door		Position of door	
				Long side Order no.	Narrow side Order no.	Long side Order no.	Narrow side Order no.
Type SRC 1.1W	235 x 91.5 x 241	230	300	8043	–	8210	–
Type SRC 2.1W	235 x 195 x 241	440	630	8044	8743	8211	8752
Type SRC 3.1W	298.5 x 235 x 241	650	1000	8744	8045	8753	8212
Type SRC 3.2W	471 x 298.5 x 241	1180	2 x 1000	8745	8209	8754	8213
Type SRC 3.3W	705 x 298.5 x 241	1710	3 x 1000	8746	8749	8755	8758
Type SRC 4.1W	402 x 235 x 241	830	1000	8747	8750	8756	8759
Type SRC 5.1W	505.5 x 235 x 241	980	1000	8748	8751	8757	8760
Type SRC 6.1W	609 x 235 x 241	1300	1000	10528	10529	10530	10531



Exception:  
Only in con-  
junction with  
technical  
ventilation  
(optional,  
see acces-  
series)

Standard sizes 4.2, 5.2, 6.2 and 6.3 on request. | On delivery: Unloading of the goods by the customer

### TYPE SERIES SRC TB FOR WATER POLLUTING SUBSTANCES/HAZMAT WITH THERMAL INSULATION



Description	External dimensions cm (l x w x h)	Weight approx.kg	Collection volume in L	Galvanised model		Galvanised and painted	
				Position of door		Position of door	
				Long side Order no.	Narrow side Order no.	Long side Order no.	Narrow side Order no.
Type SRC 1.1TB	235 x 91.5 x 245	405	300	8214	–	8218	–
Type SRC 2.1TB	235 x 195 x 245	700	630	8215	8761	8219	8764
Type SRC 3.1TB	298.5 x 235 x 245	990	1000	8762	8216	8765	8220
Type SRC 3.2TB	471 x 298.5 x 245	1725	2 x 1000	8763	8217	8766	8221

All standard sizes of the SRC-W type series also with TB insulation. | On delivery: Unloading of the goods by the customer

### TYPE SERIES W ST WITH SLIDING DOOR FOR WATER POLLUTING SUBSTANCES/HAZMAT



Description	External dimensions cm (l x w x h)	Door position on wall side	Weight approx. kg	Collection volume L	Galvanised	Galvanised and painted
					Order no.	Order no.
Type SRC 3.1W ST	298.5 x 237 x 241	298.5	700	1000	8767	8772
Type SRC 3.2W ST	473 x 298.5 x 241	298.5	1230	2 x 1000	8768	8773
Type SRC 3.3W ST	707 x 298.5 x 241	298.5	1760	3 x 1000	8769	8774
Type SRC 4.1W ST	402 x 237 x 241	402	880	1000	8770	8775
Type SRC 5.1W ST	505.5 x 237 x 241	505.5	1020	1000	8771	8776
Type SRC 6.1W ST	609 x 237 x 241	609	1350	1000	10532	10533

Further standard sizes on request. | On delivery: Unloading of the goods by the customer

# Safety storage containers PG 9

## TYPE SERIES SRC N WITH NATURAL VENTILATION



Description	External dimensions cm (l x w x h)	Weight approx. kg	Collection volume in L	Galvanised model		Galvanised and painted	
				Position of door		Position of door	
				Long side Order no.	Narrow side Order no.	Long side Order no.	Narrow side Order no.
Type SRC 1.1N	235 x 91.5 x 241	230	300	10339	-	10340	-
Type SRC 2.1N	235 x 195 x 241	440	630	10341	10342	10343	10344
Type SRC 3.1N	298.5 x 235 x 241	650	1000	10345	10346	10347	10348
Type SRC 3.2N	471 x 298.5 x 241	1180	2 x 1000	10349	10350	10351	10352
Type SRC 3.3N	705 x 298.5 x 241	1710	3 x 1000	10353	10354	10355	10356
Type SRC 4.1N	402 x 235 x 241	830	1000	10357	10358	10359	10360
Type SRC 5.1N	505.5 x 235 x 241	980	1000	10361	10362	10363	10364
Type SRC 6.1N	609 x 235 x 241	1300	1000	10534	10535	10536	10537

Standard sizes 4.2, 4.3, 5.2, 5.3, 6.2 and 6.3 on request! | On delivery: Unloading of the goods by the customer

## TYPE SERIES SRC TA WITH THERMAL INSULATION FOR FLAMMABLE LIQUIDS



Description	External dimensions cm (l x w x h)	Weight approx. kg	Collection volume in L	Galvanised model		Galvanised and painted	
				Position of door		Position of door	
				Long side Order no.	Narrow side Order no.	Long side Order no.	Narrow side Order no.
Type SRC 1.1TA	235 x 91.5 x 247	440	300	11215	-	11216	-
Type SRC 2.1TA	235 x 195 x 247	740	630	11217	11218	11219	11220
Type SRC 3.1TA	298.5 x 235 x 247	1050	1000	11221	11222	11223	11224
Type SRC 3.2TA	471 x 298.5 x 247	1820	2x1000	11225	11226	11227	11228

All standard sizes of the SRC-W type series also with TA insulation. | On delivery: Unloading of the goods by the customer

## TYPE SERIES SRC N ST WITH SLIDING DOOR AND NATURAL VENTILATION



Description	External dimensions cm (l x w x h)	Door position on wall side	Weight approx. kg	Collection volume L	Galvanised	Galvanised and painted
					Order no.	Order no.
Type SRC 3.1N ST	298.5 x 237 x 241	298.5	700	1000	10365	10366
Type SRC 3.2N ST	473 x 298.5 x 241	298.5	1230	2 x 1000	10367	10368
Type SRC 3.3N ST	707 x 298.5 x 241	298.5	1760	3 x 1000	10369	10370
Type SRC 4.1N ST	402 x 237 x 241	402	880	1000	10371	10372
Type SRC 5.1N ST	505.5 x 237 x 241	505.5	1020	1000	10373	10374
Type SRC 6.1N ST	609 x 237 x 241	609	1350	1000	10538	10539

Further standard sizes on request. | On delivery: Unloading of the goods by the customer

### Please make the most of the opportunity for a consultation:

- container size and media to be stored
- equipment options
- Door layout (long side or short side)
- option of unloading at point of use (as standard, unloading by customer)
- requirements for on-site preparation (e.g. foundation plan)

Please note size-related specifics:  
e.g. centre supports, restrictions to the door position



SRC 3.1 painted with single-leaf door (199.6 cm high, 130 cm wide) on long side, rack and translucent sheet (optional, see accessories)













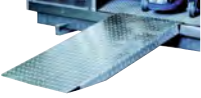







We recommend concluding a maintenance contract for the annual safety inspection together with your purchase. Talk to us!



SRC 4.1, galvanised and painted



## Accessories safety storage containers PG 9

Description	Weight approx. kg	Order no.
 Shelf short, for slotting into place, shelf dimensions 100 x 50 cm, 3 shelves (load 120 kg / shelf)	34	8046
 Shelf long, for slotting into place, shelf dimensions 200 x 50 cm, 3 shelves (load 120 kg / shelf)	63	8047
 Access ramp, (not suitable for models with sliding doors) max. wheel load 450 kg, 70 x 120 cm (w x d)	34	8048
Close-meshed grating		on request
 Double wing door, optional (199.6 cm high, door wing 125 cm wide, side wing 65 cm)		8222
Double wing door insulated, optional (199.6 cm high, door wing 125 cm wide, side wing 65 cm)		8223
 PVC translucent sheet 90 x 200 cm to allow for daylight illumination		10270
  Fan for mechanical ventilation in explosion-proof model (EX)		8224
Exhaust air monitoring for mechanical ventilation		on request
  Finned tubular radiator 910 W with thermostat for safety storage container 1.1 T up to 3.1 T in ex model		8225
  Finned tubular radiator 1680 W with thermostat for safety storage container 3.2 T in ex model		8226
 Convactor heater with temperature controller (non-ex, picture similar)	2 kW	10271
	3 kW	10272
  Linear luminaire 2 x 58 W in ex-proof version incl. switch (non-ex, located on outside of container)		8228
 Linear luminaire 2 x 58 W (non-ex) including switch (non-ex located on outside of container)		90522
  LED diffuser luminaire in ex-proof version incl. switch (non-ex, located on outside of container)		11580
 Fuse box IP 54 (necessary for electrical equipment)		8230
 Set of 4 crane eyelets for up to 1 t total load for safety storage container SRC 1.1, SCR 2.1 and SRC 3.1		10070
 Set of 4 crane eyelets with bars for up to 3 t total load for safety storage container SRC 3.1, SCR 4.1, SRC 5.1 and SRC 6.1		10071

## Secure cabinets FWF 30 and FWF 90 F-SAFE PG 9

Cabinets for proper storage of hazardous substances in work areas in accordance with DIN EN 14470-1 and TRGS 510 (Annex 1).

The F-SAFE secure cabinets are design approved in accordance with DIN EN 14470-1 and comply with DIN EN 14727 (Laboratory Furniture Directive).

The cabinets are resistant to fire for 30 or 90 minutes. The outer body consists of a non-combustible material. The surface coating is highly resistant to chemicals. Body colour light grey, similar to RAL 7035. Door colour zinc yellow, similar to RAL 1023.



Type 12/20  
with recirculation fan



Type 12/20 with 3 spill trays  
and 1 x 44 L bottom tray



Can be accessed by forklift  
for better positioning in the building

### COLLECTION VOLUMES

While the collection volume of 10% of the total amount of stored liquids must be ensured when using collection trays, a different regulation applies in the case of secure cabinets: it must be possible to collect at least 110% of the largest container.

### VENTILATION

A technical ventilation system (see page 192) with 10 air changes per hour has the advantage that, in normal operation with closed containers, no explosive atmosphere can occur outside the cabinet.

Operation is also possible without technical ventilation. For this, however, the cabinet must be earthed via equipotential bonding to prevent electrostatic charging. If a secure cabinet is not connected to a technical ventilation system, this may also affect the explosion-proof zone. Zone 1 applies to the inside area, Zone 2 applies to the surrounding area within a radius of 2.5 m.

**We generally recommend using technical ventilation  
(page 192-193)**

### SECURE CABINETS FWF 30

Secure cabinets with 90-minute fire resistance are considered to be "state of the art" in Germany. However, secure cabinets with 30-minute fire resistance may also be used with restrictions, pursuant to TRGS 510 (Annex 3).

The restrictions for FWF 30 cabinets are as follows:

1. only one cabinet is installed per separate building unit/fire (-fighting) compartment; if the area of the separate building unit/fire (-fighting) compartment is greater than 100 m<sup>2</sup>, one cabinet may be installed every 100 m<sup>2</sup>, or

2. the building unit/fire (-fighting) compartment is protected by an automatic fire detection system and recognised plant fire brigade with a response time of at most 5 minutes from the alarm being raised, or an automatic extinguishing system is in place.

### EXCEPTIONS IN THE CASE OF EXTREMELY FLAMMABLE LIQUIDS (H224):

Flammable liquids whose ignition temperature is below 200°C and which have been classified as „extremely flammable“ (H224) may only be stored in FWF 90 secure cabinets with technical ventilation.

## Secure cabinets FWF 30 PG 9

### Version secure cabinet FWF 30:

- with sign GS and CE
- 30 minute fire-resistance
- single-layer doors and walls in homogenous full material
- in case of fire, self-closing vents on the top of the cabinet, DN 100 mm
- hydraulic door closer with integrated arrest system (thermally triggered) earthing to avoid the danger of ignition due to electrostatic discharge

- height-adjustable feet, can be aligned from inside
- with removable base trim so it can be driven under
- 3 height-adjustable, steel plate spill trays, powder-finished in RAL 7035, load bearing capacity 75 kg (grid size 32 mm)
- one steel plate bottom tray, powder-finished in RAL 7035 with a perforated plate insert



- fully-extending drawers for the storage of small containers, load bearing capacity 65 kg, or 11 kg for 28 litre
- 6/20 with bottom tray 19 litre, 12/20 with bottom tray 44 litre

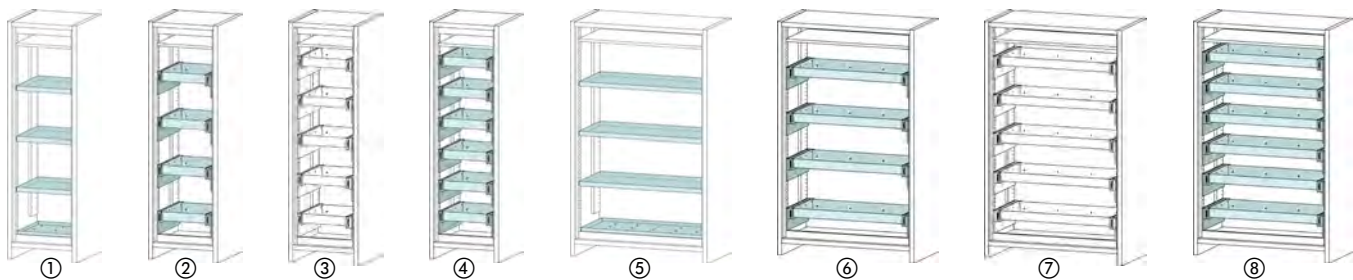

Description / Type	External dimensions cm (l x d x h)	Internal dimensions cm (l x d x h)	Weight approx. kg	Order no.
① 6/20 – FWF 30 3 spill trays, 1 bottom tray	59.5 x 59.5 x 196	47.5 x 51.5 x 160	147	8057
② 6/20 – FWF 30 4 full drawers	59.5 x 59.5 x 196	47.5 x 51.5 x 160	206	10622
③ 6/20 – FWF 30 5 full drawers	59.5 x 59.5 x 196	47.5 x 51.5 x 160	220	10623
④ 6/20 – FWF 30 6 full drawers	59.5 x 59.5 x 196	47.5 x 51.5 x 160	235	10624
⑤ 12/20 – FWF 30 3 spill trays, 1 bottom tray	119.5 x 59.5 x 196	107.5 x 51.5 x 160	226	8055
⑥ 12/20 – FWF 30 4 full drawers	119.5 x 59.5 x 196	107.5 x 51.5 x 160	291	10625
⑦ 12/20 – FWF 30 5 full drawers	119.5 x 59.5 x 196	107.5 x 51.5 x 160	308	10626
⑧ 12/20 – FWF 30 6 full drawers	119.5 x 59.5 x 196	107.5 x 51.5 x 160	324	10627

### ACCESSORIES FOR SECURE CABINETS FWF 30

Description	Order no.
Spill trays for secure cabinets 6/20 FWF 30 F-SAFE	11715
Spill trays for secure cabinets 12/20 FWF 30 F-SAFE	11716

## Secure cabinets FWF 90 F-SAFE PG 9

### Secure cabinet FWF 90 under-table model:

- GS and CE conformity marks
- 90-minute fire resistance (EN 14470-1)
- single-layer doors and walls in homogeneous full material
- self-closing doors in case of fire
- vents on top of the cabinet, DN 100 mm
- adjustable metal feet on the underside of the cabinet
- earthing to prevent electrostatic charging

### Version with hinged doors

- for storage of small containers
- 24 L collection volume

### Version with fully-extending drawer

- smooth-running, fully-extending drawers for the storage of small containers, load bearing capacity 65 kg
- under-table cabinet with 49 L drawer with locking function
- rollers for easy movement
- locking status display
- includes certified pipe feed-through and earth terminal



Version with hinged doors



Version with fully-extending drawer (Figure shows usage example)

Description / Type	External dimensions cm (l x d x h)	Internal dimensions cm (l x d x h)	Weight approx. kg	Order no.
11/6-FWF with hinged doors	110 x 50 x 67	101.5 x 35 x 53	185	8060
11/6-FWF with drawer	110 x 57 x 63	87 x 43 x 46.4	235	11024



# Secure cabinets FWF 90 F-SAFE PG 9

## Version secure cabinet FWF 90 F-SAFE:

- GS and CE conformity marks
- 90 minute fire-resistance
- single-layer doors and walls in homogeneous full material, sandwich rear wall with ventilation
- in case of fire, self-closing vents on the top of the cabinet, DN 100 mm
- single-leaf cabinet with hydraulic door closer with integrated arrest system (thermally triggered)
- double-leaf cabinets with free-running doors, intumescent seal in case of fire
- earthing to prevent the danger of ignition due to electrostatic charging

- height-adjustable feet, can be aligned from inside
- with removable base trim so it can be moved by forklift

## Version with spill trays

- 3 height-adjustable, steel plate spill trays, powder-finished in RAL 7035, load bearing capacity 75 kg (grid size 32 mm)
- one steel plate bottom tray, powder-finished in RAL 7035 with a perforated plate insert
- on request: additional sizes for drum cabinets



## Version with fully-extending drawers

- fully-extending drawers for the storage of small cVontainers (load bearing capacity 65 kg)

We recommend using technical ventilation (page 192-193)



Type 6/20

Type 6/20 with 3 spill trays and 1 bottom tray 20 L

Type 6/20 with 4 full drawers (à 11 litres)

Type 12/20 with 3 spill trays and 1 bottom tray 44 L

Type 12/20 with 4 full drawers (à 28 litres)

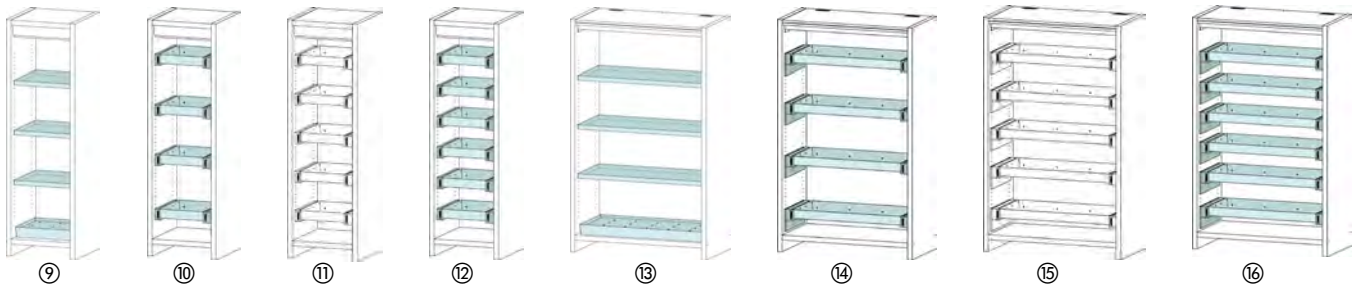

Description / Type	External dimensions cm (l x d x h)	Internal dimensions cm (l x d x h)	Weight approx. kg	Order no.
⑨ 6/20 – FWF 90 3 spill trays, 1 bottom tray	60 x 59.5 x 196	51.6 x 48.3 x 160.3	340	8701
⑩ 6/20 – FWF 90 4 full drawers	60 x 59.5 x 196	51.6 x 48.3 x 160.3	394	10628
⑪ 6/20 – FWF 90 5 full drawers	60 x 59.5 x 196	51.6 x 48.3 x 160.3	408	10629
⑫ 6/20 – FWF 90 6 full drawers	60 x 59.5 x 196	51.6 x 48.3 x 160.3	422	10630
⑬ 12/20 – FWF 90 3 spill trays, 1 bottom tray	120 x 59.5 x 196	111.6 x 48.3 x 160.3	600	8700
⑭ 12/20 – FWF 90 4 full drawers	120 x 59.5 x 196	111.6 x 48.3 x 160.3	673	10631
⑮ 12/20 – FWF 90 5 full drawers	120 x 59.5 x 196	111.6 x 48.3 x 160.3	691	10632
⑯ 12/20 – FWF 90 6 full drawers	120 x 59.5 x 196	111.6 x 48.3 x 160.3	710	10633

## ACCESSORIES FOR SECURE CABINETS FWF 90 F-SAFE

Description	Order no.
① Cable feed-through Ø 30 mm for secure cabinets FWF 90 F-SAFE	10848
② Cable and pipe feed-through Ø 125 mm for secure cabinets FWF 90 F-SAFE	10962
Spill trays for secure cabinets 6/20 FWF 90 F-SAFE	11717
Spill trays for secure cabinets 12/20 FWF 90 F-SAFE	11718



## Ventilation systems PG 9

### FOR SECURE CABINETS FWF 30 AND FWF 90

Escaping vapours and hazardous gas-air mixtures are always possible when flammable liquids are stored in secure cabinets. These Ex-zones form not only inside a secure cabinet, but can also arise within a radius of several metres around it.

The ventilation systems on pages 192 and 193 can be used for our environmental cabinets as well.

Suitable ventilation systems can remove escaping vapours and gases directly where they are produced, effectively preventing an explosive atmosphere forming. Subdivision into Ex-zones is no longer necessary.

Note from TRGS 510, Appendix 1:  
Not only fire resistance class FWF 90 but also technical ventilation systems are required for extremely flammable liquids (H224).

There are two different ventilation systems:

- exhaust air fans, which discharge the extracted air to the outside through an exhaust line
- recirculation fans, which pass the extracted air through integrated filters and thereby render it harmless with regard to explosion hazard before discharging it into the environment



### EXHAUST AIR FAN WITH AIRFLOW MONITORING

For placement on the secure cabinet and discharge of the extracted air into an external exhaust line

- sheet steel housing, powder-coated, light grey RAL7035
- floating output via DIN socket
- intake fitting diameter 75 mm
- output volume: 50 - 200 m<sup>3</sup>/h with volume flow monitoring
- sound pressure level Lp2A: 35 dB(A)
- voltage: 230 V
- frequency: 50 Hz
- power consumption: max. 0.45 A



Solutions ready to plug in

**ATEX-compliant:**  
for extraction from Ex-zone 2  
and installation in Ex-free zone  
protection class: CE  II \_/3 G IIB T4

Description	External dimensions cm (l x w x h)	Weight approx. kg	Order no.
Exhaust air fan SST AL with adapter SST-P for FWF90	42.5 x 25 x 25.5	8	8739

### RECIRCULATION FAN WITH ACTIVE CARBON FILTER

Plug&play recirculation fan with active carbon filter for discharging the exhaust air directly to outdoors.

- sheet steel housing, powder-coated, light grey RAL7035
- incl. active carbon, coarse and fine filters
- saturation level monitoring for filters
- floating output via DIN socket
- intake fitting diameter 75 mm
- output volume: 25m<sup>3</sup>/h with volume flow monitoring
- sound pressure level: 38 dB(A)
- voltage: 230 V
- frequency: 50 Hz



**Advantages:**

- no exhaust pipe to outside required
- no wall opening required

Solutions ready to plug in

**ATEX-compliant:**  
for extraction from Ex-zone 2  
and installation in Ex-free zone  
protection class: CE  II \_/3 G IIB T4

Description	External dimensions cm (l x w x h)	Weight approx. kg	Order no.
Recirculation fan SST UL with adapter SST-P for type FWF90	50 x 28.5 x 29.5	20	10963
Replacement filter set for recirculation fan SST UL	-	-	10964

## Ventilation systems PG 9

### FOR SECURE CABINETS FWF 30 AND FWF 90

#### RADIAL FAN 230 V [model 1](#) made of flame retardant PPS

- with mounting bracket
- intake fitting diameter: 75 mm
- voltage: 230 V
- frequency: 50 Hz
- nominal current: 0.95 A
- output volume: 250 m<sup>3</sup>/h
- operating speed: 2850 rpm
- sound pressure level: 45 dB(A)





**ATEX-compliant:**  
for extraction from Ex-zone 2  
and installation in Ex-free zone  
protection class:  
CE  II 2G Ex h IIB T3 Gc

Description	External dimensions cm (l x w x h)	Weight approx. kg	Order no.
Radial fan 230 V (model 1)	24.6 x 21.6 x 30	4	11431

#### RADIAL FAN 230 V [model 2](#) made of flame retardant PPS-el

- with mounting bracket
- intake fitting diameter: 75 mm
- voltage: 230 V
- frequency: 50 Hz
- nominal current: 1.07 A
- output volume: 150 m<sup>3</sup>/h
- operating speed: 2800 rpm
- sound pressure level: 55 dB(A)





**ATEX-compliant:**  
for extraction from zone 1 and installation  
in zone 1  
Motor:  II 2G Ex eb IIC T4 Gb  
Fan:  II 2G Ex h IIB T4 Gb

Description	External dimensions cm (l x w x h)	Weight approx. kg	Order no.
Radial fan 230 V (model 2)	39 x 22 x 40.8	6	11432

#### RADIAL FAN 380 V [model 3](#) made of flame retardant PPS-el

- with mounting bracket
- intake fitting diameter: 75 mm
- voltage: 3~ 230/400 V
- frequency: 50 Hz
- nominal current: 0,62 A
- output volume 150 m<sup>3</sup>/h
- operating speed: 2825 rpm
- sound pressure level: 55 dB(A)



**ATEX-compliant:**  
for extraction from zone 1 and installation  
in zone 1  
Motor:  II 2G Ex eb IIC T4 Gb  
Fan:  II 2G Ex h IIB T4 Gb

Description	External dimensions cm (l x w x h)	Weight approx. kg	Order no.
Radial fan 380 V (model 3)	37.7 x 22 x 38	6	11433

### ACCESSORIES FOR RADIAL FANS

Description	Order no.
Throttle valve, DN 75 mm, PPS	11434
Intake fitting, ND 120-75 mm, incl. clamp	11435
Sleeve extension, DN 75 mm	11436
Fitting extension, DN 75 mm	11437
Ventilation hose L=750 mm, DN 75 mm, incl. two clamps	11438
Ventilation hose L=2,000 mm, DN 75 mm, incl. two clamps	11439
T-piece, DN 75 mm	11440



# Storage and charging of lithium batteries

The importance of lithium batteries is increasing constantly in our everyday lives. These powerful batteries are increasingly being used not only in small mobile devices or in bicycles (e-bikes) but, correspondingly sized, also in industrial appliances, vehicles and machines. Lithium batteries are powerful, but not without their hazards.

Lithium batteries have long been classified as hazardous goods under transport law and are therefore subject to meticulous hazardous materials regulations which become stricter every 2 years.

Lithium batteries require the utmost care during transport and particularly during storage and handling. If damaged or if handled incorrectly, these batteries can quickly lead to dramatic consequences, usually in the form of a fire. One reason why storing lithium batteries poses a fire safety challenge is that they are not under constant observation, and a fire can spread quickly and unnoticed.

**The typical incidence of damage involves the battery igniting and explosively emitting jets of flame and toxic smoke.**

Summary of the possible causes of fire:

- mechanical damage (e.g. impact, fall)
- improper charging process
- deep discharging
- overheating due to high ambient temperature

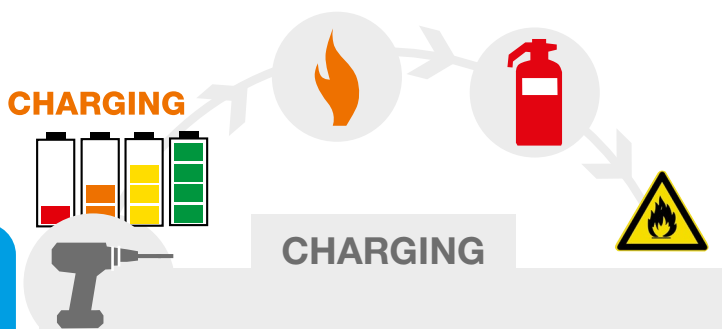

**Most of the lithium battery-related fires studied in Germany occurred during the charging process.** Safety specialists, fire brigades and property insurers are therefore paying closer attention to this threat.

Unfortunately, practical experience has shown us that there are many (deliberately or unintentionally) incorrect ways to charge batteries. Even a lithium battery which looks perfectly intact from the outside can already be damaged enough on the inside that adding electrical energy via the charger can cause a fire hazard. Charging stresses a lithium battery. Frequent charging, hard use and wear place a burden the battery to the point that any charging process could be the last one.

Charged lithium batteries pose a higher fire hazard (cause) and burn more intensely (effect). Therefore, the charging process must never be underestimated and must always take place under supervision at a designated location. Charging in the workplace therefore requires a risk assessment which takes into account the risk to employees and the environment, as well as the building layout. These findings should be included in the fire prevention plan.

Overheating due to causes such as direct sunlight or heat build-up during charging must also be avoided.

**Important:** Lithium batteries are mentioned in German Regulation TRGS 510. Due to their higher hazard level, appropriate fire protection measures must be taken.

## STORAGE

So far, there are no statutory regulations for the storage and supply of lithium batteries. Occupational safety obligations and, above all, insurance guidelines nevertheless mean that the information to be observed regarding the storage and operation of lithium batteries is just as comprehensive as that applicable to traditional hazardous materials storage.

VdS Guideline 3103 from the German Insurance Association (GDV) is a current source of important information about storing and supplying lithium batteries.

Storage also involves the danger of a nearby fire spreading to the lithium batteries. A small, extinguishable fire source can then become a major challenge to the fire brigade.

A risk assessment in combination with the right charging and storage solution effectively improves safety in the workplace. Not all lithium batteries are the same. Therefore, there is no "one size fits all" protection scheme. In addition, the information provided by the manufacturers of energy storage devices and battery-operated devices must be observed at all times. Suitable technical protective measures, such as tested transport containers, safety cabinets or even fire protection containers, always depend on the circumstances in the workplace.

## CHARGING + STORAGE

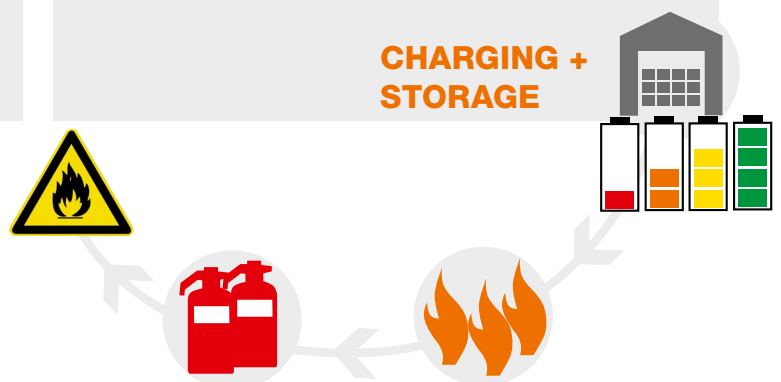

**Practical tip**  
CHARGE AND STORE LITHIUM BATTERIES SEPARATELY!

# Storage and charging of lithium batteries

## CEMO SAFETY NOTE

### Safety rules for CHARGING

- Never charge in the storage area.
  - Maintain a clearance of several metres from combustible objects.
  - Never charge damaged or faulty batteries.
  - Avoid heat build-up during charging.
  - Use only the original charger.
  - Immediately disconnect the battery from the mains after charging.
  - Avoid charging overnight.
- Unsupervised charging poses a higher risk.

**Fire extinguishing is still the most disputed topic regarding lithium batteries.** Although small quantities of water can worsen the reactions of lithium-ion batteries, large quantities have a cooling effect and, in the ideal case, can interrupt the thermal runaway process.

The fire brigade also fight fires with plenty of water, which at least prevents the flames spreading to the surroundings. It is therefore crucial to alert the fire brigade as soon as possible so they can extinguish the fire.

### Safety rules for STORAGE

- Protect against short circuit of the battery poles.
- Protect against mechanical damage.
- Separate storage, i.e. no mixed storage.
- When storing batteries inside buildings, maintain a distance of 2.5 m from other installations or store them in areas that are isolated in terms of fire prevention (e. g. fire protection containers, safety cabinets).
- Immediately dispose of damaged products properly, even in case of slight abnormalities.
- Do not expose directly and permanently to high temperatures.
- Train employees how to handle lithium batteries properly.
- Provide suitable fire extinguishers.

Damaged/defective batteries, prototypes or batteries for disposal require a hazard assessment and possibly additional protective measures.

## Additional storage solutions for lithium batteries

### STEEL CONSTRUCTION

**F90 F-SAFE fire protection container**  
with DIBt certification



**F90 F-SAFE fire protection container**  
with DIBt certification



Additionally available as a self container.



### CONCRETE CONSTRUCTION

**F90 F-SAFE fire protection storage cell**



**F90 F-SAFE fire protection storage**  
walk-in version



Ask about our guide to storing lithium batteries.

# How to find the right product for your application:



## CEMO safety matrix Storage of Li batteries

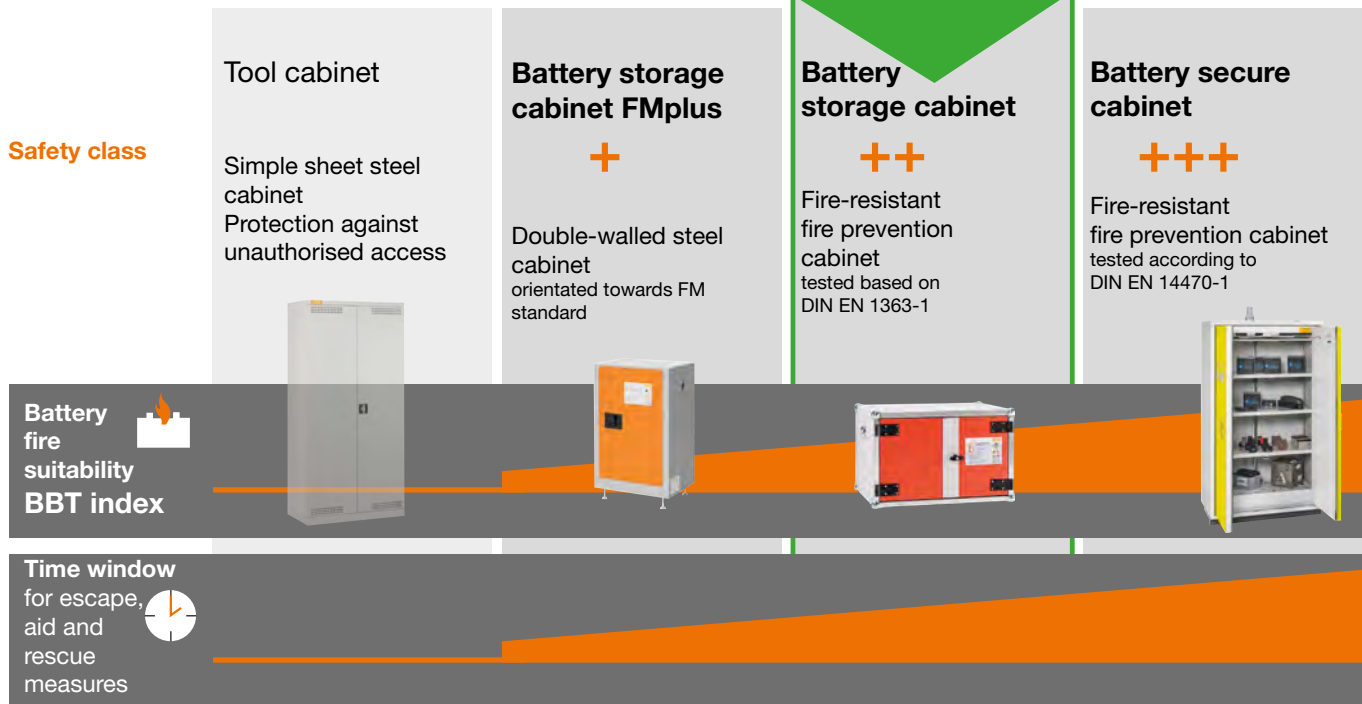

### Orientation for use depending on result of the risk assessment \*

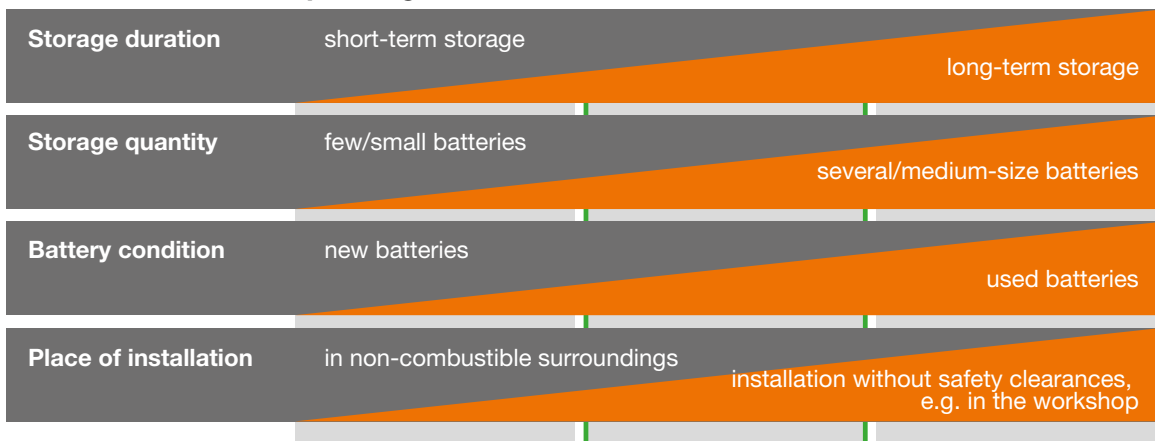

\* Risk assessment depends on additional factors, such as specifications of the property insurer, sprinkler system or works fire brigade

Risk increase of the situation

### CEMO BBT index

CEMO was the first company to introduce the term “battery fire suitability (BBT)”. The BBT is checked in real-world battery fire tests, which involve testing the pressure shock, battery fire, gas generation and thermal insulation. Information gained from these tests was used to develop reference safety classes for storage and charging.



# Battery storage cabinet FMplus

Leaving even a single lithium battery from a battery-powered device lying around in the open could be enough to ignite a fire. This is where the new CEMO FMplus battery storage cabinet as the economical entry-level solution can help.

Based on the risk assessment, this double-walled steel cabinet can be used as a protective measure for new lithium batteries from devices such as power tools or garden equipment.

The cabinet is available in three sizes:

- sturdy, heat-insulating double-walled steel cabinet
- lockable door with three-point lock
- can be locked with a padlock if necessary (profile half cylinder lockable)
- additional door seals keep cold smoke in the housing
- vent for proper connection to the exhaust pipe to the outdoors
- forklift access clearance (8-9 cm) for positioning and removal in the event of an incident
- equipped with smoke detector for audible alarms as standard
- powder coating body light gray (RAL 7035) and door light red orange (RAL 2008)
- includes warning labels and safety instructions

For storing low-power lithium batteries (see VdS 3103)

A battery fire test was performed on power tool batteries.

**Safe and cost-effective storage: FMplus, the entry-level model.**

Perfect protection – with safe storage systems  
CEMO expert tip:  
Store and charge separately.  
This minimizes the fire load.



Accessories: Set of castors

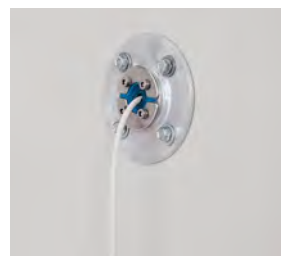

Accessories: Cable duct



Accessories: Adapter for ventilation line

Description	Shelves	External dimensions in cm (w x d x h)	Internal dimensions in cm (w x d x h)	Weight (approx.) in kg	Order no.
Battery storage cabinet <b>FMplus US</b>	2	43 x 43 x 56	35 x 35 x 46	27	11651
Battery storage cabinet <b>FMplus S</b>	3	59 x 46 x 89	51 x 38 x 79	47	11652
Battery storage cabinet <b>FMplus L</b>	4	60 x 46 x 165	52 x 38 x 154	83	11653

## ACCESSORIES FOR BATTERY STORAGE CABINET FMplus

Description	Order no.
Insert shelf for FMplus S battery storage cabinet	11655
Insert shelf for FMplus L battery storage cabinet	11656
Set of castors for FMplus battery storage cabinet	11657
Second smoke detector (can be networked with internal smoke detector)	11658
Padlock with profile half-cylinder NP 30x12 mm	11659
Cable duct for FMplus battery storage cabinet (e.g. for installation of in-house fire alarms)	11660
Adapter for ventilation line for FMplus battery storage cabinet	11661

# Battery storage and charging cabinet PG 9

Fire prevention is important when charging lithium batteries. CEMO now offers a safe solution. Providing important safety equipment can minimise the consequences of these storage devices burning and significantly increase safety.

- storage and/or charging of several lithium batteries in the cabinet
- early alarm in case of damage
- all relevant safety regulations for charging lithium batteries are observed
- ideal for separating batteries on charge from stored units
- can also be used as an under-table cabinet under the workbench

**Properties:**

- MPA-tested fire resistance over 60 minutes from inside to outside according to DIN EN 1363-1
- Real battery fire test carried out by an independent university
- built using non-combustible, fire-resistant components
- special fire prevention seals prevent flames escaping
- cold smoke-tight sealing system for openings
- transportable for positioning at the place of installation
- lockable double doors with sturdy lock and hinges
- doors painted orange, matching to RAL 2004; body grey, matching to RAL 7035



Example



Video battery charging cabinet

**NEW**



**Battery storage cabinet 8/10**  
with 1 shelf as standard at half height. Optionally 2 more shelves possible (see accessories).



Insight into the development work: A real battery fire test with e-bike batteries was successful.



**Battery storage cabinet 8/5**

## BATTERY STORAGE CABINETS

Description		External dimensions cm (l x w x h)	Internal dimensions cm (l x w x h)	Weight approx. kg	Order no.
<b>Battery storage cabinet 8/5</b>	Two battery-operated audible smoke detectors - without power connection, without fan - additionally with stacking feet (required when stacking the cabinets 8/5)	80 x 66 x 52	73 x 53 x 45	105	11341
		80 x 66 x 62	73 x 53 x 45	108	11576
<b>Battery storage cabinet 8/10</b>	Two battery-operated audible smoke detectors - without power connection, without fan - with feet <b>NEW</b>	80 x 66 x 111	73 x 53 x 91	132	11692

# Battery storage and charging cabinet PG 9



Battery charging cabinet 8/5 Basic

**For all charging versions:**

- heat dissipation by fan during charging
- charging current is interrupted if the doors are opened
- charging stops if a malfunction or accident occurs
- vents sealed with thermocouples

**Battery charging cabinet 8/5**

- power supplied by a four-socket power strip (3500 W, 16 A)

**Battery charging cabinet 8/10**

- Charging versions with 2 vertically arranged 4-way socket strips for power supply
- 230 V version with 1-phase power supply (3500 W / 16 A)
- 400 V version with 3-phase power supply (2 x 3500 W / 2 x 16 A)

**Tip:** The 3-phase version is necessary if, for example, batteries are to be charged with fast chargers that have a greater current requirement than the 1-phase version can provide.

**NEW**



Battery charging cabinet 8/10 Premium Plus 3-phase

**New:** All versions with audible alarm

Premium and Premium Plus:

Now with improved connection option for combination alarm transmitter (12V) and connection to fire alarm system.

## BATTERY CHARGING CABINETS

Description		Version	External dimensions cm (l x w x h)	Internal dimensions cm (l x w x h)	Weight approx. kg	Order no.
<b>Battery charging cabinet Basic</b>	Two battery-operated audible smoke detectors, power supply in cabinet, technical ventilation, power disconnection in case of heat development, door contact switch	8/5 1-phase	80 x 66 x 52	73 x 53 x 45	106	11342
		8/5 with stacking feet*, 1-phase	80 x 66 x 62	73 x 53 x 45	109	11577
		8/10 with stacking feet, 1-phase <b>NEW</b>	80 x 66 x 111	73 x 53 x 84	135	11693
		8/10 with stacking feet, 3-phase <b>NEW</b>	80 x 66 x 111	73 x 53 x 84	136	11696
<b>Battery charging cabinet Premium</b>	Modification to charging Basic: electronic smoke detector (without audible alarm) In addition to charging Basic: power disconnection in case of smoke detection and voltage-free output on the outside of the cabinet for connection to a fire alarm system, 12 V connection for e.g. accessory combination alarm unit (visual and audible)	8/5 1-phase	89 x 66 x 52	73 x 53 x 45	106	11343
		8/5 with stacking feet*, 1-phase	89 x 66 x 62	73 x 53 x 45	109	11578
		8/10 with stacking feet, 1-phase <b>NEW</b>	89 x 66 x 111	73 x 53 x 88	135	11694
		8/10 with stacking feet, 3-phase <b>NEW</b>	95 x 66 x 111	73 x 53 x 88	136	11697
<b>Battery charging cabinet Premium Plus</b>	In addition to charging Premium: internal temperature display, with remote alarm and data transmission via SIM card; additional functions via remote access	8/5 1-phase	89 x 66 x 52	73 x 53 x 45	106	11344
		8/5 with stacking feet*, 1-phase	89 x 66 x 62	73 x 53 x 45	109	11579
		8/10 with stacking feet, 1-phase <b>NEW</b>	89 x 66 x 111	73 x 53 x 88	135	11695
		8/10 with stacking feet, 3-phases <b>NEW</b>	95 x 66 x 111	73 x 53 x 88	136	11698

\* stacking feet (required when stacking the cabinets 8/5)



# Battery storage and charging cabinet PG 9



Forkliftable for simple positioning and rapid removal to the outdoors in the event of a fire



① Extremely flexible, eg. for cabling of the in-house fire alarm system

② Stacking feet, set

③ Combination alarm unit (strobe light)  
Visual and audible alarms if an accident occurs, enabling additional protective measures to be taken promptly

④ Set of two network-capable smoke alarms (audible). Included in "Storage" and "charging Basic" as standard

⑤ Effective aerosol extinguishing agent for lithium batteries, for initial, rapid extinguishing and flame suppression, automatic pyrotechnical triggering, maintenance free

⑥ Ideal for making the best possible use of available space and enlarging the storage area for small-cell lithium batteries (bear in mind the total capacity of the lithium batteries in the event of a fire)



⑦ Simple relocation in the building and removal in the event of an accident; two of the four steering castors are fitted with an integral foot brake

⑧ Shelves can be adjusted to the ideal working height; cabinets can be loaded using a high-platform truck or forklift; including wall mounting materials

## ACCESSORIES FOR BATTERY STORAGE AND CHARGING CABINETS

Description	Dimensions cm (l x w x h)	Weight approx. kg	Order no.
① Fireproof cable entry	14 x 2.5 x 14	1.3	11345
② Stacking feet, set (stacking only for cabinet size 8/5)	10 x 6 x 10	3	11368
③ Combination alarm unit, visual and audible alarm (100 dB) (only for charging Premium and charging Premium Plus)	7.3 x 4.3 x 12.2	-	11389
④ Wireless heat and smoke alarms, set of two, battery operated, network capable, incl. two magnetic plates	ø 12.5 x 4.8	-	11560
⑤ Aerosol extinguisher (0.25 m <sup>3</sup> extinguishing capacity)	ø 6.5 x 3.8	-	11561
⑥ Insert shelf (for floor level or as intermediate level)*	67 x 40 x 3.5	-	11508
⑦ Trolley, 240 kg load capacity, for up to two cabinets 8/5 or one 8/10	80 x 60 x 15	11.3	11461
⑧ Rack, for up to two cabinets, including wall mounting (only in combination with stacking feet)	106 x 53.5 x 200	50	11562
Circuit breaker box for 1-phase cabinet 8/10 (delivered fully assembled)	Recommended for socket on the building side without own circuit breaker	NEW	11713
Circuit breaker box for 3-phase cabinet 8/10 (delivered fully assembled)		NEW	11714

\* Separator for insert shelf available on request.

## Battery secure cabinet FWF90 PG 9

### FOR THE STORAGE OF LITHIUM BATTERIES

These fireproof secure cabinets are well suited to storing lithium batteries. The proven quality is reflected in the 90-minute fire resistance pursuant to DIN EN 14470-1 on both the outside and the inside. In addition, the cabinet's unique design using non-combustible materials provides good fire prevention from both the inside and the outside, even in the event that the stored lithium batteries suddenly ignite. This period is normally sufficient until further action can be taken. The risk of the fire spreading and accelerating is significantly reduced with this cabinet and consequential damage to the environment is effectively reduced in the event of flame formation caused by the lithium batteries inside the cabinet.



Cable duct:  
accessory see page 191



Battery secure cabinet 12/20

These secure cabinets achieve a high level of safety, thereby providing strong support when conducting risk analyses for on-site storage. The safety cabinets are based on the current guidelines issued by the German Insurance Association (GDV) for the storage of undamaged lithium batteries (leaflet „VdS 3103“). We therefore recommend that you consult your property insurance company.

Note: With grey doors (similar to RAL 7035) as standard; zinc yellow (similar to RAL 1018) also available on request.

Description	External dimensions cm (l x d x h)	Internal dimensions cm (l x d x h)	Shelves	Weight approx. kg	Order no.
Battery secure cabinet 11/6	110 x 57 x 63	87 x 43 x 46.6	1 drawer	235	11051
Battery secure cabinet 6/20	60 x 59.5 x 196	51.6 x 48.3 x 160.3	4 shelves	340	11052
Battery secure cabinet 12/20	120 x 59.5 x 196	111.6 x 48.3 x 160.3	4 shelves	600	11053

## Battery secure cabinet PRO FWF 90 PG 9

### FOR STORAGE OF LITHIUM BATTERIES

This EN 14470-1-compliant secure cabinet has sophisticated protective mechanisms that provide excellent protection against fires within the cabinet caused by lithium batteries. As soon as a fire breaks out on one of the shelves, the doors close. Then, the special locking technology that has been installed is deployed, ensuring that the doors remain closed even when the escaping gases ignite. In this case, the system also ensures that the doors can only be opened again by authorised experts. In addition, the cabinet can also be adapted to various requirements.

Talk to us, we'd be pleased to assist.



Talk to us about compartment subdivision, cable ducts, power supply, sensor-controlled temperature monitoring and other additional sizes.

Description	External dimensions cm (l x d x h)	Internal dimensions cm (l x d x h)	Shelves	Weight approx. kg	Order no.
Battery secure cabinet Pro	119.5 x 59.5 x 208	110 x 44.5 x 183	4	469	11214

# Transport of lithium batteries

Lithium batteries are classified as hazardous goods under transport law. UN certification of the container is not sufficient to ensure that all requirements for ADR-compliant transport of lithium batteries are satisfied in all cases.

We therefore advise our customers to familiarise themselves with this topic and to provide comprehensive training for their employees on how to use the containers in compliance with regulations.

This includes knowledge about the official packaging instructions (see table), marking as per ADR and implementing transport. It also covers conscientious handling of damaged lithium batteries, for example.

If transport containers are properly packed according to the hazardous materials regulations, they can often also be used for storage purposes at the company. It is nevertheless advisable to conduct a hazard assessment in line with the situation on site, additionally involving the plant safety officer and possibly the property insurer as well.



## SPECIAL REGULATIONS AND PACKAGING INSTRUCTIONS

	Special regulations according to ADR	Packaging instructions according to ADR
Small, intact lithium batteries <100 Wh	SV188	-
Intact lithium batteries >100 Wh	SV230	P903
Prototypes	SV310	P910
Batteries for disposal/recycling	SV377	P909
Damaged/defective batteries	SV376	P908
Critically damaged/defective batteries (not safe to transport)	SV376	P911

	Certification of the packaging		Packaging instructions according to ADR				
	Packaging group	UN coding	Intact lithium batteries >100 Wh (usual case)	Proto- types	Batteries for disposal/recycling	Damaged/de- fective batteries	Critically dam- aged/defective batteries (not safe to transport)
			P903	P910	P909	P908	P911
Plastic collection container S	VG2	Y	✓	✓*	✓	✓*	✗
Plastic collection container L	VG2	Y	✓	✓*	✓	✓*	✗
Steel collection container for batteries	VG1	X	✓	✓	✓	✓	✗
Safety drum for batteries	VG1	X	✓	✗	✓	✓	✗
Safety container for batteries	VG2	Y	✓	✓	✓	✓	✗

Please always pay attention to compliant packaging and transport as well

\* possible in principle but not recommended



# Battery system fire protection box Li-SAFE PG 9



- safe transport and storage system for lithium batteries
- special fire prevention lining made of non-combustible materials
- formable special pads prevent the batteries shifting inside the box (included)

- boxes are stackable and can be inter-connected
- two sturdy latches
- two handles for simple handling
- can be locked with a padlock (not included)
- made of durable, impact-resistant plastic
- including hazardous goods labels

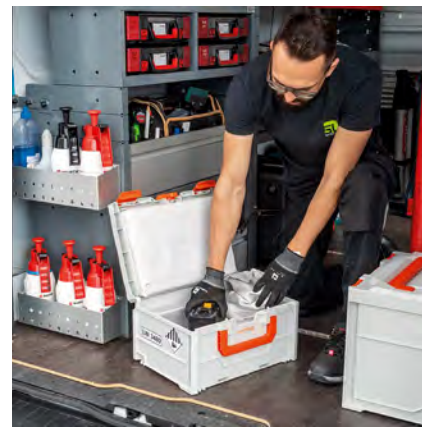

Faulty batteries must be transported safely during work.



### Possible applications:

- UN certification for lithium batteries in packaging group II
- for lithium battery weighing up to 5 kg
- transport possible on public roads in accordance with the regulations
- additionally usable as a stationary safety container for storage
- fire-protected storage for transport and on construction sites, for example
- ideal for safely isolating highly hazardous batteries (e.g. faulty or quarantined batteries)



Essential if battery-powered devices are used in a company, because batteries can fail at any time (fire hazard).



Successful fire test: the CEMO fire prevention box withstands the flames.

Description	External dimensions cm (l x w x h)	Internal dimensions cm (l x w x h)	Quantity of special pads	Weight when empty kg	Order no.
Battery system fire prevention box Li-SAFE 2-S	40 x 30 x 21.5	30 x 19 x 9	2	4.5	11563
Battery system fire prevention box Li-SAFE 3-S	40 x 30 x 34	30 x 19 x 21.5	3	6	11564

### ACCESSORY

Further sizes on request.

Special pads for battery system fire protection box	11565
---	-------

Overview of ADR regulations see page 202.

## Battery safety barrel PG 9

- 60 litre clamping ring lidded drum
- special valve for pressure relief in the event of damage
- UN certification for hazardous goods belonging to packaging groups I, II or III
- for use with vermiculite as a buffer material
- 60 kg permissible total weight
- ideal for use as a storage bin for damaged batteries awaiting disposal

- certified for the transportation of lithium batteries (UN 3480 and UN 3090) weighing 0.5 - 5 kg
- Special ADR regulations apply for transportation (see special regulations and packaging instructions, p. 202).
- Please observe the enclosed packaging instructions!
- incl. 1/2 filled with vermiculite and plastic bag



pressure relief in the event of damage in accordance with the pressure cooker principle



**Ideal for the safe storage of defective batteries for eBikes, power tools, garden tools and much more.**



Description	Dimensions cm (ø x height)	Storage capacity L	Weight when empty kg / maximum weight	Order no.
Battery safety barrel	38 x 66	60	4.9 / 60	11200

### ACCESSORIES

Sack of vermiculite (corresponds to approx. 50 L)	4.5	11205
Lining bag for battery safety barrel		11232
Plastic bag for single battery		11233

## Battery steel collection container PG 9



Battery steel collection container with vermiculite (see accessories)



- 120 litre storage capacity
- ideal for use as a storage container for damaged batteries awaiting disposal
- robust, hot-dip galvanised steel container with sturdy closure buckles
- circumferential rubber seal protects against penetrating moisture
- lid can be opened easily and locked in place in a single step



- can be driven under, stacked and lifted by crane for easy handling
- for use with vermiculite or expanded glass granulate as a buffer material (see page 205)
- UN certification for hazardous solid goods belonging to packaging groups I, II and III
- Special ADR regulations apply for transportation (see special regulations and packaging instructions, p. 202), may only be carried out by qualified personnel.

Description	External dimensions cm (l x w x h)	Internal dimensions cm (l x w x h)	Storage capacity L	Weight when empty kg / maximum weight	Order no.
Battery steel collection container	71.5 x 71.5 x 58	58 x 58 x 39	120	54 / 170	11201

### ACCESSORIES

Sack of expanded glass granulate (corresponds to approx. 55 L)	12,5 kg	11204
Sack of vermiculite (corresponds to approx. 50 L)	4,5 kg	11205
Lining bag for collection container		11231
Plastic bag for single battery		11233

# Plastic collection container PG 9

Optimal storage and transport system

- UN-certified storage and transport system for solid hazardous goods (classified in packaging groups II and III)
- high-density, impact-resistant PE plastic (PE-HD)
- stackable and safe to transport
- ideal for collecting lithium batteries for recycling and disposal

- For reasons of fire prevention, use only in combination with suitable buffer material (e.g. vermiculite or expanded glass granulate).
- Observe packaging instructions (e.g. P909, p. 202) for ADR-compliant transport.
- delivery with lid and ratchet straps



Description	External dimensions cm (l x d x h)	Internal dimensions cm (l x d x h)	Collection volume L	Filling weight approx. kg	Order no.
Plastic collection container S	120 x 80 x 40	111.5 x 71.5 x 24.5	195	300	11202
Plastic collection container L	120 x 100 x 76	112 x 92 x 60	610	400	11203

## ACCESSORIES

Sack of expanded glass granulate (corresponds to approx. 55 L)	12.5	11204
Sack of vermiculite (corresponds to approx. 50 L)	4.5	11205
Lining bag for plastic collection container S		11229
Lining bag for plastic collection container L		11230
Plastic bag for single battery		11233

# Buffer material for storage and transport

## Expanded glass granulate and vermiculite

- not flammable
- high thermal insulation
- highly effective at absorbing escaping electrolyte
- not electrically conductive

Both materials have long been tried and tested buffers in hazardous goods packaging. Used carefully, these granulates can prevent flames from spreading from one cell to another. Expanded glass granulate is particularly suitable for lithium battery applications, because it forms a protective shielding layer around the cells in the event of a fire.



Expanded glass granulate



Vermiculite



Description	Filling weight approx. kg	Order no.
Sack of expanded glass granulate (corresponds to approx. 55 L)	12.5	11204
Sack of vermiculite (corresponds to approx. 50 L)	4.5	11205



## Collection containers for indoor storage PG 9

### Battery disposal box

optimal storage and transport system

- high density PE plastic (HDPE)
- maximum acid resistance
- can be loaded up to 600 kg as individual box, up to 450 kg per box when stacked
- stackable up to 7 boxes
- for transporting old batteries (Rh 2807) in accordance with ADR 4.1.4.1 P801
- stackable and safe for transport
- equipped with three runners
- labelled with hazard warnings



Box 610 L

Not certified for storage and transport of lithium batteries



Box 300 L

Capacity L	External dimension cm (l x w x h)	Weight approx. kg	Order no.
300 with four feet	100 x 63.5 x 64.5	14.3	11450
525 with two runners	120 x 80 x 80	30	11451
610 with three runners	120 x 100 x 76	37	8322

### ACCESSORIES

Capacity L	External dimension cm (l x w x h)	Weight approx. kg	Order no.
Lid for box 300	103 x 65 x 7,5	5	10159
Lid for box 525	121.5 x 81.5 x 6	6	8614
Lid for box 610	121.5 x 101.5 x 6	7	8086

## Fluorescent tube collection box PG 8

### Fluorescent tube collection box

- grey/orange container made of high-quality PE
- for transporting and storing fluorescent tubes up to 155 cm long
- with optional side door
- stackable, with retaining cam

- with forklift pockets
- with integrated handles
- with lid opening restrictor
- with three toggle latches
- completely splash proof thanks to an all-round integrated seal



Description	Capacity L	External dimension cm (l x w x h)	Internal dimension cm (l x w x h)	Weight kg	Order no.
PE collection box 750, grey/orange, with side door	750	170 x 84 x 80	154 x 70 x 63	43	10336
PE collection box 750, grey/orange	750	170 x 84 x 80	156 x 70 x 63	42	10335

See page 248 for more sizes and versions.

## Collection containers for outdoor storage PG 9

### Vehicle battery disposal container

- sturdy GRP model enables clean and safe storage for waste vehicle batteries
- certified for transport in accordance with ADR 4.1.4.1 P801
- two vents and a galvanised steel base frame for stable positioning
- all fittings are stainless steel

- removeable wooden grating forms a level base surface
- lid with hasp catch for padlock
- labelled with hazard warnings

Not certified for storage of lithium batteries



### VEHICLE BATTERY DISPOSAL CONTAINER

Capacity L	External dimension cm (l x w x h)	Weight approx. kg	Order no.
200	89 x 59 x 81	23	3396
400	120 x 80 x 81	37	3397
700	134 x 99 x 110	50	3983

# MOBILE box for hazardous materials, certified PG 9

## Mobile box

The robust design enables clean and safe storage of hazardous solid goods belonging to packing groups II or III and is also certified for transport according to ADR, RID and IMDG codes. The container (grey), with a capacity of 170 L or 250 L, and lid (coloured) are easy to handle, even when the container is full. The specially shaped lid enables storage in 2-layers. Up to 8 boxes can be safely stacked on a Euro pallet. The beading in the container wall enables emptying with a rotary forklift.

The mobile box is particularly suitable for the following applications:

- collection container for waste and materials such as oil binding agents, paint residues, etc.
- collection and transport container for recycling, cleaning cloths, etc.
- collection container for flammable and polluting substances



Up to 8 containers on a Euro pallet, two layer stackable



170 L      250 L



Lid with PU seal, fire-classified, light and air-tight for moisture-sensitive material, red lid version



Orange lid version



Green lid version



Red lid version



Blue lid version

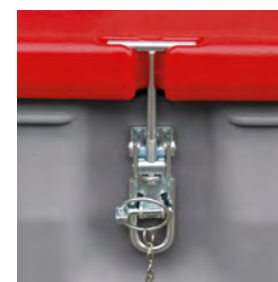

Lockable mechanism with metal bracket and locking spring

Description	Dimensions per packing unit cm (l x w x h)	Weight approx. kg	Order no. /lid			
			orange	red	green	blue
Mobile box 170 L	60 x 40 x 88	12	11453	11454	11455	11456
Mobile box 250 L	60 x 60 x 89	15	11457	11458	11459	11460

## Aerosol spray can collection container PG 9

**Mobile collection container for empty and partially empty aerosol spray cans. Tested safety via UN certification 1H2W/X150/S...**

- certified for UN 1950 (waste aerosol containers)
- integrated opening to dispose of spray cans when the lid is closed
- lid with rubber seal and sturdy latch
- two integral vents for air circulation in the body

- manufactured in anti-static plastic for additional safety, therefore particularly suitable for installation in side buildings
- large wheels and a heat-treated steel axle for easy movement even when filled; maximum weight up to 150 kg
- grey body, orange lid
- delivery includes nonwoven pads (to absorb leaking fluids) and "UN1950" hazardous goods label
- Observe the relevant packaging instructions for transport under ADR.

**Anti-static version:**  
Extra safety for workshop and industrial use



Lid with rubber seal and latch



Volume 120 litres



Sturdy latch



Spray cans can be disposed of without opening the lid



Large wheels and integral vents

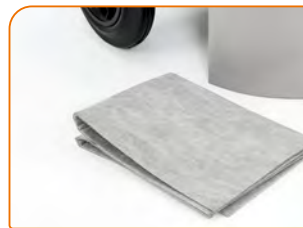

Including nonwoven pads

Never dispose of empty spray cans as general waste or together with other waste.

Description	Dimensions cm (w x h x l)	Volume L	Weight kg	Order no.
Mobile collection container for aerosol spray cans	49.8 x 55.4 x 96	120	11	11346

## Safety disposal container PG 9

**Essential for every safety-conscious workshop and industrial building. Ideal for cleaning cloths saturated with flammable liquids, for example.**

- tightly sealing lid is designed to prevent self-ignition by excluding oxygen
- self-closing due to maximum opening angle of 60°
- ventilation holes and clearance to the ground reduce the risk of overheating

- foot pedal for hygienic hands-free opening
- sturdy design made of painted sheet steel
- wear-free, durable mechanism
- light weight for simple handling and emptying
- suitable plastic bags available separately



Description	Capacity L	Dimensions cm (l x w x h)	Weight approx. kg	Order no.
Safety disposal container	22.5	ø 36.5 x 39.5	5.6	11558

### ACCESSORY

Plastic bags (50 pcs)	11559
-----------------------	-------



## MOBILE oil suction units PG 4

### Pneumatic oil suction unit

Compressed-air operated mobile oil extractor

Ideal for quick oil changes on larger vehicles such as lorries, tractors, and cars, etc. A vacuum is generated in the tank with the aid of compressed air. The oil can then be decentrally extracted from the engines using the extraction probes, independently of a compressed-air connection. Ideal oil temperature 70-80 °C.

Tank is drained by compressed air.



Oil suction unit 90 L with height-adjustable eccentric collection hopper

### Technical data 8726 and 10145:

- mobile 65 L or 90 L container with level indicator, vacuum indicator and 1-bar relief valve
- compressed-air connection ¼"
- removable tool tray
- extraction hose 2 m with probe adapter
- 7 different flexible and rigid probes; direct adapters for Mercedes, VW, BMW and Citroen
- drain hose 2 m
- max. extraction volume 52 L resp. 75 L
- maximum hopper height 188 cm (model 10145)



Oil suction unit 65 L

Pneumatic oil suction unit 80 L



### Technical data 10690 and 10691:

- mobile 80 L container with level indicator, vacuum indicator and relief valve
- compressed-air connection ¼"
- extraction hose 1.5m with probe adapter
- 5 different flexible and rigid probes from 5 mm up to 8 mm
- drain hose



Pneumatic oil suction unit 80 L, with collection hopper

## PNEUMATIC OIL SUCTION UNITS

Description / Capacity L	Dimensions cm (l x w x h)	Weight approx. kg	Order no.
65 L	60 x 42 x 86	26.9	8726
90 L with collection hopper	62 x 42 x 138	38.2	10145
80 L	44 x 49 x 77	24.5	10690
80 L with collection hopper	58 x 49 x 173	27.5	10691

### Electric oil suction unit

The mobile oil suction unit meets the growing requirement for sucking waste oil directly out of a car engine via the oil dipstick seating. An integral 12 L reservoir container can hold the removed waste oil directly. The oil suction unit has a special self-priming centrifugal pump which can produce very high vacuum pressures.

### Technical data

Mobile frame complete with:

- self-priming centrifugal pump, 230 V, delivery rate 2 to 10 L/min

- vacuum gauge for checking the pump's operation and for successful emptying
- suction hose with fast connection for the probes
- 4 different suction probes (semi-rigid probe dia. 6 x 800 mm, semi-rigid probe dia. 8 x 800 mm, rigid probe dia. 8 x 650 mm, rigid probe dia. 9 x 650 mm)
- removable probe holder with liquid-tight base for collection of any oil drops
- removable transparent collection container 12 L
- suitable for oils up to SAE 140



## ELECTRIC OIL SUCTION UNIT

Description	Dimensions cm (l x w x h)	Weight approx. kg	Order no.
12 L	32 x 32 x 90	19.5	8253

## MOBILE extraction unit for fuels PG 4

### Extraction and refuelling trolley for petrol, 2-stroke mixture and diesel

Used in the event of misfuelling, accidents, vehicle returns, etc.

- with flashback arrester in filler neck
- 2 m extraction hose DN 10 and 3.2 m delivery hose
- operated with 12V electric pump
- 4.1 m connection cable and earthing cable with crocodile clips

- automatic dispensing nozzle, hose certified for petrol
- switch between extraction and dispensing via ball valves
- flexible probe dia. 8 mm/1.500 mm
- flexible probe dia. 12 mm/700 mm
- adapter for dia. 6 mm hose
- adapter for dia. 10 mm hose
- holder for probes and adapter (not mounted on trolley)



Description	Dimensions cm (l x w x h)	Weight approx. kg	Order no.
Electric extraction and dispensing trolley 95 L	100 x 56 x 48	23	10762

### KS-Mobil Easy 190 litre extraction unit for fuels

#### 2-stroke mix and diesel, in the event of misfuelling, accident, vehicle return, etc.

- certified for transport under ADR
- for mobile use outdoors and indoors
- with explosion-suppressing insert
- with forklift pockets
- operated with 12V pump
- 4 m connecting cable with crocodile clips
- with digital flow meter
- with earthing cable 2 m
- with hose DN 16, 3 m, electrically conductive, for extraction
- with hose DN 19, 4 m, electrically conductive, for dispensing
- automatic dispensing nozzle, hose certified for petrol

- switch between extraction and dispensing via ball valves
- flexible probe Ø 8 mm/1,500 mm
- flexible probe Ø 12 mm/700 mm
- adapter for hose Ø 6 mm
- adapter for hose Ø 10 mm
- holder for probes and adapters (not mounted on suction unit)



Description	Dimensions cm (l x w x h)	Weight approx. kg	Order no.
KS-Mobil Easy 190 L suction unit with 12 V pump, 40 L/min, and ATEX	80 x 60 x 59	35	11379

### Mobile extraction unit for fuels,

#### 2 stroke mix, diesel and oil

Unit suitable for vehicle and small tank extraction. Suitable for use in potentially explosive atmospheres. Compliant with the Occupational Safety Directive and the 1999/92/EG (ATEX 137) guidelines on workplace health and safety protection.

- complies with the Explosion Protection Directive ATEX 94/9
- 2 m extraction hose and 2 m drain hose
- operation with compressed air, including pressure reducer and maintenance unit
- load bearing surface of the transport trolley suitable for existing canisters or tanks up to 60kg
- earth cable, 3m with clip
- with suction lances Ø 8mm and Ø 12mm
- with adaptors for Ø 6 / 8 / 10mm hoses



Description	Dimensions cm (l x w x h)	Weight approx. kg	Order no.
Mobile extraction unit for fuels, 2 stroke mix, diesel and oil	50 x 50 x 100	19.5	10090

## Used oil collector PG 4

### Mobile used oil collector 80 L

- with collection hopper and fill level display
- emptied using compressed air
- safety valve

Description	Dimensions cm (l x w x h)	Weight approx. kg	Order no.
Mobile used oil collector, 80 L	44 x 49 x 173	25	10692

Mobile used oil collector 80 L



## MOBILE collecting and transport container for hazardous materials (HazMat) PG 4

### Mobile hazardous substance collector GS-MOBILE for flammable liquids with general construction inspection certification no. D/BAM 6744/31A (400 L, 600 L) and D/BAM 6743/31A (980 L) indefinite certification period

The collection, storage and transport container for flammable liquids without a sump/spill pallet (e.g. waste oil of unknown origin, solvents, thinners and many more).

The integrated forklift pockets enable easy and safe transport. An integrated funnel with a dirt sieve and a fixed installed suction pipe with tanker coupling simplify filling and emptying. Can be used by anybody.

Design: explosion shock-proof



Ventilation pipe 2" can be removed for transport



Filling funnel



### GS-MOBILE FOR A I TO A III AND B AS DESCRIBED ABOVE

Capacity L	Dimensions, cm (l x w x h) without ventilation pipe	Dimensions, cm (l x w x h) with ventilation pipe 2"	Weight approx. kg	Order no.
400	96 x 96 x 114	96 x 96 x 310	196	7713
600	96 x 96 x 141	96 x 96 x 300	250	7714
980	121 x 121 x 141	121 x 121 x 300	310	7715



## Go-box for absorbents PG 9

- for granulates, absorbents, etc.
- for indoor and outdoor use and storage
- sturdy rubber wheels
- angled lid so that water runs off
- with eccentric stainless steel latch
- can be locked with a padlock (not included), see page 251
- user-friendly, ergonomic handle
- 70 L capacity
- lid locks open for loading/unloading
- easy to handle thanks to sophisticated balance
- easy to clean
- made of chemical-resistant PE – 100% recyclable
- partition for insertion into the grooves of the Go-box as an accessory

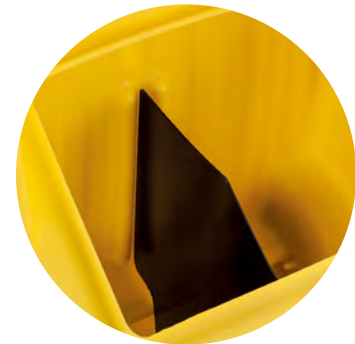

Accessory:  
partition

Description / Volume L	Dimension cm (h x w x d)	Weight approx. kg	Order no.
Go-box 70 for absorbents	107 x 59 x 39	10	11449

### ACCESSORY

Description	Dimension cm (h x w)	Order no.
Partition for Go-box 70	40 x 32	11286

## Portable drum bund / Overpack drum PG 9

### For securing a barrel of up to 210 litres

- safety-tested to UN certification 1H2/X300/S...
- easy unscrewing of lid
- nestable storage in readiness for emergency
- made from high density polyethylene (HDPE) with high resistance to aggressive chemicals
- 300 kg load capacity
- interior dimensions: (top x bottom x height): 68.9 x 64.9 x 99



Description	Dimensions cm outside Ø x h	Collection volume L	Weight approx. kg	Order no.
Overflow	78.7 x 104.7	360	22.5	11023

## Nozzle holder for 60 L and 200 L barrels PG 4

### Nozzle holder for 60 L and 200 L barrels

- holder made from galvanised metal bracket with clamping screws and plastic holster for catching drops
- suitable for attaching to tight-head steel drums and L-ring plastic drums
- easy removal of holster for emptying and cleaning



### ACCESSORY NOZZLE HOLDER FOR BARRELS

Description	Order no.
Nozzle holder for barrels complete with clamping screws and drop holster	11044

## Funnels / collection trays PG 9

### GRP funnel

- with and without lid
- for placing on barrels
- secure seating
- no risk of spillage

### PE collection trays

- with swash edge to prevent content spillage
- pouring spout for transfilling
- robust carrying handles
- acid, chemical, oil and petrol resistant
- sizes 15 L and 58 L sealable, provided with holder(s) for oil filters
- version 58 L also mobile (wheels on one side)
- sizes 20 L and 55 L with a 4-chamber system for safe transportation and for emptying using the 4 edges with spouts



PE collection tray 20 L with GRP funnel without lid



GRP funnel for drum use 60 L and 200 L

GRP funnel with hinged lid



PE collection tray 16 L



PE collection tray 20 L and 55 L



PE collection tray 15 L, sealable



PE collection tray 58 L, sealable

### GRP FUNNEL AND PE COLLECTION TRAYS

Description	Volume L	External dimension cm (l x w x h)	Weight approx. kg	Order no.
① GRP funnel without lid for 200 L drum	-	height 15, ø 56	3	3342
② GRP funnel with hinged lid for 200 L drum	-	height 18, ø 56	5	5348
③ GRP funnel without hinged lid for 60 L drum	-	height 16, ø 39	2.5	5493
④ PE collection tray 16 L	16	59 x 47 x 15	1	10841
⑤ PE collection tray 20 L	20	69 x 44 x 10.5	1.3	6892
PE collection tray 55 L	55	101 x 73 x 12.5	2.8	6891
⑥ PE collection tray sealable 15 L	15.1	51 x 44 x 15.5	1.2	10842
⑦ PE collection tray sealable 58 L	58	92 x 60 x 25	7.6	7908

# CEMSORB ABSORBENTS

## “UNIVERSAL” AND “OIL” PG 9

Cemsorb absorbents are high-performance absorbents to absorb accidentally discharged or spilled hazardous substances without delay or to prevent them from spreading.

### Advantages:

- Cemsorb absorbents absorb up to 18 times their own weight in fluids.
- Cemsorb absorbents are simple and easy to use. Simply place them on the

spilled fluid, and the fluid is quickly absorbed. The area of the accident or the workplace is soon ready to use again.

- Thanks to their high calorific value, they are well suited for thermal utilisation by incineration.

### Cemsorb absorbent “Universal” grey

The Cemsorb absorbent "Universal" was developed to absorb all types of fluids.

We do not recommend using it on water surfaces. Please use the Cemsorb absorbent “Universal” to absorb small quantities of different technical fluids.

### Cemsorb absorbent “Oil” blue

Cemsorb absorbent “Oil” was developed to absorb oil and oil derivatives. Cemsorb oil absorbent is hydroscopic; it does not absorb water.



① Cemsorb cloths „Oil”



② Cemsorb cloth roll “Oil”



③ Multiple Cemsorb cloth rolls “Universal”: both sides reinforced, lint-free and perforated



④ Cemsorb carpet “Oil” Non-slip, dense, reinforced

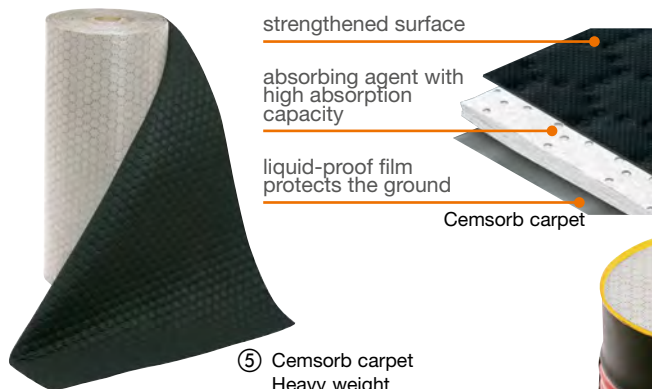

⑤ Cemsorb carpet Heavy weight Non-slip, dense, reinforced



⑥ Cemsorb snake “Oil”

⑦ Cemsorb drum cover “Universal” with reinforced and lint-free surface

Description	Absorption in L / sales unit	Dimension cm	Area m <sup>2</sup> / sales unit	Sales unit	Weight approx. kg / sales unit	Oil (blue or white)	Universal (grey)
						Order no.	Order no.
① Cemsorb cloths Heavy weight Perforated in width direction	113	40 x 50	20	100 cloths / carton	6	8793	8794
② Cemsorb cloth roll Heavy weight Transversely perforated	180	40 x 4000	32	2 rolls / carton	9.6	8795	8796
③ Cemsorb cloth roll Heavy weight Multiply perforated	48	40 x 2500	10	1 roll / dispenser carton	3.5	-	8797
④ Cemsorb carpet „Oil” Heavy weight Non-slip, dense, reinforced	41.3	80 x 120	9.5	10 carpets / carton	4.4	10412	-
⑤ Cemsorb carpet Heavy weight Non-slip, dense, reinforced	103	80 x 3000	24	1 carpet / carton	10.9	-	8798
⑥ Cemsorb pillow filled with flakes	80	Ø 7.5 x 120	-	20 snakes / carton	8	8799	8800
⑦ Cemsorb drum cover	31.5	Ø 56	6.15	25 items / plastic bag	2.1	-	8803



# CEMSORB emergency sets PG 9



Use of the oil suction carpet from the Cemsorb emergency set Agrar



Cemsorb emergency set



Cemsorb emergency box "Universal"



Cemsorb emergency set Agrar



Cemsorb emergency trolley

Description	Capacity	Absorption in L / sales unit	Dimension cm (l x w x h)	Weight approx. kg / sales unit	Oil (blue)	Universal (grey)
					Order no.	Order no.
① Cemsorb emergency set Agrar	1 pair gloves, 2 disposal sacks, 22 oil absorbent cloths 30 x 30 cm white, 1 oil suction snake white 1.20 m x 7.5 cm, 5 wiping cloths, 2 yellow universal cloths 40 x 50 cm, 1 dense oil suction carpet 60 x 80 cm (brown surface)	20	32 x 32 x 16	2	10413	-
② Cemsorb emergency set	1 pair gloves, 2 disposal sacks, 32 cloths 30 x 30 cm, 1 snake 1.20 m x 7.5 cm, 5 wiping cloths	20	32 x 32 x 16	2	8804	8805
③ Cemsorb emergency trolley	1 sturdy PE box (10133), 100 item cloths Universal (8794), 20 snakes Universal (8800), 1 item emergency set Universal (8805)	197	80 x 60 x 53	32	-	10014
④ Cemsorb emergency box	1 sturdy PE box (8615), 100 item cloths Universal (8794), 20 snakes Universal (8800), 1 item emergency set Universal (8805)	197	120 x 60 x 54	35	-	8543



# CONTAINERS FOR TRANSPORT AND STORAGE







# GRP Tanks

CEMO tanks are manufactured from GRP (glass-fibre reinforced plastic) using state of the art technology. The vacuum injection method used enables rationalised manufacturing of widely varying sizes and tank shapes. The finished products have smooth surfaces on both sides and a uniform wall

thickness. Both tank halves are joined together, by a smooth, absolutely leak-free laminate seam, into a single tank unit. CEMO tanks thus guarantee an optimum quality standard, for safe use over many years.

large filling dome for efficient filling and transportation

resistant to chemicals, e.g. ammonia-nitrate-urea solution, pesticides

smooth inner walls, therefore easy to clean

durable weather and corrosion resistant

translucent tank walls for easy level monitoring

up to 70% lighter than steel tanks

GRP is easy to repair



Special drum version with air vent in the dome cover and filling connection with air gap

**INDIVIDUAL ATTACHMENT AND INTEGRATION COMPONENTS WITH A WIDE RANGE OF FITTINGS**



To ensure safer transport, CEMO tanks can also be equipped with baffles.



The CEMO 3-hole flange enables trouble-free mounting of a wide variety of fittings.

CEMO standard tanks are available in oval, trunk and box shapes for a very wide range of applications. From 200 L - 15500 L.



CEMO pasture water tanks have special light protection to prevent algae growth. They have an opaque colour and are thus particularly UV-resistant.



Intended specially for use on Unimog vehicles there are oval or trunk-shaped tanks of 1000 - 5000 L, high-speed versions with baffles also available.



For municipal use, CEMO offers mobile irrigation systems of 1000 - 6000 L with a variety of optional accessories.



Example of use: Sewage disposal from trains belonging to the Deutsche Bahn (German Railways).



## GRP tanks oval PG 8

### Oval tanks made from glass-fibre reinforced plastic, GRP

- for zero-pressure operation
- basic model: filling dome dia. 360 mm with quick closing lid or filling dome dia. 420 mm with flap lid
- vent valves fitted in the lid
- outlet opening with 3-hole flange connection
- fixed support runners attached (high pressure impregnated wood, above 7000 L - steel)
- high-speed model: additional baffles in the top and bottom tank halves



Tank with wooden runners

Pasture water tank with 2 drinking bowls

Capacity L	Dimensions cm (l x w x h) length incl. runners	Dome dia. mm	Weight approx. kg	Order no. / Dome		
				front	centre	rear*
600	137 x 92 x 91	360	40	-	1001	-
750	165 x 92 x 91	360	45	-	1002	-
1000 long	215 x 92 x 91	360	56	-	1003	-
1000 short	146 x 122 x 104	360	57	-	1004	-
1000 high-speed	146 x 122 x 117	420	85	-	1073	-
1500	201 x 122 x 104	360	82	-	1009	-
1600 high-speed	166 x 150 x 138	420	117	-	1076*	-
2000 short	190 x 143 x 138	420	100	-	1824	-
2000 short, with recess	190 x 143 x 138	420	99	-	1065*	-
2000 short, high-speed with recess	190 x 143 x 138	420	126	-	1077	-
2000 long	266 x 122 x 104	360	105	1010	-	1012*
3000	276 x 143 x 138	420	130	1059	-	1060*
4000	366 x 143 x 138	420	173	1061	-	1062*
5000	366 x 154 x 152	420	218	1063	-	1064*
6000	343 x 179 x 170	420	280	5101	-	5102*
7000	400 x 179 x 170	420	401	1025	-	1026*
8500	430 x 188 x 182	420	470	6674	-	6675*
10000	500 x 188 x 182	420	538	3083	-	3120*

Accessories for oval tanks (with 3-hole flange) see page 222-224

### PASTURE WATERING TANKS IMPERMEABLE TO LIGHT AND COLOURED GREY TO PREVENT ALGAE GROWTH

Capacity L	Dimensions cm (l x w x h) length incl. runners	Dome dia. mm	Weight approx. kg	Order no. / Dome		
				front	centre	rear*
600	137 x 92 x 91	360	40	-	1798	-
750	165 x 92 x 91	360	45	-	1049	-
1000	215 x 92 x 91	360	56	-	1050	-
1500	201 x 122 x 104	360	82	-	1051	-
2000 long	266 x 122 x 104	360	105	1052	-	1614*
3000	276 x 143 x 138	420	130	2250	-	2219*
4000	366 x 143 x 138	420	173	2462	-	2218*
5000	366 x 154 x 152	420	218	2463	-	1848*
6000	343 x 179 x 170	420	280	5319	-	5654*
7000	400 x 179 x 170	420	401	1722	-	3179*
8500	430 x 188 x 182	420	470	6681	-	6682*
10000	500 x 188 x 182	420	538	3189	-	3679*

\* Custom version, manufactured to order

### ACCESSORIES FOR PASTURE WATER TANKS

Description	Order no.
 Drinking bowl single	for outlet DN 75
	for outlet DN 100
 Mounting flange for 2 drinking bowls	5790



## GRP tanks trunk-shaped PG 8

### Trunk-shaped tanks

- made from glass-fibre reinforced plastic, GRP
- outlet opening with 3-hole flange connection
- steel support runners

### Advantages of GRP tanks, trunk-shaped:

- optimal utilisation of the loading area
- more transport volume for permissible total weight compared to steel tanks
- remnants discharge

### Tanks for Unimog, Multicar and Pfau:

- filling dome dia. 420 mm and flap lid
- compact shape with vaulted ends (top and bottom)
- baffles in top and bottom tank halves
- vent valves fitted onto the lid
- outlet opening with 3-hole flange connection
- intersecting baffles



Tank 13500 L



Example of tank application



Tank 1800 L



Tank 500 L

Ratchet straps not included

Capacity L	Dimensions cm (l x w x h) length incl. runners	Filling hole / Dome	Weight approx. kg	Order no.
300	102 x 62 x 72	Filling hole dia. 190 mm with screw cap	24	2854
400	133 x 62 x 72		28	2855
500 long	162 x 62 x 72		35	2856
500 short	105 x 95 x 71		41	5944
600	131 x 63 x 102		45	5910
700 with pump sump	146 x 101 x 80	Dome dia. 380 mm with screw cap	54	2857
1000 with pump sump	147 x 101 x 99		58	2858
1800 Flap lid centrally mounted with baffles in upper and lower tank halves	154 x 148 x 128	Dome dia. 420 mm with flap lid	115	7696
2000 with baffles	194 x 102 x 153		135	5115
3000 Flap lid displaced to the side, with transverse baffles	189 x 186 x 124		258	11039
3000 Flap lid displaced to the side, with intersecting baffles	189 x 186 x 124		285	10644
4000 Flap lid displaced to the side, with transverse baffles	191 x 188 x 153		287	11040
4000 Flap lid displaced to the side, with intersecting baffles	191 x 188 x 153		310	10645
5000 Flap lid displaced to the side, with intersecting baffles	231 x 198 x 169		320	6538
8000 Transport tank with baffles	376 x 220 x 179		780	11325
10000 Transport tank with baffles	376 x 220 x 200		810	11326
13500 Storage tank without baffles	506 x 220 x 195		870	8008
13500 Transport tank with baffles	506 x 220 x 195	950	8009	
15500 Storage and transport tank with baffles*	506 x 220 x 222	1.080	8270	















Accessories for trunk-shaped tanks (with 3-hole flange) see page 222-224

# GRP tanks oval and trunk-shaped PG 8

## ACCESSORIES OR OVAL AND TRUNK-SHAPED GRP TANKS, AND TRUNK-SHAPED PE TANKS

Description	Thread	Order no.				
		GRP Tanks oval		trunk shaped	PE Tanks	
		up to 1500 L	1600 L up to 10000 l	8000 L up to 15500 L	600 L up to 1000 L *	2000 L up to 3000 L *
 Lock plate (blank flange) for 3-hole flange, stainless steel	-	1367	1368	1368	1367	1368
 Stainless steel flange plate with threaded nipple for 3-hole flange	¾" ET	5954	5955	5955	5954	5955
	1" ET	1384	1385	1385	1384	1385
	1¼" ET	1386	1387	1387	1386	1387
	1½" ET	1388	1542	1542	1388	1542
	2" ET	1389	1390	-	1389	1390
	3" ET	5614	1391	-	-	-
 Stainless steel flange plate only for 13500 L and 15500 L	4" ET	-	1392	-	-	-
	2" ET	-	-	8177	-	-
	3" ET	-	-	8178	-	-
 Discharge valve, nickel-plated brass with stainless steel flange	4" ET	-	-	11347	-	-
	¾" IT	1316	1317	-	1316	1317
	1" IT	1318	1319	-	1318	1319
	1¼" IT	1320	1321	-	1320	1321
	1½" IT	1322	1323	-	1322	1323
	2" IT	1324	1358	-	1324	1358
	3" IT	1325	1326	-	-	-
 Discharge valve, nickel-plated brass with s/s flange only for 13500 L + 15500 L	4" IT	-	6441	-	-	-
	2" IT	-	-	8179	-	-
	3" IT	-	-	8180	-	-
 PVC ball valve with stainless steel flange	4" IT	-	-	11348	-	-
	1" IT	6447	6453	-	6447	6453
	1½" IT	6449	6455	-	6449	6455
	2" IT	6450	6456	-	6450	6456
 PP ball valve glass-fibre reinforced, with stainless steel flange, (shatterproof version, recommended for liquid manure tanks)	3" IT	6451	6457	-	-	-
	1" IT	6442	6444	-	6442	6444
	1½" IT	1346	1347	-	1346	1347
 PVC ball valve with stainless steel flange only for 13500 L and 15500 L	2" IT	1348	1349	-	1348	1349
	2" IT	-	-	8181	-	-
 PP ball valve with stainless steel flange, only for 13500 L and 15500 L	3" IT	-	-	8182	-	-
	2" IT	-	-	8183	-	-
 Combination valve with painted flange plate brass ¾" and brass 2" valve with C-coupling	-	1578	1579	-	1578	1579
 * Installation kit for flange plate on 2000 L PE tank (required item)	-	-	-	-	8445	8445



## ACCESSORIES FOR OVAL AND TRUNK-SHAPED GRP TANKS

Description		Thread	Order no.
 Double nipple (PVC) with external thread		1"	1527
		1½"	1529
		2"	1530
 Threaded nipple (PVC) with hose nozzle for hose	ø 60 mm	2"	1355
 Kamlok coupling for valves male connection		1½"	1356
		2"	1359
 Kamlok coupling female connection with hose nozzle for hose	inside diameter 40 mm for male connection:	1½"	1357
	inside diameter 60 mm for male connection:	2"	1360
 Kamlok sealing cap	for kamlok coupling, for male connection:	1½"	5266
	for kamlok coupling, for male connection:	2"	1361
 Fire hose coupling C, for valves 2" ET		2"	1340
 Plastic hose with helical reinforcement per m	40 mm I.D.		1363
	60 mm I.D.		1364
 Hose shut-off valve (plastic) for corrugated hose	60 mm I.D.	2"	1681
 Vent cap PVC (sealing cap for screw in / screw through nipples)		2"	1811
 T-piece (PVC) with internal thread		2"	1547
 90° angle, galvanised, IT and ET		2"	1338
 90° angle, PVC, IT		2"	1540
 Pipe coupling (PVC) loose, with internal thread		2"	1535
 Pipe coupling (PVC) laminated attachment, with internal thread		¾"	1752
		1"	1753
		1¼"	1754
		1½"	1755
		2"	1756



# GRP tanks oval and trunk-shaped PG 8

## ACCESSORIES FOR OVAL AND TRUNK-SHAPED TANKS



Description	Order no.
 C-filler coupling 2" with air break, complete with slider, including installation onto tank (factory made)	5689
 Filling sieve with intermediate ring for dome dia. 420 mm	3080
Filling sieve with intermediate ring for dome dia. 360 mm	8241
Filling sieve for dome dia. 380 mm (suitable for GFK tanks trunk-shaped 700 L and 1000 L without baffles)	8628
 1 kg repair pack	neutral 1617
pre-accelerated resin, hardener, glass-fibre, brush	grey 5978
Polyester adhesive pack (1 kg adhesive resin, hardener)	1619

Description	Raw material	Nominal width	Order no.
 DIN flange laminated PN 10/16 comprising pipe socket (laminated to the tank) and loose flange made of PVC	PVC	20	1743
	GRP	25	1744
	GRP	32	1745
	GRP	40	1746
	GRP	50	1747
	GRP	65	1748
	GRP	80	1749
	GRP	100	1750
	GRP	125	2885
	GRP	150	2897
	GRP	200	2898

## STEEL SUPPORT RUNNERS GALVANISED FOR OVAL TANKS, COMPLETE

Model for tank size	Dimensions mm		Weight approx. kg	Order no.
	Section	Length		
	1000 short	U 100 x 50 x 5	1460	surcharge
	1000 long	U 70 x 50 x 4	2150	
	1500	U 100 x 50 x 5	2000	
	2000 short	U 100 x 50 x 5	1900	
	2000 long	U 100 x 50 x 5	2660	
	3000 long	U 100 x 50 x 5 (for order no. 1059, 1060, 2250, 2219)	2755	
	4000 + 5000	U 100 x 50 x 5	3660	
	6000	folded profile 3285 mm	3485	

## CUSTOM EQUIPMENT FOR TANKS IS MADE TO ORDER

Description	Order no.
 Dome dia. 420 mm with flap lid (factory-fitted) with 2 vent valves	opposing dome dia. 360 mm
Dome dia. 420 mm with screwed on flat lid (factory-fitted)	surcharge in exchange for dome dia. 360 mm
	surcharge in exchange for dome dia. 420 mm with flap lid
 Baffles for fast vehicles in two tank halves	for sizes up to 5000 L (2 off)
	for sizes 6000 - 7000 L (2 off)
	for sizes 8500 - 10000 L (4 off)

## CUSTOM VERSIONS

Painting tanks in special colours (quote RAL no., colour similar to RAL, only for tanks manufactured by vacuum injection method)	surcharge on request
--	----------------------

## PE tanks PG 8

### PE beverage tanks







- in food-safe HD-PE
- low outlet with tap DN 19
- with screw cap, diameter 220 mm
- with 2 handles (for transporting when empty)
- the sealing cap can be fitted instead of the outlet tap
- optional adapter with 1" external thread or 1 ½" external thread (see accessory)



Description	Capacity L	Dimensions cm (l* x w x h*)	Weight approx. kg	Order no.
PE beverage tank 60	60	55 x 35 x 57	3.5	8886
PE beverage tank 100	100	63 x 42 x 67	5.5	8887
PE beverage tank 150	150	73 x 45 x 74	8.5	8888
PE beverage tank 200	200	84 x 48 x 81	11	8889
PE beverage tank 300	300	91 x 59 x 89	13.5	8890
PE beverage tank 500	500	106 x 73 x 103	21	8891

\* Length with outlet tap, height with lid and sealing plug.

### ACCESSORIES AND SPARE PARTS

Description	Order no.
 Screw cap, dia. 220 mm with sealing plug	8892
 Sealing plug	8893
 Outlet tap DN 19	8894
 Adapter with 1" external thread	8895
 Adapter with 1 ½" external thread	8896
 Outlet tap brass, nickel-plated with 1" internal thread	1304
 Outlet tap brass, nickel-plated with 1 ½" internal thread	1306

## PE tanks trunk-shaped PG 8

- made of high quality, age-resistant and recyclable polyethylene.
- manufactured in one piece using centrifugal moulding
- space-saving, trunk-shaped design
- low centre of gravity
- footprint for the 600 L tank matched to Euro-pallet dimensions
- 2000 L tank fits across a Unimog load-bed
- 2" internal thread connection with indentation on the end (600-2000 L tanks)
- discharge opening with 3-hole flange connection and indentation (3000 L tank)
- 2" internal thread connection options on the long sides (2000 L + 3000 L tank)
- option of installing the proven CEMO 3-hole flange onto the 2000 L tank
- 1" internal thread fitting for complete drainage
- 380 mm diameter dome with swash baffle and hinged cover
- vent valve installed on the hinged cover
- handles and lugs for tensioning belts
- integral securing flange for direct mounting on the vehicle loadbed

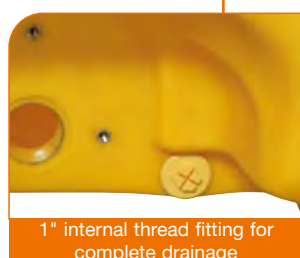

PE pasture watering tank, trunk-shaped, impermeable to light and coloured green to prevent algae growth.

### PE TANKS TRUNK-SHAPED COLOURED YELLOW

Capacity L	Dimensions cm (l x w x h)	Filling hole / Dome dia. mm	without baffles		with baffles	
			Weight approx. kg	Order no.	Weight approx. kg	Order no.
600	120 x 90 x 90	ø 380 with flap lid	35	8273	41	10921
1000	145 x 114 x 100		54	8274	62	10922
2000	190 x 135 x 117		82	8275	93	10923
3000	240 x 150 x 117		138	11510	166	11511

### PE PASTURE WATERING TANK TRUNK-SHAPED IMPERMEABLE TO LIGHT AND COLOURED GREEN TO PREVENT ALGAE GROWTH

Capacity L	Dimensions cm (l x w x h)	Filling hole / Dome dia. mm	without baffles		with baffles	
			Weight approx. kg	Order no.	Weight approx. kg	Order no.
600	120 x 90 x 90	ø 380 with flap lid	35	8884	41	10924
1000	145 x 114 x 100		54	8885	62	10925
2000	190 x 135 x 117		82	8381	93	10926
3000	240 x 150 x 117		138	11512	166	11513

\* Accessory installation kit 8445 required (see page 222).



## ACCESSORIES FOR PE TANKS, TRUNK-SHAPED







Description	Thread	Order no.
 PP adapter set (PP reducing nipple + PP reduction)	2" ET to ¾" ET	8406
 PP reducing nipple	2" x 1" ET	8407
	2" x 1 ½" ET	8408
 PP double male connector	2" ET	8409
 PP plug	2" ET	8410
 Filling sieve dia. 380 x h 330 mm		8628
 Drainage valve (brass, nickel plating) with internal thread on both sides	¾"	1303
	1"	1304
	1 ½"	1306
	2"	1307
 Plastic ball valve (PVC) with internal thread	1"	6426
	1 ½"	6428
	2"	6429
 Plastic ball valve (polypropylene, fibreglass-reinforced) with internal thread	1"	1310
	1 ½"	1312
	2"	1313
 C-filler port 1 ½" with air break, complete with gate valve, including assembly, for optional C-filler port 2" for PE tank 3000 L, see page 224		11045
 Galvanised steel frame, forklift accessible from four sides	for PE tank 600 L, trunk-shaped	11514
	for PE tank 1000 L, trunk-shaped	11515
	for PE tank 2000 L, trunk-shaped	11516
	for PE tank 3000 L, trunk-shaped	11517

Fig. 11517

Additional accessories see page 222.

## ACCESSORIES FOR PE PASTURE WATERING TANK

Description	Order no.	
 Single attached drinking trough *	600 L	1056
	1000 L	
		2000 L
 Mounting flange for 2 drinking troughs *	5790	
 Example: In conjunction with the optional side outlets on the 2000 L PE tank, a maximum of 6 attached drinking troughs is possible with order no. 1056 and 5790. Frame with the minimum dimensions 149 x 120 x 16 cm (l x w x h) required (additional item).		

\* Accessory installation kit 8445 required (see page 222).

## Tanks box-shaped PG 8

### Box-shaped tanks made from glass-fibre reinforced plastic, GRP.

- flat bottom, so no support runners necessary
- strong, all-round gripping rim



### GRP TANKS BOX-SHAPED

Description / capacity L	Dimensions cm (l x w x h)	Filling hole / Dome ø in mm	Weight approx. kg	Order no.
Box-shaped tank, GRP, 200 L	87 x 57 x 57	Filling hole dia. 190 mm with screw cap	12	1043
Box-shaped tank, GRP, 400 L	122 x 62 x 72		19	1045
Box-shaped tank, GRP, 600 L	118 x 70 x 106		30	7958

### Tanks, trunk-shaped made from high-quality, hard-wearing, recyclable polyethylene

- 125 L, 200 L, 450 L or 600 L
- manufactured in one piece using centrifugal moulding
- with S160x7 screw cap
- screw cap with integrated vent and pressure relief
- filling hole internal diameter 140 mm
- integrated recesses for securing with ratchet straps during transport
- integral forklift pockets and handles
- integral baffle with 450 L and 600 L models
- 2-tier stackable, with stacking cams
- ideal dimensions for transportation



Various sizes from 125 L to 450 L (600 L not illustrated)

With outlet tap accessory



Stackable, with stacking cams, integral forklift slots and handles

### PE TANKS BOX-SHAPED, COLOURED YELLOW



Description / capacity L	Dimensions cm (l x w x h)	Weight approx. kg	Order no.
Box-shaped tank, PE, 125 L	80 x 60 x 45	15	10095
Box-shaped tank, PE, 200 L	80 x 60 x 59	16	10096
Box-shaped tank, PE, 450 L	116 x 76 x 73	35	10097
Box-shaped tank, PE, 600 L	116 x 76 x 102	43	10098

## ACCESSORIES FOR BOX-SHAPED TANKS, GRP AND PE

Description	Thread	without installation	with installation on the tank
		Order no.	Order no.
 <p>Screw through threaded connector* (brass) with external thread, 2 lock nuts</p>	3/4"	1393	8843
	1"	1394	8844
	1 1/4"	1395	8845
	1 1/2"	1396	8846
 <p>Screw in threaded connector* (brass, nickel-plated) with external thread, food safe</p>	3/4"	1397	8847
	1"	1398	8848
	1 1/4"	1399	8849
	1 1/2"	1500	8850
 <p>Screw in threaded connector *** (plastic) with external thread</p>	3/4"	10910	10915
	1"	10911	10916
	1 1/4"	10912	10917
	1 1/2"	10913	10918
 <p>Screw in threaded connector* (plastic) with external and internal threads</p>	2"	10914	10919
	ET 1" IT 1/2"	1515	8852
	ET 1 1/4" IT 3/4"	1516	8853
	ET 1 1/4" IT 1"	1517	8854
 <p>Discharge valve (brass, nickel-plated) with internal thread at both ends</p>	ET 2" IT 1 1/2"	1518	8855
	ET 2 3/4" IT 2"	1519	8856
	3/4"	1303	
	1"	1304	
	1 1/4"	1305	
 <p>Plastic ball valve (PVC) internally threaded</p>	1 1/2"	1306	
	2"	1307	
	1"	6426	
	1 1/2"	6428	
 <p>Plastic ball valve (polypropylene, glass-fibre reinforced) internally threaded</p>	2"	6429	
	3"	6430	
	1"	1310	
 <p>Spindle valves (plastic) with ET matched to screw in threaded connector</p>	1 1/2"	1312	
	2"	1313	
	1/2"	1314	
 <p>Spindle valves (plastic) with ET matched to screw in threaded connector</p>	3/4"	1315	

\* Not for PE trunk-shaped tank 125 L \*\*\* only for box-shaped tanks PE

## ACCESSORIES FOR BOX-SHAPED TANKS, GRP

Description	Order no.		
 <p>Screw cap dia. 190 mm compl. with screws (upgrade kit)</p>	6492		
Description	Steel base frame for size	Weight approx. kg	Order no.
 <p>Steel base frame, galvanised, for safe support</p>	200	10	7784
	400	12	7785
	600	12	7787



# Mobile irrigation system BWS 500 PG 8

Mobile irrigation system BWS 500 for vehicle load-beds or stationary operation

### Oval tanks:

- made from glass-fibre reinforced plastic, GRP
- models above 4000 L with baffles
- with extended steel runners
- mounting bracket for pump installation
- stainless steel flange plate with threaded nipple 2"
- filling dome dia. 360 mm with quick closing lid, capacity up to 1500 L
- filling dome dia. 420 mm with flap lid above 2000 L
- vent valves fitted in the lid
- Example application:  
Suitable for professional irrigation of large areas and parks and thus the ideal system for municipal or commercial users.



Ratchet straps not included in the kit

Example: foldable hose reel

## TANKS OVAL WITH EXTENDED STEEL RUNNERS AND PUMP BRACKET

Capacity L	Dimensions cm (l x w x h) length incl. runners	Dome dia. mm	Weight approx. kg	Baffle quantity	without hose reel, without pump	
					Order no.	
1000	206 x 122 x 104	360	160	-		7135
1500	270 x 122 x 104	360	190	-		7136
2000	247 x 143 x 138	420	205	-		7137
3000	325 x 143 x 138	420	267	-		7468
4000	418 x 143 x 138	420	310	2		7138
5000	418 x 154 x 155	420	356	2		8624
6000	395 x 179 x 170	420	410	2		7139

Special sizes on request



## ADD-ON PARTS: PUMPS AND HOSE REELS

DEPENDENT ON THE APPLICATION, THE IRRIGATION TANK SYSTEMS CAN BE ASSEMBLED FROM THE COMPONENTS LISTED BELOW. THE EQUIPMENT TANK IS SUPPLIED COMPLETELY ASSEMBLED.

Description	suitable for equipment tanks	Order no.
① Motorized pump 500 L/min with petrol engine Integrated pump, with suction and pressure connections switchable using 3-way valves	all sizes	10540
② Pump 100 to 350 L/min (not self-priming), with hydraulic motor including flow control valve, permanently installed, with suction pressure connection, adjustable via 3-way valves		10541
③ Pump up to 60 L/min, 24 V / 19 A / DC, with switch and plug, pump permanently installed, with 1" suction and pressure connection, convertible via 3-way valve		10861
④ Swivel-mounted hose reel, vertically adjustable 145 mm (with connection hose to the pump) for 80 m water-hose ¾" or 35 m water hose 1" * (accessory)		10542
⑤ Automatic hose reel with spring-loaded retraction Painted steel, swivelling (with connecting house to the pump), for 40 m water hose ¾" or for 30 m water hose 1" *(accessory)		10862
⑥ Foldable hose reel for high vehicles (without hose) securely mounted; for 80 m water-hose ¾" or 35 m water hose 1" *		10543

\* Please note that the pump output can fall sharply depending on the length and cross-sectional area of the hose.

Other pumps on request.

Further accessories see page 222 and 224.

## ACCESSORIES FOR MOBILE IRRIGATION SYSTEM BWS 500

Description	suitable for equipment tanks	Order no.
Factory fitted	1000 L	6814
	1500 L up to 5000 L	7146
	6000 L	7147
	C-filling coupling with free flowing path, complete with slider for tank filling	5689
Supplied unassembled	PVC pressure hose, dia. 60 mm, length 3.5 m; C-coupling at both ends, can also be used to extend the suction hose	5774
	PVC suction hose, dia. 60 mm, length 3.5 m; with strainer and C-coupling at one end	5775

## Mobile irrigation system BWS 130 PG 8

### Mobile irrigation system BWS 130

- light and robust construction
- simple handling due to low weight
- suitable for all oval tanks of 600 - 5000 L capacity (see page 220)
- hose reel can be swivelled through 135° (without hose) accepts 80 m water hose ¾" or 35 m water hose-1"
- pre-assembled unit
- Example application:  
Suitable for irrigating green spaces and parks. This system offers an optimum price-performance ratio for gardening and landscaping service providers as well as for many other service providers (e.g. building cleaning).

Accessories see page 233.



Ratchet straps not included in delivery

### BWS 130 COMPLETE WITH TANK, ADD-ON PUMP AND HOSE REEL

Capacity L	Overall dimensions cm (l x w x h)	Total weight approx. kg	Order no. without baffles*
600	207 x 92 x 96	115	7914
750	235 x 92 x 96	120	7915
1000 long	285 x 92 x 96	131	7916
1000 short	216 x 122 x 104	132	7917
1500 short	271 x 122 x 104	157	7918
2000 short	260 x 143 x 138	175	7919
2000 short with recess	260 x 143 x 138	174	7920
2000 long	336 x 122 x 104	180	7921
3000 short with recess	301 x 154 x 152	255	7922
3000	346 x 143 x 138	205	7923
4000	436 x 143 x 138	248	7924
5000	436 x 154 x 152	296	7925

\* baffles see page 224

### ADD-ON PUMP WITH HOSE REEL (FOR RETROFITTING EXISTING TANKS)

Description	Dimensions cm (l <sup>1</sup> x w x h)	Total weight approx. kg	Order no.
 <p>Add-on pump consisting of:</p> <ul style="list-style-type: none"> <li>• Honda pump (petrol engine), self-priming, output rate approx. 130 L/min, pump capacity up to 3.5 bar *</li> <li>• hose reel (without hose)</li> <li>• mounting bracket pre-assembled</li> </ul>	70 x b <sup>2</sup> x 96	75	7740

Accessories see page 233.

<sup>1</sup> = increase in tank length <sup>2</sup> = maximum tank width



## Mobile irrigation system BWS 130-PE PG 8

The irrigation system enables:

- irrigation: circuit with a safety inlet valve before the pump
- tank can be filled at a standpipe via the 3-way valve system (7 m hose included)
- mixing of optional additives possible using closed circuit in the tank (e.g. fertilisers, pesticides)

BWS 130-PE consisting of:

- frame and mounting surface made from galvanised steel (with mounting points)
- Honda pump with petrol engine 130 L/min\* output rate
- pivotable hose reel (without hose) for 80 m water hose ¾" or 35 m water hose 1"

- pressure relief valve to protect the motorised pump
- ratchet straps
- frame with bi-directional forklift pockets
- version with optional baffles available, see below



Setup and securing of the ratchet strap

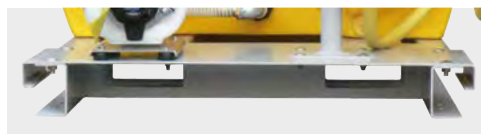

Bi-directional forklift pockets front and back



Forklift pockets at the side

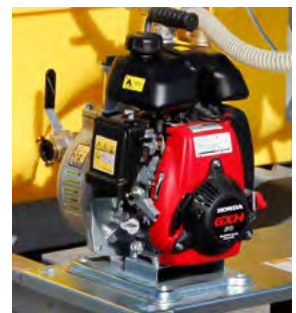

Honda pump with petrol engine  
130 L/min

### MOBILE IRRIGATION SYSTEM BWS 130-PE WITH PETROL ENGINE PUMP

Capacity L	Dimensions cm (l x w x h)	Filling hole / Dome ø in mm	without baffles		with baffles	
			Weight approx. kg	Order no.	Weight approx. kg	Order no.
600	184 x 90 x 96	dia. 380 with flap lid	135	8684	141	10927
1000	208 x 114 x 104		160	8685	168	10928
2000	263 x 135 x 124		212	8686	223	10929
3000	291 x 150 x 127		308	11518	336	11519

For the description of the trunk-shaped PE tank, see page 226.

**Accessories see page 227 and 233. Further pumps on request.**

\* Please note that the pump output can fall sharply depending on the length and cross-sectional area of the hose.



# Mobile irrigation system BWS 130-PE with electric pump PG 8

- version with pump 12 V or 24 V, 60 L/min
- the quiet alternative for mobile irrigation of plants in residential areas, parks and cemeteries
- optionally available with lithium-ion battery (charger incl.) for totally mobile, cable-free operation
- mixing of optional additives (e.g. fertiliser, pesticides) possible using closed circuit in the irrigation system
- galvanised steel frame forkliftable from four sides
- pivotable hose reel (without hose) for 80 m 3/4" water hose or 35 m 1" water hose
- version with optional baffles available, see below





BWS 130-PE  
3000 L with pump 24 V  
and Li-Ion battery



## MOBILE IRRIGATION SYSTEM BWS 130-PE WITH ELECTRIC PUMP

Description	Dimensions cm (l x w x h)	Dome ø mm	without baffles		with baffles	
			Weight approx. kg	Order no.	Weight approx. kg	Order no.
600 L with pump 12 V	184 x 90 x 96	ø 380 with flap lid	130	11520	136	11532
600 L with pump 24 V	184 x 90 x 96		130	11521	136	11533
600 L with pump 24 V and Li-Ion battery	184 x 90 x 96		142	11522	148	11534
1000 L with pump 12 V	208 x 114 x 104		147	11523	155	11535
1000 L with pump 24 V	208 x 114 x 104		147	11524	155	11536
1000 L with pump 24 V and Li-Ion battery	208 x 114 x 104		159	11525	167	11537
2000 L with pump 12 V	263 x 135 x 124		205	11526	216	11538
2000 L with pump 24 V	263 x 135 x 124		205	11527	216	11539
2000 L with pump 24 V and Li-Ion battery	263 x 135 x 124		217	11528	228	11540
3000 L with pump 12 V	291 x 150 x 127		301	11529	329	11541
3000 L with pump 24 V	291 x 150 x 127		301	11530	329	11542
3000 L with pump 24 V and Li-Ion battery	291 x 150 x 127		313	11531	341	11543

## ACCESSORIES FOR MOBILE IRRIGATION SYSTEM BWS 130, BWS 130-PE AND BWS 500 (SUPPLIED UNASSEMBLED)

Description	Order no.
 Spray lance with GEKA-coupling and lever valve	5826
 Watering shower head with rubber edge R 3/4", max. 80 L/min	10045
Water hose per metre	3/4" 5889
	1" 5855
 GEKA-coupling with hosetail	3/4" 10765
	1" 10766
Hose clamp 25 - 40 mm, stainless steel	8249

\*\*\* Available only in combination with a mobile irrigation system.

## Mobile irrigation system BWS 25-PRO PE PG 8

for professional use

### BWS 25-PRO PE comprising:

- PE tank box-shaped, with integrated baffles (see page 236)
- gear pump 12/24 V, IP 67, output rate 25 l/min\*, delivery pressure 3 bar, with automatic switch-off function

- 4 m cable with crocodile clips
- quick coupling with water stop for Gardena irrigation system
- 10 m water hose 3/4"

BWS 25-PRO PE with gear pump 12/24 V, GEKA quick coupling and professional spray lance (optional)



Description	Capacity L	Dimensions cm (l x w x h)	Weight approx. kg	Order no.
BWS 25-PRO PE, 450 L	450	116 x 76 x 83	38	11332
BWS 25-PRO PE, 600 L	600	116 x 76 x 112	46	11333

## ACCESSORIES

Description	Order no.
 Professional spray lance with sprinkler head GEKA 20 - 35 L/min	11334

## Mobile irrigation system BWS 30-PE PG 8

for personal use

- PE tank box-shaped, with integrated baffles (see page 228)
- submersible pump CENTRI SP30, 12 V, output rate 30L/min (free flow)\*, delivery pressure 1 bar
- 4 m connection cable with crocodile clips
- quick coupling with water stop for Gardena irrigation system
- 10 m water hose 1/2"



BWS 30-PE, 450 L (spray lance not included, optional accessory)



**CENTRI SP30**  
EXTREMELY  
QUIET



BWS 30-PE with submersible pump CENTRI SP 30 and quick coupling for Gardena irrigation system

Description	Capacity L	Dimensions cm (l x w x h)	Weight approx. kg	Order no.
BWS 30-PE, 125 L	125	80 x 60 x 45	17	11312
BWS 30-PE, 200 L	200	80 x 60 x 59	18	11313
BWS 30-PE, 450 L	450	116 x 76 x 73	37	10596
BWS 30-PE, 600 L	600	116 x 76 x 102	45	10597

## ACCESSORY

Description	Order no.
Spray lance with watering shower head	10598

## Aqua-Caddy PG 8

### Aqua-Caddy 60 L

- submersible pump CENTRI SP 30, delivery rate 30 L/min (free flow\*), delivery pressure 1 bar
- Li-Ion CAS battery 18 V, 2 Ah with charger
- quick-coupling with water stop for Gardena irrigation system
- 6 m water hose 1/2"
- spray lance with spray head

**NEW**



**CENTRI SP30**  
EXTREMELY  
QUIET



### Aqua-Caddy 60 L for concrete drilling machines

- oscillating piston pump 230 V, duty cycle 100 %
- delivery rate max. 3.5 L/min
- 6 m cable with switch
- 3 m dispensing hose with Gardena coupling



Description	Capacity L	Dimensions cm (l x w x h)	Weight approx. kg	Order no.
with submersible pump CENTRI SP 30	60	90 x 52 x 37	15	10847
with oscillating piston pump	60	90 x 52 x 37	15	11032

\* Please note that the pump output can fall sharply depending on the length and cross-sectional area of the hose.

## Transfer trolley Aqua 130 L PG 8

**NEW**

### The practical solution for watering plants in administrative buildings, hotels and hospitals

- for transporting water and for independent watering of plants
- totally mobile and wireless
- no need to lug watering cans
- 130 L container made of high-quality translucent polyethylene, with integrated handles and fill-level scale
- low centre of gravity
- integral pump sump allows the container to be emptied almost entirely
- equipped with 4 swivel castors  $\varnothing$  100 mm



### ① Version with electric pump:

- Quick coupling with water stop for Gardena irrigation system
- hand sprayer with flow control
- equipped with self-priming pump, 11 L/min, with pressure switch, CAS battery and charger

### ② Version with hand pump:

- hand pump, 0.4 L/stroke
- 2 m water hose
- manual nozzle



Description	Dimensions cm (l x w x h)	Weight approx. kg	Order no.
① 130 L with 12V pump, CAS battery, charger and sprinkler	50 x 75 x 101	24	11544
130 L supplied <b>without CAS battery and charger</b>	50 x 75 x 101	24	11674
② 130 L with hand pump and manual nozzle	50 x 75 x 114	22	11570

## Mobile sprayers PG 8

### Canister pump set, 230 V

Pump can be screwed directly onto canisters with DIN 61 thread. Spray lance with flat spray nozzle, size 04, spray angle 110°, approx. 950 mL/min, and flat spray nozzle, size 02, spray angle 110°, approx. 690 mL/min output rate



### Container sprayer, 230 V

Spray lance with flat spray nozzle, size 04, spray angle 110°, approx. 1,040 – 1,370 mL/min, and flat spray nozzle, size 02, spray angle 110°, approx. 800 – 1,000 mL/min output rate



### Spray caddy 60 L, 12 V

Battery capacity 3.3 Ah, suitable for approx. 60 L (with nozzle 03). Spray lance with flat spray nozzle, size 03, spray angle 110°, approx. 1,150 mL/min, and flat spray nozzle, size 02, spray angle 110°, approx. 800 mL/min output rate

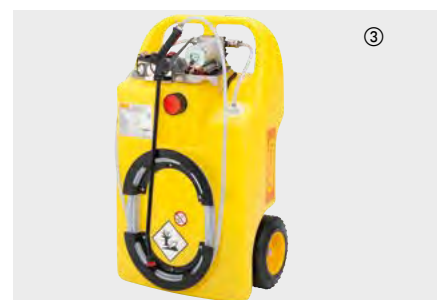

Description	Dimensions cm (l x w x h)	Order no.
① <b>Canister pump set, 230 V</b> with 20L PE canister and 5m reinforced hose	29 x 25 x 57	7898
② <b>Container sprayer, 230 V</b> 20L container capacity, 5m reinforced hose	56 x 21 x 38	11356
③ <b>Spray caddy 60 L, pressure relief valve 0.3 - 5 bar, 8m reinforced hose, LiFePO<sub>4</sub> battery with charger</b>	90 x 52 x 37	11359

### ACCESSORIES

	<b>Adapter set</b> for canister pump set Adapter to 2" thread, DIN 51 and DIN 71, and longer suction hose with foot filter	11362
	<b>Spare battery</b> for spray caddy 60 L Lithium-iron phosphate battery (LiFePO <sub>4</sub> ), 12.8 V – 3.3 Ah	10602



# Mobile cleaning and weed control system

## MCS 1000 HD PG 8

The mobile cleaning and weed control system enables you to work independently of electricity and mains water.

It consists of the following components:

- 600 L, 1000 L or 2000 L PE tank with baffle
- runners and frame made from galvanized steel (with mounting points)
- frame with integral forklift pockets on both sides and at the front
- ratchet straps
- heated Kärcher high-pressure module HDS 1000 De (diesel operation) with high-pressure gun
- hose reel with 20 m of high-pressure hose (optional)
- hose reel with 40 m of high-pressure hose (optional)
- cleaning gun
- with weed control attachment kit

(temperature sensor). This ensures a constant water temperature of 98 °C at the outlet of the weed control lance

- weed control lance for weed removal without chemicals (optional)



MCS 1000 HD  
with PE tank 1,000 L

MCS 1000 HD  
**3 in 1**

mobile and effective

**Weed control** with hot water at 98 °C

**High-pressure cleaning** up to 200 bar

**Disinfection** with steam up to 150 °C

### Technical data for high-pressure module HDS 1000 De

Pressure	40-200/4-20 bar/MPa
Fuel oil consumption at full load	5.6 kg/h
Output rate	450-900 l/h
Engine power	6.8/9.3 kW/HP
Engine type	L 100 V Diesel
Engine manufacturer	Yanmar
Max. temperature (supply temp.: 12 °C) for weed control	80-98 °C
Max. temperature (supply temp.: 12 °C) when operated with steam	up to 150 °C



High-pressure module HDS 1000 De



High-pressure cleaning up to 200 bar



Weed control with weed lance WR 10



Before

After











MCS 1000 HD  
with PE tank 1,000 L, with hose reel (accessory)  
and weed control lance (accessory)

## MOBILE CLEANING AND WEED CONTROL SYSTEM MCS 1000 HD

Capacity L	Dimensions cm (l x w x h)	Dome ø mm	Weight approx. kg	Order no.
600	203 x 113 x 96	ø 380 with lid	297	11314
1000	228 x 113 x 104		322	11315
2000	273 x 135 x 124		372	11316

## ACCESSORIES

	Description	Dimensions cm (l x w x h)	Weight approx. kg	Order no.
	10 m of high-pressure hose DN8 40 MPa	-	3.5	11355
	Hose reel with 20 m of high-pressure hose DN8 40 MPa	45 x 19 x 46	20	11317
	Hose reel with 40 m of high-pressure hose DN10 22 MPa	52 x 49 x 58	52	11318
	Weed control lance WR 50	24 x 50 x 26	1.6	11319
	Weed control lance WR 10	10 x 10 x 10	0.6	11509
 	Pressure and flow regulator for cleaning gun MCS <b>NEW</b>	-	-	11702
	Descaling agent RM 110, 1 litre	-	1.2	11552

## Polyethylene storage tanks PG 8

- **Storage tanks and large reservoirs:** for above ground installation in the garden or for trade and industry
- can be used as water butts for garden watering
- protect the water against subsequent dirt collection
- manufactured from high-quality polyethylene
- the green containers are opaque so as to limit algae growth
- can be completed by the addition of custom equipment so they fulfil particular purposes
- can also be installed as a tank battery (except storage tank 5000 L).
- **Storage tanks:** food safe (except storage tanks 1000 L and 5000 L) meet the requirements of the German Environment Agency for plastics in drinking water.
- **Large reservoirs:** are primarily for commercial water use, e.g. in market gardens, washing installations and industrial concerns, but are also suited to rain water storage in the domestic market.



Storage tank 750 L with 3 x 2" connections and 1 flange connection

Storage tank 1000 L with large inspection dome, 1 x 2" connection and 1 flange connection



Storage tanks with large inspection dome, 2 x 2" connections and flange connection (1100, 1500 and 2000 L with steel bands)



Large reservoir with large inspection dome, 1 x 2" connection and 2 flange connections (2000 and 3000 L)











Storage tank 5000 L with 3 x 2" connections and 1 connection S 160 x 7

Description / capacity L	Dimensions cm (l x w x h)	Inspection dome dia. mm	Weight approx. kg	Order no.	
Storage tanks	750	74 x 74 x 164	140	25	7848
	1000	124 x 72 x 125	500 x 400	40	7649
	1100*	145 x 72 x 134	400	53	8315
	1500*	152 x 72 x 161	400	66	7650
	2000*	201 x 72 x 164	400	92	7651
	5000*	239 x 135 x 198	140	240	8317
Large reservoirs	2000	202 x 88 x 165	500 x 400	95	7652
	3000	263 x 88 x 165	500 x 400	130	7653

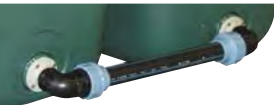
\* with steel bands



## ACCESSORIES FOR STORAGE TANKS 750 L UP TO 2000 L AND LARGE RESERVOIR

Description	suitable for								Order no.
	Storage tanks					Large reservoir			
	750 L	1000 L	1100 L	1500 L	2000 L	2000 L	3000 L		
 <p>Flange with ball valve 1"</p>	X	X	X	X	X	X	X	7654	
 <p>Mechanical filling level indicator</p>	X				X	X	X	7655	
 <p>Screw connection for submersible pump</p>	X	X	X	X	X	X	X	7656	
 <p>Connection line 2"</p>	X	X	X	X	X	X	X	7657	
 <p>Floating extractor</p>			X	X	X	X	X	7658	
 <p>Universal flange connector elbow 1"</p>	X	X	X	X	X	X	X	7659	
 <p>Universal flange connector T-piece 1"</p>	X	X	X	X	X	X	X	7660	
 <p>Universal flange connector elbow 2"</p>	X	X	X	X	X	X	X	7661	
 <p>Universal flange connector T-piece 2"</p>	X	X	X	X	X	X	X	7662	
 <p>Flange connection 1"</p>	X	X	X	X	X	X	X	7736	
 <p>Flange connection 2"</p>	X	X	X	X	X	X	X	7737	

Accessories for storage tank 5000 L on request.

# Rectangular containers, GRP

Rectangular containers made from glass-fibre reinforced plastic, GRP. For wherever transport and storage containers with particularly high strength, low weight and extreme resistance to corrosion are required.

- ✓ sizes 100 L to 4500 L
- ✓ reinforced handling rim
- ✓ corrosion resistant and extremely light
- ✓ very strong and rigid
- ✓ stackable
- ✓ UV-resistant
- ✓ smooth inside and outside surfaces for easy cleaning
- ✓ various transport accessories, e.g. removable foot and castor support frame with centering lugs



can be driven under

Integrated forklift pockets for pallet truck and forklift (200 L and 400 L).



stackable

“Sideways stackable” for space-saving storage and easy separation.

Can be stacked with closed stacking lid (200 L and 400 L).



## Our PREMIUM product line GRP



Due to the excellent material properties created by reinforcing the three-dimensionally meshed duroplastic material with glass-fibres, GRP has been used for decades to make high-performance products that are expected to have a long service life in tough environments and at the same time ensure high levels of safety. GRP combines the positive properties of steel and plastic.



flat lid

GRP lids are available for each rectangular container ranging in size from 100 L to 4500 L. For large containers of 4500 L also with integrated locking lid with Ø 380 mm.



smooth surfaces and reinforced handling rim

Less dirt thanks to smooth external walls (dirt not able to build up); no residues left behind after draining and easy to clean thanks to smooth internal walls in the container. The reinforced edge prevents any deformation and therefore a high-precision fit for the seal of the optional lid. It also guarantees excellent inherent rigidity, even with heavy contents.

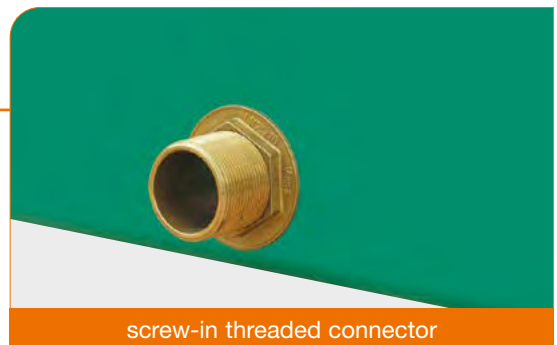

screw-in threaded connector

Screw-in threaded connector and screw-through threaded connector as well as drain taps are available as accessories.



forklift pockets

The forklift pockets are mounted impervious to fluids and suitable for rotary forklifts.



castor frame

Accessory: castor frame with centering lugs.



steel base frame

Accessory: steel base frame with centering lugs.



## Rectangular containers PG 8

### Containers with forklift pockets:

- forklift pockets attached in a leak-proof manner using stainless steel coach bolts
- suitable for rotary forklifts, insertion dimension of forklift pockets 160 x 70 mm

### Large container:

- container (grey) from GRP
- for use as a storage and collection container
- chemical-resistant
- can be installed above ground as well as below ground level
- hot dip galvanised external braces for above ground installation
- stainless steel internal braces for installation in the ground



Rectangular container, for example with castor frame (accessory)



Large container: Hot dip galvanised external braces for above ground installation. Stainless steel internal braces for installation in the ground.

Capacity L		Internal dimensions cm top (l x w x h)	External dimensions cm top (l x w x h)	Weight approx. kg	Order no. green	Order no. grey	Order no. blue
100	standard	80 x 50 x 28	88 x 58 x 29	5	1142	7165	7567
200	flat standard	115 x 55 x 36	122 x 62 x 37	8	1143	5671	7568
200	high standard	80 x 49 x 59	88 x 57 x 60	8	1144	1160	7569
300	standard	110 x 62 x 52	118 x 70 x 53	14	1145	1161	7570
300	with forklift pockets	110 x 62 x 52	117 x 69 x 60	26	1204	7178	-
400	standard	111 x 71 x 59	119 x 79 x 60	17	1146	1162	7571
400	with forklift pockets	111 x 71 x 59	119 x 79 x 67	30	1205	7179	-
500	flat standard	144 x 79 x 50	153 x 88 x 50	18	1156	7166	-
550	standard	118 x 83 x 62	132 x 97 x 63	19	1147	1163	7995
550	with forklift pockets	118 x 83 x 62	132 x 97 x 70	34	1206	7180	-
700	standard	118 x 83 x 80	132 x 97 x 81	23	1148	1164	7996
700	with forklift pockets	118 x 83 x 80	132 x 97 x 88	38	1207	2554	-
1100	standard	148 x 105 x 80	162 x 119 x 81	36	1150	1165	7997
1100	with forklift pockets	148 x 105 x 80	162 x 119 x 88	57	1208	2555	-
1500	standard	168 x 125 x 80	182 x 139 x 81	46	1151	1166	-
1500	with forklift pockets	168 x 125 x 80	182 x 139 x 88	64	1209	2642	-
2200	standard	197 x 134 x 92	211 x 148 x 93	65	1152	1167	-
2200	with forklift pockets	197 x 134 x 92	211 x 148 x 100	90	1210	7181	-
3300	standard	190 x 190 x 103	204 x 204 x 104	129	1153	7168	-
4500	large container, above ground		449 x 111 x 121	150	-	7791	-
4500	large container, below ground		449 x 111 x 121	130	-	7792	-

Suitable steel feet or castor frame see page 243.

## ACCESSORIES FLAT LID

Version for size	External dimensions cm (l x w x h)	Weight approx. kg	Order no.
 100	89 x 59 x 4	2	1168
200 flat	123 x 64 x 4	2.5	1169
200 high	89 x 59 x 4	2	1168
300	120 x 72 x 4	3.5	1170
400	120 x 80 x 4	4	1171
500 flat	154 x 89 x 4	8	6956
550	134 x 98 x 6	5.5	1172
700	134 x 98 x 6	5.5	1172
1100	163 x 120 x 6	6.5	1173
1500	183 x 140 x 6	10.5	1174
2200	212 x 149 x 6	15	1175
3300	205 x 205 x 6	23	1979
4500 large container	453 x 113 x 11	30	7819

flat lid for large container with integrated quick lock lid dia. 380 mm

## ACCESSORIES STEEL BASE FRAME (ALSO FOR GRIT CONTAINER)

Version for size	Weight approx. kg	Order no.
 100	8	7784
200 flat	12	7785
200 high	10	7786
300	12	7787
400	12	7788
550	16	7789
700	16	7790
1100	25	7591
1500	42	8010
2200	48	8011

galvanised steel base frame for more secure support

## ACCESSORIES CASTOR FRAME (CASTOR = CA; ALSO FOR GRIT CONTAINER)

Version for size	Weight approx. kg	Order no.
 100 (LR ø 100 mm) PP	9	7812
200 flat (LR ø 100 mm) PP	14	7813
200 high (LR ø 100 mm) PP	9	7814
300 (LR ø 100 mm) PP	14	7815
400 (LR ø 100 mm) PP	14	7816
550 (LR ø 125 mm) PP	18	7817
700 (LR ø 125 mm) PP	18	7818
1100 (LR ø 150 mm) PA	25	8012
1500 (LR ø 200 mm) PA	42	8013
2200 (LR ø 250 mm) PA	48	8014

galvanised castor frame for mobile use

2 castors with additional turning and steering stops

# Forkliftable rectangular container PG 8



## Forkliftable rectangular container

- with integrated forklift pockets, suitable for pallet trucks and forklifts
- made of highly impact resistant, damage tolerant resin (see also catalogue page 251)



Can be stacked with closed lid (stacking lid as accessory).



Can be driven under with pallet truck and forklift (stacking lid as accessory).

## RECTANGULAR CONTAINER GRP, FORKLIFTABLE

Capacity L	Internal dimensions cm top (l x w x h)	External dimensions cm top (l x w x h)	Weight approx. kg	Order no. green	Order no. grey
200 high	80 x 50 x 54	87 x 57 x 64	9.7	10582	10584
400	112 x 72 x 50	119 x 79 x 60	15	10583	10585

## ACCESSORIES

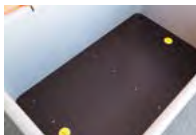

Description	Version for size	External dimensions cm top (l x w x h)	Capacity kg	Weight approx. kg	Order no.
 Stacking lid*	200 high	89 x 60 x 9	200	3	10586
	400	121 x 82 x 11	400	6.3	10587
 Insert plate	200 high	75 x 45 x 3	200	3	10739
	400	107 x 67 x 3	400	5.4	10740



\* Stacking lid in grey on request.



# Rectangular containers PG 8

## ACCESSORIES

Description	Thread	without mounting	with mounting on the tank
		Order no.	Order no.
 <p>Screw through threaded connector (brass) with external thread, 2 lock nuts</p>	¾"	1393	8843
	1"	1394	8844
	1¼"	1395	8845
	1½"	1396	8846
 <p>Screw in threaded connector (brass, nickel-plated) with external thread, food safe</p>	¾"	1397	8847
	1"	1398	8848
	1¼"	1399	8849
	1½"	1500	8850
 <p>Screw in threaded connector (plastic) with external and internal threads</p>	2"	1501	8851
	ET 1" IT ½"	1515	8852
	ET 1¼" IT ¾"	1516	8853
	ET 1¼" IT 1"	1517	8854
	ET 2" IT 1½"	1518	8855
	ET 2¾" IT 2"	1519	8856

Description	Thread	Order no.
 <p>Discharge valve (brass, nickel-plated) with internal thread at both ends</p>	¾"	1303
	1"	1304
	1¼"	1305
	1½"	1306
	2"	1307
 <p>Plastic ball valve (PVC) internally threaded</p>	1"	6426
	1½"	6428
	2"	6429
 <p>Spindle valves (plastic) with ext. thread matched to screw in threaded connector</p>	3"	6430
	½"	1314
	¾"	1315

Description	Order no.
 <p>1 kg repair pack pre-accelerated resin, hardener, glass-fibre, brush</p>	neutral
	1617
<p>Polyester adhesive pack (1 kg adhesive resin, hardener)</p>	green
	1618
	1619



Nestable while on their sides for space-saving storage and easy separation

# One CEMbox – many benefits



stack-able

All models are moulded with lugs and recesses that allow them to be stacked safely and securely.



load-able

The lid is double-walled, therefore particularly stable and robust, and sealed to provide effective protection against the elements.



carry-able

With a CEMbox you have everything in hand. Ergonomically moulded carry handles allow for comfortable lifting by one or two people.



access-able

The 750 litre CEMbox with a side door offers easy and comfortable access from street level, when mounted on a vehicle.

## The CEMO tool box for professionals

When you store your goods in transit in a CEMbox you can rest assured that they are safe and protected against outside influences. The CEMbox – the small, smart container for goods in transit.



transport-able

The CEMbox's robust design allows an impressive load bearing capacity of up to 400 kg. Except for the 150 litre box, moulded forklift pockets make handling easy.



crane-able

Crane frame with pivoting crane eyelets (for CEMbox 400 L and 750 L for use with cranes)

The CEMbox can be equipped with a frame to allow them to be suspended and lifted around a work site using a crane (except 150 litre box).



lock-able

Adjustable tappet latches with padlock loops help prevent unwanted interference with the contents of your CEMbox.



roll-able

The trolley version of the 150 litre CEMbox provides a convenient solution for movement on site.



label-able

The 150 and 400 litre versions have a moulded recess to allow for marking and labelling.



adapt-able

A range of useful accessories allows the Cembox to be used in a variety of ways. Compartment dividers, installable and stackable trays, foam inserts and more provide for extensive individual adaptation.



# CEMbox PG 8

## CEMbox, PE

- grey/orange or yellow box made of high-grade PE
- for transport and storage of tools and small parts
- ideal length for shovels
- side door optional (750 L box)
- optimal dimensions for flatbed vehicles
- stackable, with locating lugs and recesses
- forklift pockets (except 150 L box)
- integrated handles
- cover stop

- 3 toggle latches (750 L box) or 2 toggle latches (150 L, 250 L or 400 L box) made of stainless steel
- space for label pocket (150 L and 400 L box)
- water ingress prevented by integral seal around entire lid
- partition that fits in the grooves of the toolbox as an accessory

- insert tray accessory for delicate tools (e.g. spirit level)

## CEMbox suitable for use with cranes:

- reinforced design with crane lugs and sturdy crane frame (250 L, 400 L and 750 L box)



CEMbox 750 L, anthracite



Video  
CEMbox  
Trolley  
Offroad



CEMbox 750 L for use with cranes



CEMbox 250 L, yellow (other colours available for orders of 50 units or more)









CEMbox trolley 150 L offroad, grey/orange





Description	Capacity L	External dimensions cm (l x w x h)	Internal dimensions cm (l x w x h)	Weight approx. kg	Individual load-bearing capacity in kg	Load-bearing capacity for double stacking in kg	Order no.
CEMbox 150, grey/orange	150	80 x 60 x 53	66 x 45 x 38	14	100	100	10330
CEMbox 150, yellow	150	80 x 60 x 53	66 x 45 x 38	14	100	100	10132
CEMbox Trolley 150, grey/orange	150	80 x 60 x 53	66 x 45 x 38	15	100	100	10331
CEMbox Trolley 150, yellow	150	80 x 60 x 53	66 x 45 x 38	15	100	100	10133
CEMbox Trolley 150 offroad, grey/orange	150	88 x 73 x 61	66 x 45 x 38	19	60	-	11284
CEMbox 250, grey/orange	250	120 x 60 x 54	107 x 45 x 38	18	200	100	10332
CEMbox 250, yellow	250	120 x 60 x 54	107 x 45 x 38	18	200	100	8615
CEMbox 250, for use with cranes, grey/orange	250	124 x 60 x 57	107 x 45 x 38	33	100	100	10333
CEMbox 400, grey/orange	400	120 x 79 x 75	107 x 65 x 58	30	250	150	10334
CEMbox 400, for use with cranes, grey/orange	400	120 x 81 x 75	107 x 65 x 58	60	200	150	10961
CEMbox 750, anthracite	750	170 x 84 x 80	156 x 70 x 63	42	400	200	8490
CEMbox 750, grey/orange	750	170 x 84 x 80	156 x 70 x 63	42	400	200	10335
CEMbox 750, grey/orange, with side door 50 x 45 cm (b x h)	750	170 x 84 x 80	154 x 70 x 63	43	400	200	10336
CEMbox 750, for use with cranes, grey/orange	750	170 x 86 x 80	156 x 70 x 63	75	200	200	10337
CEMbox 750, for use with cranes, grey/orange, with side door	750	170 x 86 x 80	154 x 70 x 63	76	200	200	10338

Other colours available on orders of more than 50 units.

## ACCESSORIES FOR CEMBOX 150 L AND 250 L

Description	CEMbox 150 L		CEMbox 250 L	
	Dimensions cm (l x w x h)	Order no.	Dimensions cm (l x w x h)	Order no.
 Insert for delicate tools, long, PE	73 x 15 x 6	8955	113 x 15 x 6	8170
 Partition	54 x 37	8956	54 x 38	8171
 Insert, stackable	43 x 28 x 19	10016	43 x 28 x 19	10016
 Flatbed mounting kit	-	8666	-	8666
 Insert of polyurethane foam, cube size: 22 x 22 x 50 mm	66 x 48 x 40	10048	-	-
 Anti-slip mat, oil and weather-resistant	60 x 80	10166	80 x 120	10167

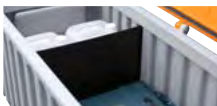
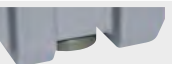
## ACCESSORIES FOR CEMBOX 400 L AND 750 L

Description	CEMbox 400 L		CEMbox 750 L	
	Dimensions cm (l x w x h)	Order no.	Dimensions cm (l x w x h)	Order no.
 Insert for delicate tools, long, PE	113 x 15 x 6	8170	160 x 15 x 6	8492
 Insert, metal	-	-	67 x 74 x 17	8688
 Rubber mat for metal insert	-	-	66 x 73	8689
 Partition	73 x 40	8957	76 x 60	8493
 Flatbed attachments	-	10111	-	8494
 Anti-slip mat, oil and weather-resistant	80 x 120	10167	80 x 180	10166 + 10167
 Set of wheels, consisting of 4 solid rubber wheels (Ø 125 mm) with rotation and swivel brake, includes mounting accessories, maximum load 200 kg	-	11491	-	11491

## Vehicle storage box PG 8

- grey container made of PE
- for safe transport and storage of tools and building materials
- lockable
- stackable inside one another
- can be handled using a forklift or crane grab
- example application: construction industry, landscaping and handcraft



Easy loading and unloading with forklift pockets

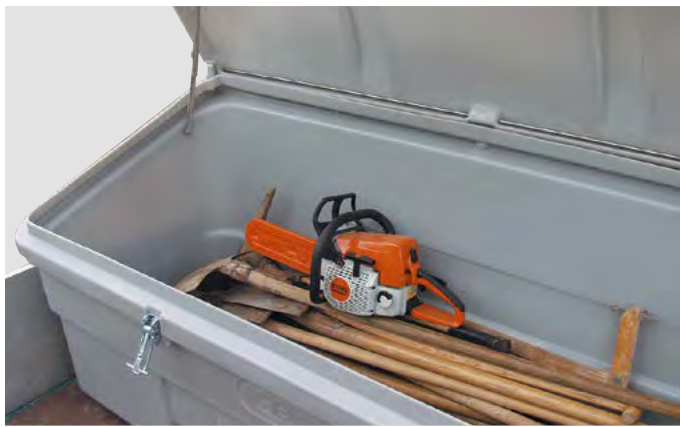

Secure storage of tools and building materials



Hinged steel lid stay

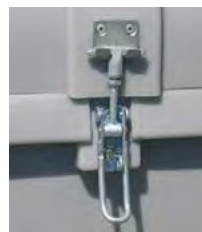

Lockable lid



Platform fastening (reinforcement)



Platform fastening

Description / capacity L	Dimensions in cm (l x w x h)	Weight approx. kg	Order no.
Vehicle storage box 750	184 x 74 x 94	40	7841

### ACCESSORY

Description	Order no.
Platform fastening kit (for fastening on 2 corners)	7883



## General-purpose box PG 8

- container and lid are made from glass-fibre reinforced plastic (GRP)
- weather-proof and durable
- lockable
- ideally suited for the storage of tools and small parts
- with integrated forklift pockets, suitable for trucks and forklifts
- can be stacked with closed lid
- cover with gas struts
- flat internal base thanks to insert plate
- made of highly impact resistant, damage tolerant resin (see below)

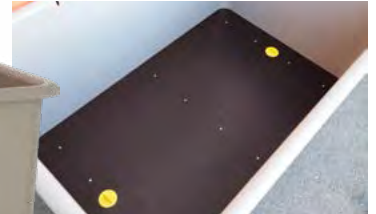

Level internal base thanks to insert plate

Description	Capacity L	External dimensions cm (l x w x h)	Internal dimensions cm (l x w x h)	Weight approx. kg	Order no.
General-purpose box 200	200	89 x 60 x 69	75 x 45 x 51	16	10737
General-purpose box 400	400	121 x 82 x 68	107 x 67 x 47	27	10738

### ACCESSORY

Description	Order no.
Padlock, galvanised	1490

## Project

### DAMAGE-TOLERANT RESIN FORMULATIONS FOR GRP RECTANGULAR CONTAINERS

As part of the development of more damage-tolerant flush-mounted GRP rectangular containers, the project is concerned with the modification of the matrix system's count and attempts to increase the impact resistance of these components in a targeted manner. Important process-relevant parameters such as viscosity and pot life or properties of the end product (shrinkage, residual stresses, surface finish) should not be affected.

Another critical factor is the fibre-matrix adhesion, which has to guarantee the actual shear force absorption under abrupt stress

**The aim of the project is to develop damage-tolerant rectangular containers by means of a targeted modification of the resin matrix to increase impact resistance.**

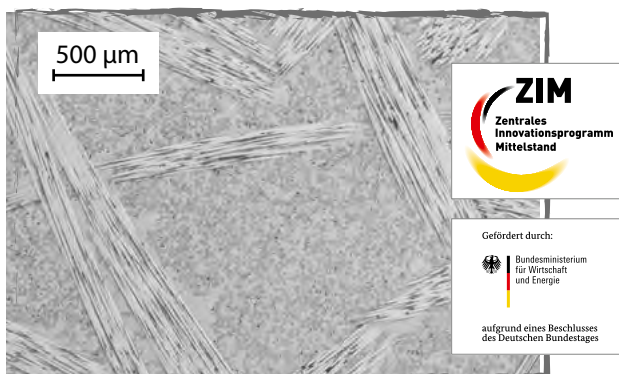

Microsection of a toughened, unsaturated polyester resin GRP system



GRP rectangular container 400 L, with or without integrated forklift pockets

## Logistics box PG 8

- optimal storage and transport system
- PE plastic high density (HDPE)
- extremely acid-resistant
- stackable and safe for transport
- food safe

### Food-safe design:

Container with foodstuff symbol as per Regulation (EU) No. 10/2011



Logistics box 300 L



Logistics box 525 L



Logistics box 610 L

Description / capacity L	External dimensions cm (l x w x h)	Load-bearing capacity, individual, kg	Max. boxes stacked	Load-bearing capacity complete, stacked, kg	Weight approx. kg	Order no.
Logistics box 300, with 4 feet	100 x 63.5 x 64.5	150	5	750	14.3	10158
Logistics box 525, with 2 runners	120 x 80 x 80	350	8	2800	30	8613
Logistics box 610, with 3 runners	120 x 100 x 76	450	8	3600	37	8085

## ACCESSORIES

Description	External dimensions cm (l x w x h)	Weight approx. kg	Order no.
Lid for box 300	103 x 65 x 7.5	5	10159
Lid for box 525	121.5 x 81.5 x 6	6	8614
Lid for box 610	121.5 x 101.5 x 6	7	8086

## Go-Box PG 8

- for grit, sand, absorbents, etc.
- for indoor and outdoor use and storage
- sturdy rubber wheels
- angled lid so that water runs off
- with stainless steel toggle latch
- can be locked with a padlock (not included), see page 260
- user-friendly, ergonomic handle
- 70 L capacity
- lid in a vertical position for filling/emptying
- easy to handle thanks to sophisticated balance
- easy to clean
- made from chemical-resistant PE – 100 % recyclable
- partition for insertion into the grooves of the Go-box as accessories



Accessory: partition

Video Go-Box



Description / capacity L	Dimensions cm (h x w x d)	Weight approx. kg	Order no.
Go-Box 70	107 x 59 x 39	10	11285

## ACCESSORIES

Description	Dimensions cm (h x w)	Order no.
Partition for Go-Box 70	40 x 32	11286

## Boot cleaner Premium PG 8

- made from high quality UV stabilised polyethylene
- equipped with three fixed brushes and one movable brush
- water connection 1/2"
- stainless steel fittings
- brush holder with integral hand washing function
- with integral sump for dirty water collection and run-off, optionally on the right or left



Accessory: scraper grate for coarse dirt

ground anchor kit

with integral handles



Integral sump to collect dirty water



hand washing function



non-slip boot support surface while cleaning with hand brush

Description	Dimensions cm (l x w x h)	Weight approx. kg	Order no.
Boot cleaner Premium	53 x 49 x 88	13	11496
Accessory: scraper grate for coarse dirt	43 x 60 x 14.5	5	11497
Accessory: ground anchor kit	-	-	11507

## Boot cleaner ECO PG 8

- frame made of stainless steel
- equipped with three fixed brushes
- 1/2" water connection (Gardena)
- stainless steel pipes
- with holder



Accessory: scraper grate for coarse dirt

Boot cleaner ECO



Description	Dimensions cm (l x w x h)	Weight approx. kg	Order no.
Boot cleaner ECO	33 x 33 x 82	5.6	10588
Accessory: Scraper grate for coarse dirt	28 x 40 x 4	1.1	10589

## Rinsing tray PG 8

- from highly resistant GRP
- impact and scratch-proof, as well as resistant to high temperatures
- discharge with plug
- 1 1/4" with discharge connection



Rinsing tray 75

Rinsing tray 100

Description / capacity L	Dimensions cm (l x w x h)	Order no.
Rinsing tray 75	80 x 55 x 30	1086
Rinsing tray 100	105 x 55 x 30	1087

## ACCESSORIES

Description	Dimensions cm (l x w x h)	Order no.	
Wall bracket, galvanised, 46 cm wide		1088	
Floor frame from galvanised steel tube			
	for rinsing tray 75 L	83 x 56 x 81	1089
	for rinsing tray 100 L	108 x 56 x 81	1090
Drainage hose plastic with screw connector		1091	





# WINTER SERVICE | SPREADERS





# CEMO grit bin

**CEMO ensure that your grit is well protected in all weather and ready for action when needed.**

- ✓ Material: GRP – durable, tough, rustproof, resistant to salt
- ✓ 20-year service life, 10-year warranty (!)
- ✓ Impact-resistant, able to withstand a blow from a hammer, and inherently robust
- ✓ Temperature- and UV-resistant
- ✓ Protected against water and humidity
- ✓ Well-conceived design for ease of use

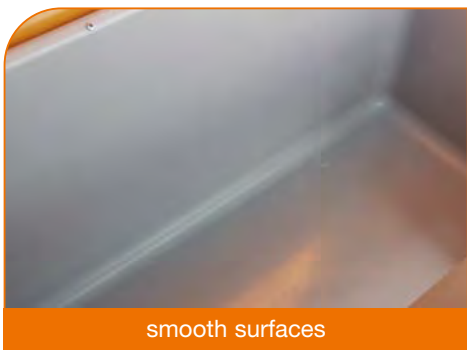

smooth surfaces

Less dirt thanks to smooth external walls (dirt not allowed to build up); no residues left behind after draining and easy to clean thanks to smooth internal walls in the container.



clean closing

Long-lasting, secure closure thanks to the moulded container edge and overhang which prevent the ingress of dirty water and moisture.



stackable

"Sideways stackable" for space-saving storage and easy separation.

Video  
grit bin PLUS3



vandalism-proof lid

Extremely impact-resistant and inherently robust material ("hammer test"), plus increased wall strength (for 550 L and 700 L containers).

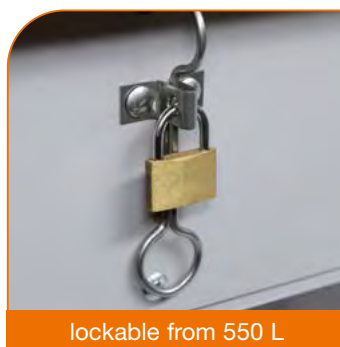

lockable from 550 L

Easy to open from outside and inside with a self-locking stainless steel spring closure. Lockable by means of a padlock (not supplied)



tool-free removal from 550 L

The lid can be removed without tools. It can be locked simply using removable retaining straps.



## CEMO grit bin PLUS3

The new grit bin generation Plus3 adds three further plus points to the benefits of our GRP grit bins in terms of handling and assembly.

The additional benefits of the **Plus3** grit bin:

- ① can be stacked with closed stacking lid
- ② forkliftable
- ③ lid can be removed without using tools



Can be stacked with closed stacking lid.



Can be forkliftable with lifting truck and forklift (version 200 L and 400 L).



The lid can be removed without tools. It can be locked simply using removable support bar (400 L).



## Grit bin PLUS3 PG 8

As the market leader for grit bins, we receive extensive feedback and a large number of requests. For many local authorities, simple use and handling are paramount. The ability to move with a forklift and stack the containers makes it so much easier to move grit bins in and out of storage and saves time and space.

In addition, the toolless assembly of the very robust lid has been significantly simplified.

The new grit bin generation **Plus3** adds three further plus points to the benefits of long-life GRP grit bins in terms of handling and assembly.

### Grit bins Plus3

The additional benefits of the Plus3:

- forkliftable (optional)
- can be stacked with closed lid (optionally lockable with padlock, for accessories see page 260)
- lid can be removed without using tools
- with support strut for lid (400 L version)
- strong and robust lid shape



Yellow base and yellow lid version (200 L) without access chute

200 L



400 L forkliftable with access chute lockable with optional padlock



Can be forkliftable with lifting truck and forklift



Can be stacked with closed lid



### GRP GRIT BIN PLUS3

Capacity L	Dimensions in cm (l x w x h)	With or without chute	With or without forklift slots	Weight approx. kg	Container grey lid orange Order no.	Container green lid orange Order no.	Container yellow lid yellow Order no.
100	89 x 60 x 34	without	without	8.3	10564	10573	-
200	89 x 60 x 64	without	without	11.3	10565	10574	10974
200	89 x 60 x 64	with	without	12.5	10566	10575	-
200	89 x 60 x 69	without	with	12.8	10567	10576	-
200	89 x 60 x 69	with	with	14	10568	10577	-
400	121 x 82 x 67	without	without	21.4	10569	10578	10975
400	121 x 82 x 67	with	without	21.6	10570	10579	-
400	121 x 82 x 68	without	with	21.4	10571	10580	-
400	121 x 82 x 68	with	with	22.6	10572	10581	-

### ACCESSORY FOR FORKLIFTABLE GRIT BIN

Description	Version for size	External dimensions cm (l x w x h)	Capacity kg	Weight approx. kg	Order no.
 Floor plate	200	75 x 45 x 3	200	3	10739
	400	107 x 67 x 3	400	5.4	10740

## Grit bin PG 8

- container and lid from glass-fibre reinforced plastic, GRP
- GRP grit bins are 100% corrosion- and weather-proof
- stainless steel spring closure, self-closing
- simple opening from the outside and inside
- simple, safe handling
- space and time-saving to store and remove from storage (stackable)
- simple assembly, supplied with lid unassembled
- from 550 L - 700 L with removable retaining straps for lids
- from 1100 L to 2200 L (standard) with stainless steel locking lid stays



Colour combination grey/orange with chute



Colour combination green/orange with chute



## GRIT BIN

Capacity L	Dimensions in cm (l x w x h)	with or without chute		Weight approx. kg	Container grey, lid orange	Container green, lid orange
		without	with		Order no.	Order no.
550	134 x 99 x 78	without	with	26	10833	10837
				28	10834	10838
700	134 x 99 x 96	without	with	30	10835	10839
				32	10836	10840
1100	163 x121 x101	without	with	50	7435	7441
				52	7436	7442
1500	184 x143 x104	without	with	70	7437	7443
				72	7438	7444
2200	213 x152 x124	without	with	92	7439	7445
				94	7440	7446

## ACCESSORIES STEEL BASE FRAME GALVANIZED, FOR STABLE FOOTING PG 8

Version for size	Weight approx. kg	Order no.
	100	7784
	200	7786
	400	7788
	550	7789
	700	7790
	1100	7591
	1500	8010
	2200	8011

## ACCESSORIES CASTOR FRAME GALVANIZED, FOR MOBILE USE (CASTOR = CA) PG 8 GALVANIZED ROLLER STAND FOR MOBILE USE, 2 CASTORS WITH SWIVEL AND ROTATION BRAKE

Version for size	Weight approx. kg	Order no.
	100 (CA ø 100 mm)	PP 9 7812
	200 (CA ø 100 mm)	PP 9 7814
	400 (CA ø 100 mm)	PP 14 7816
	550 (CA ø 125 mm)	PP 18 7817
	700 (CA ø 125 mm)	PP 18 7818
	1100 (CA ø 150 mm)	PA 25 8012
	1500 (CA ø 200 mm)	PA 42 8013
	2200 (CA ø 250 mm)	PA 48 8014



## Grit bin PG 8

### GRP grit bin "V" with anti-vandalism lid

- particularly impact resistant and form-retaining material ("hammer test")
- increased wall thickness (for container sizes 400, 550 and 700 L)

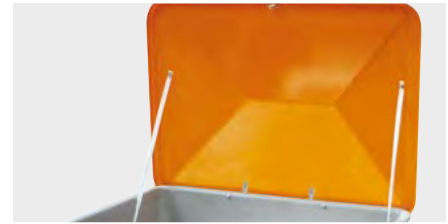

### GRP GRIT BIN "V" WITH ANTI-VANDALISM LID

Capacity L	Dimensions in cm (l x w x h)	With or without chute	Weight approx. kg	Container grey, lid orange Order no.	Container green, lid orange Order no.
550	134 x 99 x 78	without	27	10896	10900
		with	29	10897	10901
700	134 x 99 x 96	without	31	10898	10902
		with	33	10899	10903

### ANTI-VANDALISM LID FOR UPGRADING EXISTING GRP GRIT BINS WITH ROOF-SHAPED LID

For container size	Order no.
400	8087
550 and 700	10904

### ACCESSORIES FOR GRP GRIT BIN PG 8

Description	Order no.
Padlock, galvanised	1490
Hinged steel lid stay, complete installation kit, for containers of 700 litres capacity. Note: lid can only be dismantled from container with tools, except for grit bin Plus3.	3212
Sticker "Salt / Grit"	5 pcs 8625
(other language options upon request)	10 pcs 8626

## GO-BOX PG 8

- for grit, sand, absorbents, etc.
- for indoor and outdoor use and storage
- sturdy rubber wheels
- angled lid so that water runs off
- with stainless steel toggle latch
- can be locked with a padlock (not included)
- user-friendly, ergonomic handle
- 70 L capacity
- lid in a vertical position for filling/emptying
- easy to handle thanks to sophisticated balance
- easy to clean
- made from chemical-resistant PE – 100 % recyclable
- partition for insertion into the grooves of the Go-box as accessories



Accessory: partition

Video Go-Box

Description / Capacity L	Dimensions in cm (h x w x d)	Weight approx. kg	Order no.
Go-Box 70	107 x 59 x 39	10	11285
Go-Box in yellow, see page 212	107 x 59 x 39	10	11449

### ACCESSORY

Description	Dimensions in cm (h x d)	Order no.
Partition for Go-Box 70	40 x 32	11286

# Grit bin handling PG 8

## Loading frame for loading and emptying of filled GRP grit bins with a truck crane

This innovative handling concept was developed in conjunction with municipal authorities. Based on the grit bin, it is now possible to make full use of the advantages (lid removable without tools). Using the hydraulic loading bracket, the grit bin can now be picked up, emptied and stored by a single person. This reduces time space and personnel costs.



hydraulic loading bracket

grit bin be picked up, emptied and stored by a single person

reducing time, space and personnel costs to a minimum

①



Engaging the loading frame from the side after removal of the removable lid (shown with 700 L grit bin)



Lifting the container (shown with 200 L the grit bin)



Tipping the grit out onto a truck platform (shown with 700 L the grit bin)

②



Loading frame hydraulic, tilting with auxiliary frame, for grit bin 200 L

Loading frame hydraulic, tilting, for grit bin 400 L



Model		Weight approx. kg	Order no.
① Loading frame, hydraulic, tilting	for grit bin 400, 550 and 700 L	120	7738
① Auxiliary frame, for loading frame, hydraulic, tilting (7738)	for grit bin 200 L	8	7739
② Loading frame, hydraulic, tilting	for grit bin 400 L	120	10728
② Auxiliary frame, for loading frame, hydraulic, tilting (10728)	for grit bin 200 L	9	10729
	for grit bin 200 L	15	1833
	for grit bin 400 L	30	1832
	for grit bin 550 and 700 L	40	2109

## GRP snow shovel PG 8



### GRP snow shovel

- high-quality GRP snow shovel
- solid aluminum edge (replaceable)
- absolutely resistant to corrosion
- smooth surface prevents adhesion of snow
- high, strong raised sides
- double-arc'd shaft with D handle for ergonomic and efficient use

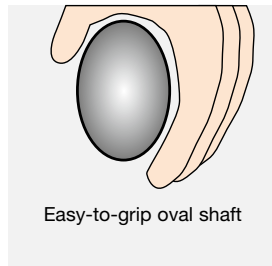

Solid aluminum edge (replaceable)



Description	Length with shaft cm	Dimensions of shovel cm (w x h)	Order no.
GRP snow shovel	152	56 x 36	10064
10 pack* of GRP snow shovels 10064			10066

\* 10 x snow shovel blades and 10 x snow shovel handles, packed in two cartons.



## Snow plough PG 8

With its adjustable-length handle, the snow plough lets you clear pavements and other areas of snow without straining your back.

- innovative snow clearing tool, "Made in Germany", with long service life
- solid, powder-coated steel tube construction
- ribbed stainless steel plough blade, cushioned with disc springs
- pneumatic wheels mounted on roller bearings, with lug tread dia. 260 mm
- adjustable blade position
- simple clearing angle adjustment without bending over

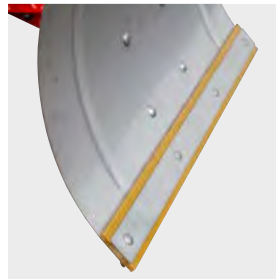

Replaceable stainless steel scrape rail or PU edge strip (accessories)



Control for three/five blade positions



Description	Dimensions cm (l x w x h)	Weight approx. kg	Order no.
Snow plough	110 x 74 x 90	12	10743

### ACCESSORY

Description	Order no.
PU edge strip	10744

## PP shovels PG 8

- corrosion resistant shovels made of polypropylene (PP)
- ideal for handling corrosive materials such as grit used on the roads
- low weight
- high durability
- non-adhesive surface
- 100 % corrosion-proof
- UV-stabilised and virtually shatterproof material
- used in agriculture, municipalities and the food industry



Description	Shovel dimension cm (l x w x h)	Overall length cm	Weight approx. kg	Order no.
Hand scoop medium PP01	19 x 14 x 7,5	31	0.2	7964
Hand scoop large PP02	23 x 17 x 9	36	0.3	7965
General purpose shovel D-grip standard PP03	31.5 x 25 x 4	98	1.1	7966
General purpose shovel D-grip medium PP04	35 x 26 x 8	105	1.4	7967

# Grit spreaders PG 8

## Spreader with composite frame

The use of new composite plastics enables the integration of many functions into a single component.

- for use in domestic and commercial areas
- durable design
- composite frame and PE hopper
- stainless steel axles
- rugged transmission
- retractable support foot
- spreading quantity adjustable with fixed stop
- supplied in prefabricated assemblies

## Spreader SW 20-C and SW 35-C

- for use in tough winter conditions
- for various spreading materials
- with robust agitator finger
- adjustable stainless steel dual handle with three height settings
- with adjustable spreading width limiter
- with strainer insert
- pneumatic rubber tyres with winter tread

## Spreader SW 20-light

- for seeds and fertiliser
- adjustable galvanised steel dual handle with three height settings
- plastic wheels

SW 35-C



SW 20-light



Retractable foot support



Filling strainer (SW 20-C and SW 35-C)



Spreading quantity adjustable with fixed stop



Dual handle, three height settings







Adjustable spread width limiter at SW 20-C and SW 35-C

## SPREADER WITH COMPOSITE FRAME AND PE CONTAINER

Description	Capacity L	Spreading width m	Spreading steps	Weight approx. kg	Order no.
SW 20-light for medium spreading areas	20	1 up to 4	6	9	10718
SW 20-C for medium spreading areas	20	1 up to 4	6	10	10642
SW 35-C for medium spreading areas	35	1 up to 4	6	11	10643

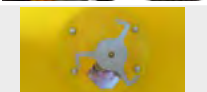
## ACCESSORIES

Description	Order no.
 Cover for SW 20-C and SW 20-light	7884
 Cover for SW 35-C	7885
 Spreading width limiter for SW 20-light	10720
 Eccentric agitator for poorly-flowing salt and grit for SW 20-light, SW 20-C, SW 35-C and SW 50-E	10998

# Grit spreaders PG 8

## Spreader SW 50-E

- for commercial and domestic use
- suitable for a variety of gritting materials and spreading widths
- quick and easy assembly
- robust construction
- stainless steel axles
- stainless steel frame
- handle has three length adjustments and continuously adjustable in height
- hinged pedestal
- gearbox drive disengagement on wheel



SW 50-E

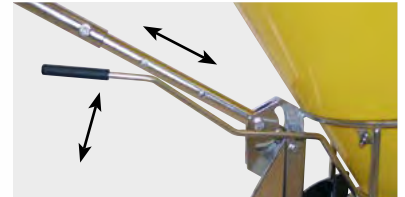

Volume adjustment lever and adjustable T-bar handle

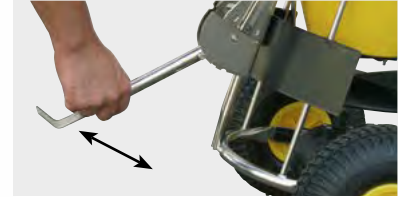

Hinged support foot



Wheel shutoff



Cover (accessory)



Additional anti-compression assembly

## Drop spreader KS 35-E

- for domestic and commercial use
- for various types of spreading material such as salt, grit, sand, oil binding agents, seed or fertilizer
- robust stainless steel agitator shaft with interlocked teeth
- accurate spread width of 60 cm
- quantity to be spread can be precisely and continuously adjusted via the snail cam
- quick and easy assembly
- all parts that come into contact with media are made from stainless steel or plastic
- hopper made of corrosion-proof polyethylene
- powder-coated steel frame
- retractable support foot
- adjustable-length T-bar handle
- pneumatic rubber tyres with winter or rough terrain treads
- axle divided in the middle, moves around corners easily
- agitator vanes adjustable



Adjustable – length handle, large operating lever



Hopper attachment 25 L (accessory)



Rugged agitator shaft, axle divided in the middle



Cover (accessory)



Uniform scatter, accurate spread width, adjustable agitator vanes



Eccentric disk

### Description

SW 50-E, for medium spreading areas, 6 spreading steps, yellow plastic hopper, stainless steel tubular frame, pneumatic rubber tyres with winter tread, robust gearing, spreading quantity regulator, adjustable handle, additional anti-compression assembly, axle bearing suitable for lubrication and wheel shutoff . Supplied as pre-assembled modules.

KS 35-E drop spreader

Capacity L	Spreading width m	Weight approx. kg	Order no.
50	1 up to 4	14	10742
35	0.6	16.5	8487

## ACCESSORIES

### Description

Description	Order no.
Cover for SW 50-E	10021
Cover for KS 35-E	8495
Hopper attachment 25 L for KS 35-E	11043



## 60 L Spray Caddy PG 8

### 60 L Spray Caddy for liquid de-icing products

- electric pump 12 V, approx. 6 l/min
- LiFePO<sub>4</sub> battery with charger
- flow-activated pump
- 8 m spiral hose
- spray lance with flat jet nozzle
- suitable for commercially available liquid, water-based de-icing products



Spiral hose, electric pump and battery with charger



Description	Capacity L	Dimensions cm (l x w x h)	Weight approx. kg	Order no.
Spray Caddy	60	90 x 52 x 37	15	10863

## Grit spreader PG 8

### Grit spreader SW 130 with PE hopper

- for commercial and domestic use
- suitable for different gritting materials and spreading widths
- quick and easy assembly
- robust construction



Rugged transmission with aluminum housing

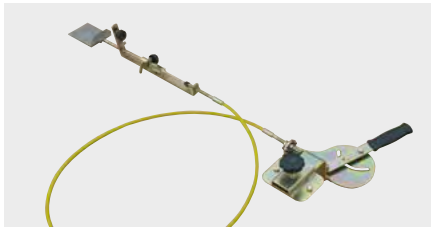

Accessory remote control



Disengageable gear



SW 130

Description	Capacity L	Spreading width in m	Spreading steps	Weight approx. kg	Order no.
SW 130 for large spreading areas, with robust gearbox and aluminium housing, yellow plastic hopper with robust flap lid, painted tubular steel frame, pneumatic rubber tyres, volume regulator. Supplied as pre-assembled modules. Drawbar parallel adjustable for height included. Gearing disengageable. Max. speed 6 km/h.	130	up to 5	10	39	10063

## ACCESSORY

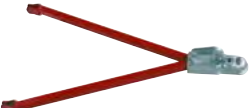
Description	Order no.		
 <p>Spreading width limiter for SW 130</p>	7291		
 <p>Drawbar with ball coupling for SW 130</p>	8621		
Description	Length from operating lever m	Weight approx. kg	Order no.
Remote control for spreader SW 130	2.0	3.0	8289

# Towable grit spreaders PG 8

## Towable spreader SW 200 and SW 300 with PE hopper

- for commercial and domestic use
- suitable for different gritting materials and spreading widths
- robust construction
- gearbox with aluminium housing, can be disabled
- sturdy, greasable wheel bearings
- stainless steel frame
- all parts that come into contact with the media are stainless steel or plastic
- spreading amount, spreading direction and spreading width can all be set as required (optional)
- 16 x 6.5 wheels with pneumatic rubber tyres, winter profile
- parallel height-adjustable drawbar
- lighting with 7-pin plug
- supplied as pre-assembled modules



SW 200



Additional anti-compression



Spreading quantity control



Disengageable gear



Stainless steel spreader disc, adjustable







Robust wheel bearing



SW 300

Description	Capacity L	Spreading width in m	Spreading steps	Weight approx. kg	Order no.
SW 200 for large spreading areas	200	up to 5	10	80	10205
SW 300 for large spreading areas	300	up to 5	10	85	10206

## ACCESSORIES

Description	Order no.
 <p>Spreading width limiter adjustable, galvanised, for SW 200 and SW 300</p>	10207
 <p>Remote control for spreaders SW 200 and SW 300 length of bowden cable: 2.0 m</p>	10208
 <p>Cover for SW 200 and SW 300</p>	10210
 <p>Ball coupling 2", galvanised, for SW 200 and SW 300</p>	10209

# Mounted spreaders PG 8

## Mounted spreader SA 130



- for large spreading areas
- yellow plastic hopper with rigid flap lid
- painted tubular steel frame
- with three point attachment (A=410/526mm, B= dia. 22mm)
- driven using a power take-off shaft (supplied)



SA 130

Description	Capacity L	Spreading width in m	Spreading steps	Weight approx. kg	Order no.
SA 130 for large spreading areas	130	up to 5	10	35	8173

## ACCESSORIES

Description	Order no.
 Spreading width limiter for SA 130	7291
 Remote control for mounted spreader SA 130, length of bowden cable: 2.0 m, weight: 3.0 kg	8289

## Mounted spreader SA 260



- for large spreading areas
- base hopper made from painted steel
- hopper attachment made of plastic
- powder-coated steel tube frame
- 3-point attachment, category 0 + 1
- driven via power takeoff shaft (supplied as standard)



SA 260

Description	Capacity L	Spreading width in m	Spreading steps	Weight approx. kg	Order no.
SA 260 for large spreading areas	260	up to 5	10	54	10278

## ACCESSORIES

Description	Order no.
 Spreading width limiter for SA 260	10279
 Cover for SA 260	10280
 Filling sieve for SA 260	10281



## Your CEMO contact

### CEMO INTERNATIONAL AREA SALES MANAGER

export@cemo.de



**Antonio Samarzija**  
Export Director

SLO/HR/PL/RS/BiH/  
MNE/MK/KOS  
+49 (0) 172 7045617  
asamarzija@cemo.de



**Karsten Pflieger**  
Senior Area Sales  
Manager

BeNeLux, Austria,  
Asia & Oceania, Iceland  
+49 (0) 172 7447970  
kpflieger@cemo.de



**Daniel Bubeck**  
Senior Area Sales  
Manager

Switzerland, America,  
Africa, Near & Middle  
East  
+49 (0) 173 2762221  
dbubeck@cemo.de



**Pablo Martin Pineño**  
Area Sales Manager

Iberia & Latin  
America  
+49 (0) 172 7559097  
pmartin@cemo.de

### CEMO INTERNATIONAL EXPORT CUSTOMER SERVICE



**Renate Traub**  
+49 (0) 7151 9636-  
1505



**Franziska Abele**  
+49 (0) 7151 9636-  
1508



**Daniela Mayer**  
+49 (0) 7151 9636-  
1509



**Nora Offenhäuser**  
+49 (0) 7151 9636-  
1510



**Uwe Kübler**  
+49 (0) 7151 9636-  
1516



**Carmen Spießberger**  
+49 (0) 7151 9636-  
1517

### EXPORT BRANCHES

#### AUSTRIA



**COUNTRY  
MANAGER**  
**Alexander Ohler**  
+43 (0) 664 2275544  
aohler@cemo.de



**REGIONAL  
MANAGER**  
**Geoff Miller**  
+44 (0) 7579 003227  
gmiller@cemo.de



**REGIONAL  
MANAGER**  
**Giorgio Billio**  
+39 (0) 340 2942007  
gbillio@cemo.de

#### NORDICS & BALTICS



**REGIONAL  
MANAGER**  
**Frank Scharf**  
+46 (0) 73 2552329  
fscharf@cemo.de



**REGIONAL  
MANAGER**  
**Peter Timischl**  
+46 (0) 763 127228  
ptimischl@cemo.de

**The general terms of sales and delivery** for the plastics processing industry apply to all transactions. You will receive these terms when we confirm your order and they are also available at **www.cemo-group.com** "General sales terms".



**Innovative solutions**  
for Local authorities | Agriculture | Construction industry | Industry



Right to change prices and technical specifications reserved. © CEMO 0007-en 05.22